



swiss bed concept



KIDS & GUESTS

Achten Sie auf FSC®-zertifizierte Produkte | Soyez attentifs aux produits certifiés FSC® | Look for FSC®-certified products

selezione

01

MODELLAUSWAHL

Sélection du modèle | Model selection

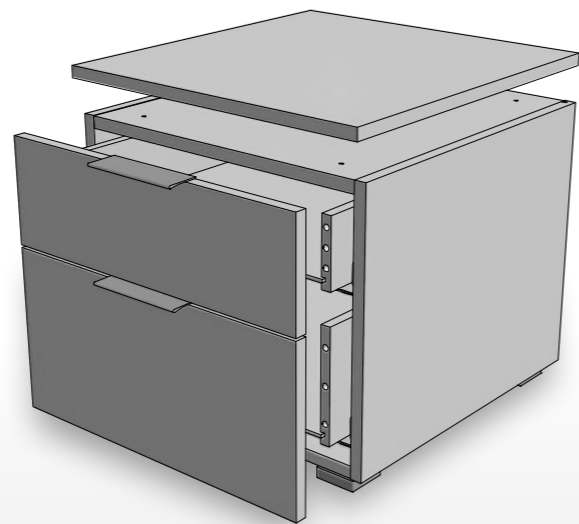

02

KORPUS

Caisson | Body



03

TOP/FRONT

Farben | Couleurs | Colours



04

GRIFFE

Poignées | Handles



Stellen Sie sich Ihr Wunsch-Beimöbel nach Ihrem Geschmack zusammen: Der Korpus (Abb. 02), in zwei verschiedenen Farbvarianten, lässt sich zu den Front- und Top-Covern (Abb. 03) in acht Holz- und Farbausführungen kombinieren. Die Beimöbel können zerlegt oder teilmontiert bestellt werden. Bei zusammengesetzten Möbeln (z. B. Qunito, Incentro, ...) muss der Deckel noch montiert werden. Bei Kommoden mit Türen ist jeweils ein Einlegeboden vorhanden, Türöffnung nach links oder rechts möglich. Zusätzliche Böden sind erhältlich.

Composez le meuble d'appoint de vos rêves selon vos goûts : Le caisson (ill. 02), disponible en 2 variantes de couleurs, peut être combiné avec les façades et couvercles supérieurs (ill. 03) en 8 finitions de bois et de coloris. Les meubles d'appoint peuvent être commandés en kits ou assemblés. Pour les meubles assemblés (p. ex. Qunito, Incentro, ...) le couvercle doit encore être fixé. Les commodes avec portes sont équipées d'une étagère, ouverture de la porte possible à gauche ou à droite. Si besoin, des étagères supplémentaires sont disponibles.

Put together the side furniture you want according to your own taste: The body (fig. 02), in two different colour versions, can be combined with the front and top covers (fig. 03) in eight wood and colour versions. The furniture can be ordered disassembled or assembled. For assembled furniture (e.g. Qunito, Incentro, ...) the top cover must still be fitted. Chests of drawers with doors have one shelf, door opening possible to the left or right. Additional shelves are available.



Kombinationsbeispiele und techn. Informationen
Exemples et informations
Examples and informations

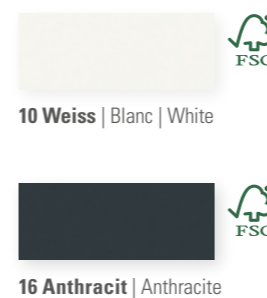

+ FÜSSE

Pieds | Feet

STANDARD



OPTION

Leg 8 cm Jone 10 cm Cila 10 cm

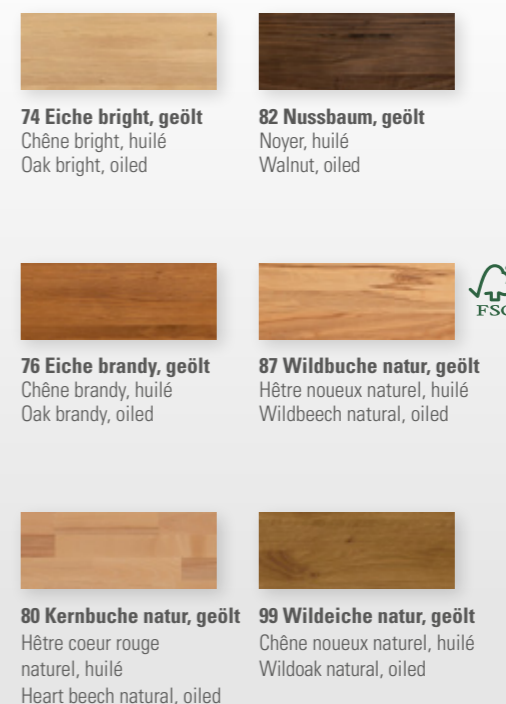
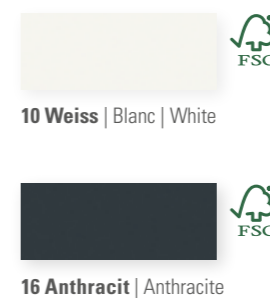

STANDARD



Alu
Griff zu Folienfronten
Poignée pour façades en mélaminé
Handle for foil fronts

STANDARD



Holzgriff zu Holzfronten
Poignée en bois pour façades en bois
Wooden handle for wooden fronts

OPTION

Rivo



Used



Anthracit

Metallgriff zu Holzfronten

Poignée en métal pour façades en bois
Metal handle for wooden fronts



| | | | | Dimension cm |
|-------------|-----------------------|---------------------------|---------------------------|--------------|
| Twia | Nachttisch, anthracit | Table de nuit, anthracite | Bedside table, anthracite | 45/49/40 |

Einfache und schnelle Handhabung – Ein hochwertiges, robustes Gästebett aus Metall in der Ausführung anthrazit. Die Federleisten aus Buchen-Schichtholz sind in den Bettrahmen integriert. Die Verarbeitung und das Material garantieren eine hohe Langlebigkeit und gute Funktionalität.

Manipulation facile et rapide - Un lit d'invité de haute qualité robuste et en métal avec finition anthracite. Les lattes à ressort en bois de hêtre stratifié sont intégrées au cadre du lit. Le traitement et le matériau garantissent une durabilité et une fonctionnalité élevée.

Easy and quick handling - A high-quality, robust guest bed made of metal in anthracite finish. The spring slats made of laminated beech wood are integrated into the bed frame. The treatment and the material guarantee a high level of durability and best functionality.

| | | | Dimension cm |
|-----------------|--|--|--|
| Monument | Aufklappbett, bestehend aus: Ober-Bett + Unter-Bett Breite Länge Mit integrierten Lattenrosten: oben 15 Latten unten 14 Latten Max. Matratzenhöhe 17 cm Metall anthracit | Lit gigogne, composé de : lit du dessus + lit du dessous Largeur Longueur Avec sommiers intégrés : en haut 15 lattes en bas 14 lattes Hauteur max. du matelas 17 cm Métal anthracite | Bed to open, consists of: upper bed + lower bed Width Length With slats integrated: above 15 slats upper bed below 14 slats lower bed max. height of mattress 17 cm Metal anthracite |
| | | | 90 200 |



Wir empfehlen Matratze Novo, siehe Seite 14.16 – 14.17
 Nous recommandons le matelas Novo, voir page 14.16 – 14.17
 We recommend mattress Novo, see page 14.16 – 14.17

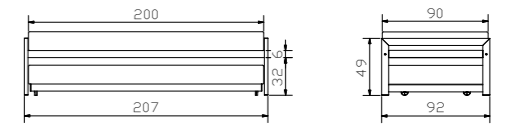



Fronten in Buche massiv natur oder weiss deckend, lackiert | Les parties façades en hêtre massif naturel ou blanc couvrant, laqué | Front parts in solid beech natural or white covering, lacquered

Bettrahmen in Schichtholz mit Folie Buche natur oder weiss ummantelt | Cadre de lit en bois laminé hêtre naturel ou blanc | Bedframe in plywood laminated natural beech or white

Ausführungen | Exécutions | Executions



06 Buche natur lackiert
Hêtre naturel laqué
Natural beech lacquered



10 Buche weiss deckend, lackiert
Hêtre blanc couvrant, laqué
Beech white covered, lacquered



Wir empfehlen Matratze Novo, siehe Seite 14.16 – 14.17
Nous recommandons le matelas Novo, voir page 14.16 – 14.17
We recommend mattress Novo, see page 14.16 – 14.1

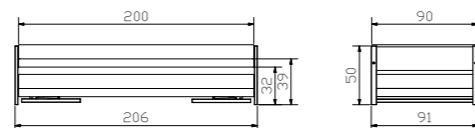

Weitere Beimebel siehe Register 2 | Autres accessoires voir registre 2 | Further accessories see index 2



Lido

Aufklappbett, bestehend aus:
Ober-Bett + Unter-Bett
Breite
Länge
Mit integriertem Lattenrost:
Star U, 18 Latten
Flex K, 28 Latten
Max. Matratzenhöhe 17 cm

Lit gigogne, composé de:
lit du dessus + lit du dessous
Largeur
Longueur
Avec sommier intégré :
Star U, 18 lattes
Flex K, 28 lattes
Hauteur max. du matelas 17 cm

Bed to open, consists of:
upper bed + lower bed
Width
Length
With slats integrated:
Star U, 18 slats
Flex K, 28 slats
Max. height of mattress 17 cm

Dimension cm

90
200

1 Star U 2 Flex K



Lovara



Kommode, Buche natur

Commode, Hêtre naturel

Chest of drawers, Natural beech

90/40/75

Dupla



Nachttisch, Buche natur

Table de nuit, Hêtre naturel

Bedside table, Natural beech

48/40/35



| | | | | Dimension cm | |
|--------------|---|---|--|--------------|--|
| Amici | Stapelbett (inkl. Lattenrost) | Lit superposable (sommier inclus) | Stacking bed (with slats) | | |
| | Breite | Largeur | Width | 90 | |
| | Länge | Longueur | Length | 200 | |
| | Unterbett: Max. Matratzenhöhe 16 cm | Lit inférieur : Hauteur max. du matelas 16 cm | Lower bed: Max. height of mattress 16 cm | | |
| | Mit integriertem Lattenrost: Star U, 18 Latten | Avec sommier intégré: Star U, 18 lattes | With slats integrated: Star U, 18 slats | | |

Fronten in Buche natur massiv | Les parties façades en hêtre naturel massif | Front parts in solid natural beech
Bettrahmen in Schichtholz mit Folie Buche natur | Cadre de lit en bois laminé hêtre naturel | Bedframe in plywood laminated natural beech

| | | | | Dimension cm | |
|--------------|-------------------|----------------------|----------------------|--------------|--|
| Amici | Stapelbett | Lit superposable | Stacking bed | | |
| | Breite | Largeur | Width | 90 | |
| | Länge | Longueur | Length | 200 | |
| Trio | Nachttisch, weiss | Table de nuit, blanc | Bedside table, white | 45/49/55 | |

Fronten in Buche massiv weiss deckend, lackiert | Les parties façades en hêtre massif blanc couvrant, laqué | Front parts in solid beech white covering, lacquered
Bettrahmen in Schichtholz mit Folie weiss ummantelt | Cadre de lit en bois laminé blanc | Bedframe in plywood laminated white

Ausführungen | Exécutions | Executions



06 Buche natur lackiert
Hêtre naturel laqué
Natural beech lacquered

10 Buche weiss deckend, lackiert
Hêtre blanc couvrant, laqué
Beech white covered, lacquered



Weitere Beimöbel siehe Register 2 | Autres accessoires voir registre 2 | Further accessories see index 2

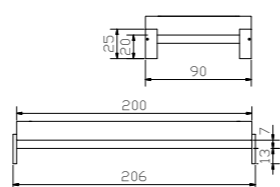

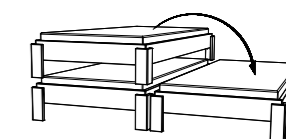

Wir empfehlen Matratze Novo, siehe Seite 14.16–14.17
Nous recommandons le matelas Novo, voir page 14.16–14.17
We recommend mattress Novo, see page 14.16–14.1

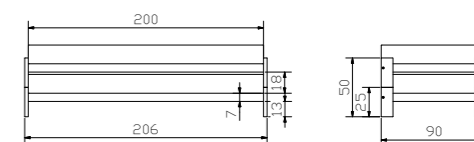

stapelbar | superposable | stackable





| | | | | Dimension cm | |
|--------------|---|---|--|--|----------|
| Amigo |  | Stapelbett (ohne Lattenrost) | Lit superposable (sans sommier) | Stacking bed (without slats) | |
| | | Breite | Largeur | Width | 90 |
| | | Länge | Longueur | Length | 200 |
| | | Unterbett: Freiraum für Lattenroste und Matratzen 26 cm | Lit inférieur: Espace libre pour sommiers et Matelas 26 cm | Lower bed: Free space for slats and mattresses 26 cm | |
| Dupla |  | Nachttisch | Table de nuit | Bedside table | 48/40/35 |

Alle Holzteile in Buche weiss lasiert, lackiert | Toutes les parties en bois en hêtre teinté blanc lasuré, laqué | All wooden parts in beech white stained, lacquered

Weitere Beimöbel siehe Register 2 | Autres accessoires voir registre 2 | Further accessories see index 2

Ausführungen | Exécutions | Executions



09
Buche weiss, lasiert, lackiert
Hêtre teinté blanc lasuré, laqué
Beech white stained, lacquered

80
Kernbuche natur geölt
Hêtre coeur rouge naturel huilé
Heart beech natural oiled

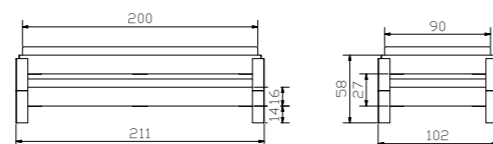

| | | | | Dimension cm | |
|--------------|---|------------|---------------|---------------|----------|
| Amigo |  | Einzelbett | Lit simple | Single bed | |
| | | Breite | Largeur | Width | 90 |
| | | Länge | Longueur | Length | 200 |
| Dupla |  | Nachttisch | Table de nuit | Bedside table | 48/40/35 |

Alle Holzteile in Kernbuche natur, geölt | Toutes les parties en bois en hêtre coeur rouge naturel, huilé | All wooden parts in heart beech natural, oiled

Weitere Beimöbel siehe Register 2 | Autres accessoires voir registre 2 | Further accessories see index 2

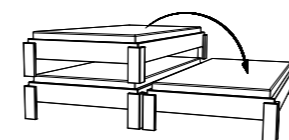

stapelbar | superposable | stackable

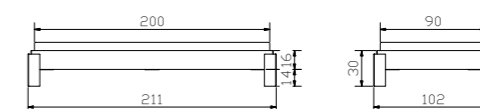





| | | | | Dimension cm | |
|---|---|---|---|--------------|--|
| Econom alu/chrom | Bett inkl. Kopf-/Fussbrett | Lit, panneau de tête/pied de lit incl. | Bed, head-/footboard included | | |
| | Breite | Largeur | Width | 90 | |
| | Länge | Longueur | Length | 200 | |
|  | Verbindungsbeschlag für 2 Betten (2er Set) verhindert das Auseinanderrutschen | Pièces de liaison pour 2 lits (Set de 2) évitent que les lits ne s'écartent l'un de l'autre | Connectors for two beds (Set of 2) prevents the parts from slipping apart | | |
| | Füsse auch in Komforthöhe 25 cm möglich | Pieds également livrables en hauteur confort 25 cm | Feet also available for a comfort level of 25 cm | | |

Bettrahmen in MDF mit Folie ummantelt | Cadre de lit en mdf laminé | Bedframe in mdf laminated

Kopf-/Fussteil Buche massiv | Tête/pied de lit en hêtre massif | Head-/footboard in solid beech

Weitere Beimöbel siehe Register 2 | Autres accessoires voir registre 2 | Further accessories see index 2

| | | | | Dimension cm | |
|-------------------|--|--|--|--------------|--|
| Econom alu | Bett, inkl. Kopf-/Fussbrett | Lit, panneau de tête/pied de lit incl. | Bed, head-/footboard included | | |
| | Breite | Largeur | Width | 90 | |
| | Länge | Longueur | Length | 200 | |
| | Höhe | Hauteur | Height | 20 | |
| | Mit integriertem Lattenrost: Star U, 18 Latten Flex K, 28 Latten | Avec sommier intégré : Star U, 18 lattes Flex K, 28 lattes | With lath grid integrated: Star U, 18 slats Flex K, 28 slats | | |
| Atrine |  Kommode | Commode | Chest of drawers | 90/49/85 | |
| Twia |  Nachttisch | Table de nuit | Bedside table | 45/49/40 | |

1 Star U
2 Flex K

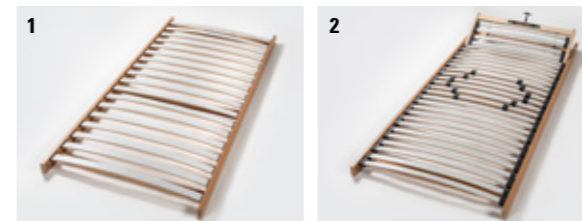

Ausführungen | Exécutions | Executions



06
Buche natur
lackiert
Hêtre naturel laqué
Natural beech
lacquered

10
Buche weiss deckend,
lackiert
Hêtre blanc couvrant,
laqué
Beech white covered,
lacquered

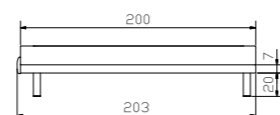
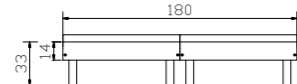
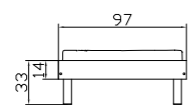

Elsa
Option Econom

Kopf-/Fussbrett
Tête/pied de lit
Head-/footboard



