



swiss bed concept



DREAM PRONTO

LIEFERUNG AB LAGER | LIVRAISON À PARTIR DU STOCK | DELIVERY FROM STOCK

Bei Bettbreite 160 und 180 cm Midtraver-move inklusive!

Pour une largeur de lit de 160 et 180 cm Midtraver-move inclus!
For bed width 160 and 180 cm Midtraver-move included!

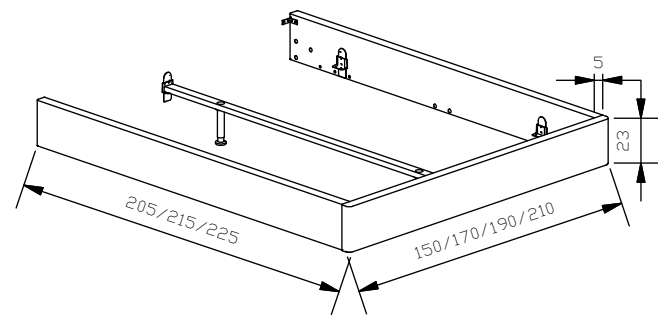
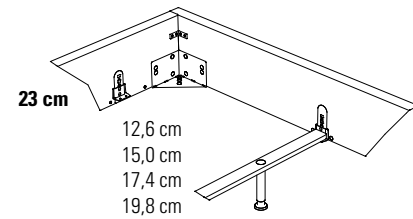

Bei allen Betten von Dream pronto ist die Einlegetiefe in vier verschiedenen Höhen standardmässig verstellbar.

Tous les lits Dream pronto ont une profondeur d'insertion réglable de 4 hauteurs différentes en standard.
All Dream pronto beds have an adjustable insertion depth of 4 different heights as standard.



Holzfüsse und Kopfteilblenden in den Holz Ausführungen:

Pieds en bois et panneaux de tête de lit dans les finitions en bois :
Wooden feet and headboard trims in the wood versions:

Holz | Bois | Wood



74 Eiche bright, geölt
Chêne bright, huilé
Oak bright, oiled



82 Nussbaum, geölt
Noyer, huilé
Walnut, oiled



87 Wildbuche natur, geölt
Hêtre nouveau naturel, huilé
Wildbeech natural, oiled

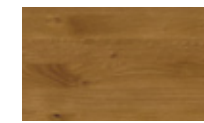

99 Wildeiche natur, geölt
Chêne nouveau naturel, huilé
Wildoak naturel, oiled

Stoffauswahl | Choix de tissus | Choice of fabrics

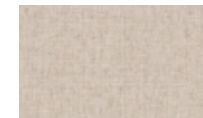

327 Pepe beige



335 Pepe grey

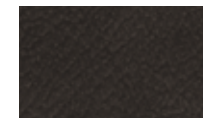

720 Buffalo shale



721 Buffalo grey



722 Buffalo espresso



770 Boucle ivory

Pepe kann chemisch gereinigt werden. Die abgebildeten Farben können von den Originalfarben und Strukturen abweichen.

Nous conseillons un nettoyage à sec pour le tissu Pepe. Les couleurs et les structures des illustrations peuvent être différentes des couleurs et des structures originales.

The fabric Pepe can be dry cleaned. The illustrated colours can be different than the original colours and structures.

LIEFERUNG

Livraison à partir du stock **AB LAGER**
Delivery from stock



*schnell,
zuverlässig,
ab Lager*

rapide, fiable, à partir du stock
quick, reliable, from stock

Mit unserem Schnellieferservice «PRONTO» können wir eine grosse Auswahl an Betten mit Beimöbeln und alle Modelle aus Edition Pronto (Register 4) und Dream pronto (Register 12) ab Lager liefern.

Die betreffenden Modelle sind in unserer Preisliste mit einem roten Punkt vor der Artikelnummer gekennzeichnet.

Notre service de livraison rapide « PRONTO » permet de livrer un large choix de lits et de meubles d'appoint et tous les modèles des éditions Pronto (registre 4) et Dream Pronto (registre 12) à partir du stock.

Les modèles concernés sont signalés par un point rouge devant le numéro d'article dans notre liste de prix.

With our quick delivery service «PRONTO» a huge selection of beds with side furniture and all models from Edition Pronto (index 4) and Dream Pronto (index 12) can be delivered from stock.

The respective models are marked in our pricelist with a red dot in front of the article number.



| Twia | Nachttisch | Table de nuit | Bedside table | Dimension cm |
|------|------------|---------------|---------------|--------------|
| | | | | 45/50/41 |

| Noah | Bett | Lit | Bed | Dimension cm |
|------|---------|----------|---------|---------------|
| | Breiten | Largeurs | Widths | 140, 160, 180 |
| | Länge | Longueur | Lengths | 200 |
| | Höhen | Hauteurs | Heights | 20, 25 |

Stoffauswahl | Choix de tissus | Choice of fabrics

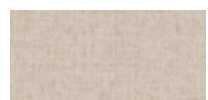

327 Pepe beige

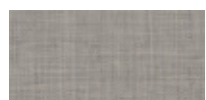

335 Pepe grey

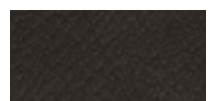

720 Buffalo shale

Holzauswahl | Choix de bois | Choice of wood



74 Eiche bright, geölt
Chêne bright, huilé
Oak bright, oiled

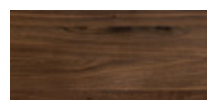

82 Nussbaum, geölt
Noyer, huilé
Walnut, oiled



87 Wildbuche, geölt
Hêtre sauvage, huilé
Wild beech, oiled



99 Wildeiche natur, geölt
Chêne sauvage naturel, huilé
Wild oak nature, oiled



Alle Polsterteile in Buffalo shale 720 | Toutes les parties rembourrées en Buffalo shale 720 | All upholstery parts in Buffalo shale 720

Alle Holzteile in Nussbaum, geölt | Toutes les parties en bois en noyer huilé | All wooden parts in walnut oiled

Twia: Korpus anthracit | Caisson anthracite | Body anthracite

Weitere Beimöbel siehe Register 2 | Autres accessoires voir registre 2 | Further accessories see index 2

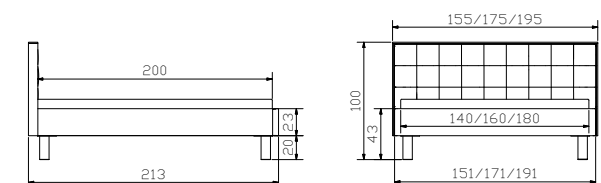



| | | | | Dimension cm |
|-------|------------|---------------|---------------|--------------|
| Stand | Nachttisch | Table de nuit | Bedside table | 48/38/42 |

| Selena | Bett | Lit | Bed | Dimension cm |
|--------|---------|----------|--------|---------------|
| | Breiten | Largeurs | Widths | 140, 160, 180 |
| | Länge | Longueur | Length | 200 |
| | Höhe | Hauteur | Height | 20 |

Stoffauswahl | Choix de tissus | Choice of fabrics



770 Boucle ivory

Holzauswahl | Choix de bois | Choice of wood



74 Eiche bright, geölt
Chêne bright, huilé
Oak bright, oiled

Alle Polsterteile in Boucle ivory 770 | Toutes les parties rembourrées en Boucle ivory 770 | All upholstery parts in Boucle ivory 770

Alle Holzteile in Eiche bright, geölt | Toutes les parties en bois en chêne bright, huilé | All wooden parts in oak bright, oiled

Weitere Beimöbel siehe Register 2 | Autres accessoires voir registre 2 | Further accessories see index 2

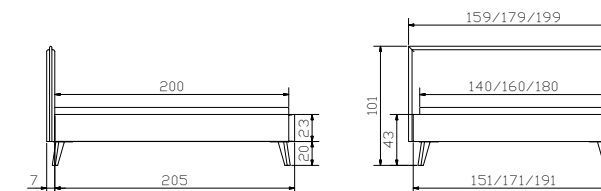



| | | | | |
|--------------------------|------------|---------------|---------------|--------------------------------|
| Nali anthracit | Nachttisch | Table de nuit | Bedside table | Dimension cm Ø 48/52 |
|--------------------------|------------|---------------|---------------|--------------------------------|

| | | | | |
|--------------|----------------------------------|--|-----------------------------------|---|
| Marla | Bett Breiten Länge Höhe | Lit Largeurs Longueur Hauteur | Bed Widths Length Height | Dimension cm 140, 160, 180 200 20 |
|--------------|----------------------------------|--|-----------------------------------|---|

Stoffauswahl | Choix de tissus | Choice of fabrics



770 Boucle ivory

Alle Polsterteile in Boucle ivory 770 | Toutes les parties rembourrées en Boucle ivory 770 | All upholstery parts in Boucle ivory 770

Holzteile in Eiche bianco, geölt | Parties en bois en chêne bianco, huilé | Wooden parts in oak bianco, oiled

Alle Metallteile in anthracit | Toutes les parties en métal en anthracite | All metal parts in anthracite

Weitere Beimöbel siehe Register 2 | Autres accessoires voir registre 2 | Further accessories see index 2

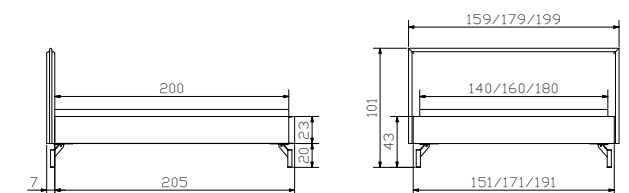



| | | | | |
|--------------------------|------------|---------------|---------------|--------------------------------|
| Nali anthracit | Nachttisch | Table de nuit | Bedside table | Dimension cm Ø 48/52 |
|--------------------------|------------|---------------|---------------|--------------------------------|

| | | | | |
|--------------|----------------------------------|--|-----------------------------------|---|
| Nardo | Bett Breiten Länge Höhe | Lit Largeurs Longueur Hauteur | Bed Widths Length Height | Dimension cm 140, 160, 180 200 20 |
|--------------|----------------------------------|--|-----------------------------------|---|

Stoffauswahl | Choix de tissus | Choice of fabrics

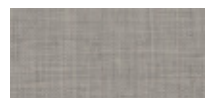

335 Pepe grey

Alle Polsterteile in Pepe grey 335 | Toutes les parties rembourrées en Pepe grey 335 | All upholstery parts in Pepe grey 335
Alle Holzteile in Eiche bianco, geölt | Toutes les parties en bois en chêne bianco, huilé | All wooden parts in oak bianco, oiled
Alle Metallteile in anthracit | Toutes les parties en métal en anthracite | All metal parts in anthracite
Weitere Beimöbel siehe Register 2 | Autres accessoires voir registre 2 | Further accessories see index 2

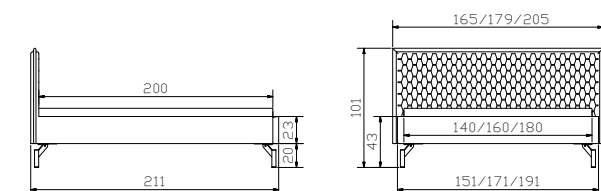



| | | | | |
|-------------|------------|---------------|---------------|---------------------|
| Nali | Nachttisch | Table de nuit | Bedside table | Dimension cm |
| anthracit | | | | ∅ 48/52 |

| | | | | |
|-------------|---------|----------|--------|---------------------|
| Nora | Bett | Lit | Bed | Dimension cm |
| | Breiten | Largeurs | Widths | 140, 160, 180 |
| | Länge | Longueur | Length | 200 |
| | Höhe | Hauteur | Height | 20 |

Stoffauswahl | Choix de tissus | Choice of fabrics



770 Boucle ivory

Alle Polsterteile in Boucle ivory 770 | Toutes les parties rembourrées en Boucle ivory 770 | All upholstery parts in Boucle ivory 770

Alle Holzteile in Eiche bianco, geölt | Toutes les parties en bois en chêne bianco, huilé | All wooden parts in oak bianco, oiled

Alle Metallteile in anthracit | Toutes les parties en métal en anthracite | All metal parts in anthracite

Weitere Beimöbel siehe Register 2 | Autres accessoires voir registre 2 | Further accessories see index 2

12.90

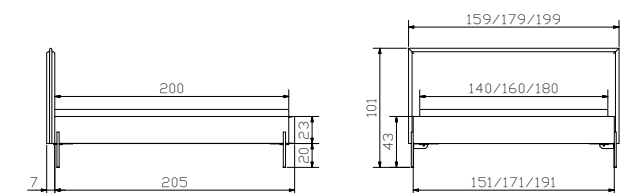

12.91



| | | | | Dimension cm |
|---------------|------------|---------------|------------------|--------------|
| Surf | Nachttisch | Table de nuit | Bedside table | 48/38/36 |
| Quatro | Kommode | Commode | Chest of drawers | 45/50/86 |

| Stefano | Bett | Lit | Bed | Dimension cm |
|----------------|---------|----------|---------|---------------|
| | Breiten | Largeurs | Widths | 140, 160, 180 |
| | Länge | Longueur | Length | 200 |
| | Höhen | Hauteurs | Heights | 20, 25 |

Stoffauswahl | Choix de tissus | Choice of fabrics

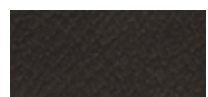

720 Buffalo shale



721 Buffalo grey



722 Buffalo espresso

Alle Polsterteile in Buffalo shale 720 | Toutes les parties rembourrées en Buffalo shale 720 | All upholstery parts in Buffalo shale 720

Holzteile in Wildeiche natur, geölt | Parties en bois en chêne nouveau naturel, huilé | Wooden parts in wildoak natural, oiled

Alle Metallteile in anthracit | Toutes les parties en métal en anthracite | All metal parts in anthracite

Quatro: Korpus anthracith | Caisson anthracite | Body anthracite

Weitere Beimöbel siehe Register 2 | Autres accessoires voir registre 2 | Further accessories see index 2

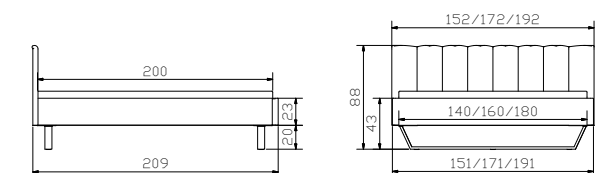



Dimension cm

| | | | | |
|-------------|------------|---------------|---------------|----------|
| Dowe | Nachttisch | Table de nuit | Bedside table | 45/50/55 |
|-------------|------------|---------------|---------------|----------|

Dimension cm

| | | | | |
|--------------|---------|----------|---------|---------------|
| Noemi | Bett | Lit | Bed | |
| | Breiten | Largeurs | Widths | 140, 160, 180 |
| | Länge | Longueur | Length | 200 |
| | Höhen | Hauteurs | Heights | 20, 25 |

Stoffauswahl | Choix de tissus | Choice of fabrics

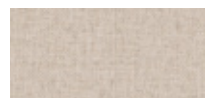

327 Pepe beige

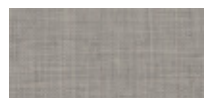

335 Pepe grey

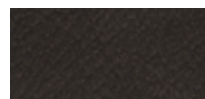

720 Buffalo shale

Holzauswahl | Choix de bois | Choice of wood



74 Eiche bright, geölt
Chêne bright, huilé
Oak bright, oiled



82 Nussbaum, geölt
Noyer, huilé
Walnut, oiled



87 Wildbuche, geölt
Hêtre sauvage, huilé
Wild beech, oiled



99 Wildeiche natur, geölt
Chêne sauvage naturel, huilé
Wild oak nature, oiled



Alle Polsterteile in Pepe beige 327 | Toutes les parties rembourrées en Pepe beige 327 | All upholstery parts in Pepe beige 327

Alle Holzteile in Eiche bright, geölt | Toutes les parties en bois en chêne bright huilé | All wooden parts in oak bright oiled

Dowe: Korpus weiss | Caisson blanc | Body white

Weitere Beimöbel siehe Register 2 | Autres accessoires voir registre 2 | Further accessories see index 2

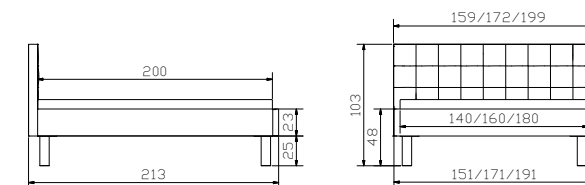



| | Nachttisch | Table de nuit | Bedside table | Dimension cm |
|-----------------|---|---|---|--------------|
| Circo 52 | Leselampe (2er Set) 12V DC, 6 LED 3 Beleuchtungsarten | Lampe de lecture (Set de 2) 12V DC, 6 LED 3 différentes illuminations | Reading lamp (Set of 2) 12V DC, 6 LED 3 different illuminations | Ø 42/52 |

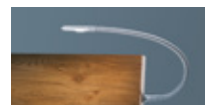

| | Bett | Lit | Bed | Dimension cm |
|---------------|---------------------------|----------------------------------|-----------------------------|--------------------------------|
| Tamara | Breiten Länge Höhen | Largeurs Longueur Hauteurs | Widths Length Heights | 140, 160, 180 200 20, 25 |

Stoffauswahl | Choix de tissus | Choice of fabrics

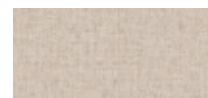

327 Pepe beige

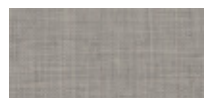

335 Pepe grey

Holz Auswahl | Choix de bois | Choice of wood



74 Eiche bright, geölt
Chêne bright, huilé
Oak bright, oiled



82 Nussbaum, geölt
Noyer, huilé
Walnut, oiled



87 Wildbuche, geölt
Hêtre sauvage, huilé
Wild beech, oiled



Alle Polsterteile in Pepe grey 335 | Toutes les parties rembourrées en Pepe grey 335 | All upholstery parts in Pepe grey 335

Füße in Eiche bright, geölt und Nachttisch in Eiche bianco, gebürstet, geölt | Pieds en chêne bright, huilé et table de nuit en bois en chêne bianco, brossé, huilé | Feet in oak bright, oiled and bedside table in oak bianco, brushed, oiled

Leselampen und weitere Beimöbel siehe Register 2 | Lampes de lecture et autres accessoires voir registre 2 | Reading lamps and further accessories see index 2

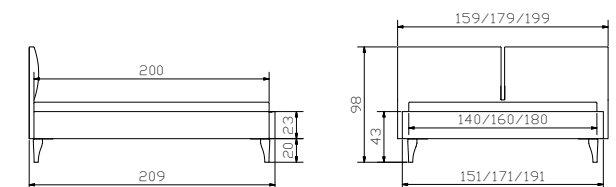



Dimension cm

| | | | | |
|-----------------------|-------------------|-------------------------|----------------------|-----------|
| Pato anthracit | Bank inkl. Kissen | Banquette, Coussin incl | Bench, Cushion incl. | 144/44/38 |
| Nali anthracit | Nachttisch | Table de nuit | Bedside table | ∅ 48/52 |

Dimension cm

| | | | | |
|---------------|---------|----------|--------|---------------|
| Gloria | Rahmen | Cadre | Frame | |
| | Breiten | Largeurs | Widths | 140, 160, 180 |
| | Länge | Longueur | Length | 200 |
| | Höhe | Hauteur | Height | 20 |

Stoffauswahl | Choix de tissus | Choice of fabrics

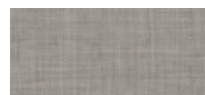

335 Pepe grey

Alle Polsterteile in Pepe grey 335 | Toutes les parties rembourrées en Pepe grey 335 | All upholstery parts in Pepe grey 335
Alle Holzteile in Eiche bianco, geölt | Toutes les parties en bois en chêne bianco, huilé | All wooden parts in oak bianco, oiled
Alle Metallteile in anthracit | Toutes les parties en métal en anthracite | All metal parts in anthracite
Weitere Beimöbel siehe Register 2 | Autres accessoires voir registre 2 | Further accessories see index 2

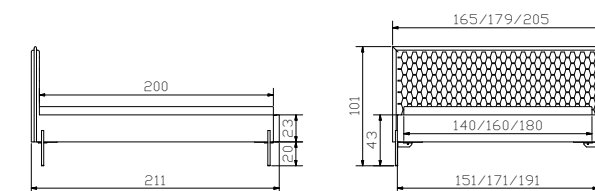



| | | | | Dimension cm |
|-------------|------------|---------------|---------------|--------------|
| Aska | Sekretär | Secrétaire | Bureau | 120/60/85 |
| Styl | Nachttisch | Table de nuit | Bedside table | 43/43/48 |

| | | | | Dimension cm |
|----------------|---------|----------|--------|---------------|
| Silento | Rahmen | Cadre | Frame | |
| | Breiten | Largeurs | Widths | 140, 160, 180 |
| | Länge | Longueur | Length | 200 |
| | Höhe | Hauteur | Height | 20 |

Stoffauswahl | Choix de tissus | Choice of fabrics

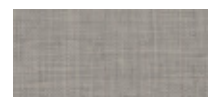

335 Pepe grey

Holzauswahl | Choix de bois | Choice of wood



74 Eiche bright, geölt
Chêne bright, huilé
Oak bright, oiled



82 Nussbaum, geölt
Noyer, huilé
Walnut, oiled



Alle Polsterteile in Pepe grey 335 | Toutes les parties rembourrées en Pepe grey 335 | All upholstery parts in Pepe grey 335

Alle Holzteile in Eiche bright, geölt ausser Aska in Eiche bianco, gebürstet, geölt
Toutes les parties en bois en chêne bright, huilé sauf Aska en chêne bianco, brossé, huilé
All wooden parts in oak bright, oiled except Aska in oak bianco, brushed, oiled

Beimöbel siehe Register 2 | Autres accessoires voir registre 2 | Further accessories see index 2

