

Füsse | Pieds | Feet

Roll-Box 20/25



Bettkasten in weiss oder anthrazit (Boden weiss)

Voraussetzung

Bettfusshöhe von mindestens 20 cm erforderlich

Optionen

Deckel Covero in weiss, Stoffabdeckung Saceto in Polyester grau.

Roll-Box 20/25 + Covero



Tiroir de lit en blanc ou anthracite (fond blanc)

Condition préalable

Une hauteur de pieds de lit d'au moins 20 cm est nécessaire

Options

Couvercle Covero en blanc, tissu de protection Saceto en polyester gris.

Roll-Box 20/25 + Saceto



Bed drawer in white or anthracite (bottom white)

Condition

Feet of bed need a minimum height of 20 cm

Options

Cover Covero in white, tissue of protection Saceto in polyester grey.



Roll-Box 20

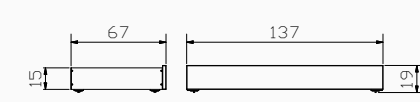

Roll-Box 25

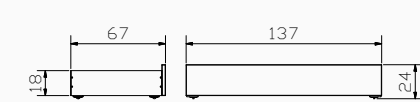

Stauraum | Espace de rangement | Storage space

Roll-Box 20	=	134 × 61 × 13 cm
Roll-Box 25	=	134 × 61 × 16 cm

Ausführungen der Roll-Box-Fronten | Exécutions des façades des Roll-Box | Executions of the Roll-Box fronts

Holz massiv | Bois massif | Solid wood

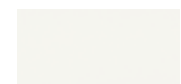

10 Buche weiss deckend, lackiert
Hêtre blanc couvrant, laqué
Beech white covered, lacquered



16 Buche anthracit deckend, lackiert
Hêtre anthracite couvrant, laqué
Beech anthracit covered, lacquered



71 Eiche bianco, geölt
Chêne bianco, huilé
Oak bianco, oiled



73 Eiche bianco, gebürstet, geölt
Chêne bianco, brossé, huilé
Oak bianco, brushed, oiled



74 Eiche bright, geölt
Chêne bright, huilé
Oak bright, oiled



80 Kernbuche natur, geölt
Hêtre coeur rouge naturel, huilé
Heart beech natural, oiled



86 Eiche natur, gebürstet, geölt
Chêne naturel, brossé, huilé
Oak natural, brushed, oiled



91 Eiche cognac, gebürstet, geölt
Chêne cognac, brossé, huilé
Oak cognac, brushed, oiled



93 Wildeiche natur, gebürstet, geölt
Chêne nouveau naturel, brossé, huilé
Wildoak natural, brushed, oiled



Stoff- und Lederauswahl | Choix de tissus et cuirs | Choice of fabrics and leathers

3. Preiskategorie | 3^e catégorie de prix | 3rd price range

Kitana 600–604, 100% Polyester



600 beige



601 nougat



602 grigio



603 aqua



604 anthrazit

Ranch 660–664, 100% Baumwolle | Coton | Cotton



660 stone



661 grit



662 jeans



663 indigo



664 hunter

Bei der Stoffausführung Ranch wird in der Produktion mittels Waschung ein charakteristischer Vintage-Look erzielt.

Lors de la production par le biais de différents lavages, un look vintage caractéristique est donné au tissu Ranch.

In the Ranch fabric version, a characteristic vintage look is achieved in production by way of washing.

Rinovo 700–701, 100% Polyester recycelt | recyclé | recycled



700 anthracit



701 taupe



640 chiaro



641 anthracit

Ritorno 640–641, 100% Polyester recycelt | recyclé | recycled

Velluto 740–742, Oberfläche | Surface: 100% Polyester Basis | Base: 90% Polyester, 10% Baumwolle | Coton | Cotton



740 grey



741 ivory



742 coffee

4. Preiskategorie | 4^e catégorie de prix | 4th price range

Real* 505–516, EchtLeder | Cuir véritable | Real leather

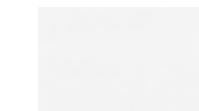

505 bianco



506 ecru



507 creta



508 moro



509 ardesia



513 falda



514 cenere



515 panna



516 notte

Alpina, Boucle, Boston, Buffalo, Capo, Cyclo, Fusio, Kitana, Ranch, Rinovo, Ritorno, Tocco und Velluto können chemisch gereinigt werden. Die abgebildeten Farben können von den Originalfarben und Strukturen abweichen.

*Narben, Farb- und Strukturdifferenzen sowie Faltenbildung sind Natureigenschaften von echtem Leder. Leder enthält nichttextile Teile tierischen Ursprungs.

Nous conseillons un nettoyage à sec pour les matières Alpina, Boucle, Boston, Buffalo, Capo, Cyclo, Fusio, Kitana, Ranch, Rinovo, Ritorno, Tocco et Velluto. Les couleurs et les structures des illustrations peuvent être différentes des couleurs et des structures originales.

*Les cicatrices, les différences de teinte et de structure ainsi que la formation de plis sont des marques naturelles du cuir véritable. Le cuir contient des éléments non textiles d'origine animale.

The covers Alpina, Boucle, Boston, Buffalo, Capo, Cyclo, Fusio, Kitana, Ranch, Rinovo, Ritorno, Tocco and Velluto can be dry cleaned. The pictured colours can be different than the original colours and structure

*Any marks, differences of colour or structure or wrinkle formations are natural characteristics of real leather. Leather includes non-textile parts of animal origin.

3. Preiskategorie | 3^e catégorie de prix | 3rd price range

Alpina 390–394, 100% Polyester



390 lightgrey 391 anthrazit 392 red 393 navy 394 smoke

Boucle 770–773, 100% Polyester



770 ivory 771 grey 772 fresco 773 mouse

Boston 650–654, Oberfläche | Surface: 100% Polyester, Basis | Base: 70% Polyester, 30% Baumwolle | Coton | Cotton



650 clay 651 bean 652 mocca 653 turtle 654 tizo

Tocco 710–712, 100% Polyester

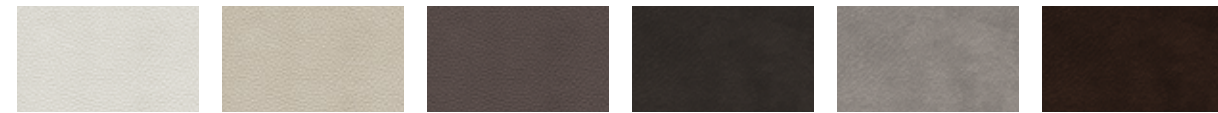

710 white 711 creme 712 chocolate 720 shale 721 grey 722 espresso

Campos 372–376, Kunstleder | Cuir synthétique | Synthetic leather

Oberfläche | Surface: 100% Polyurethan | Polyurethane, Basis | Base: 71% Polyester, 29% Baumwolle | Coton | Cotton

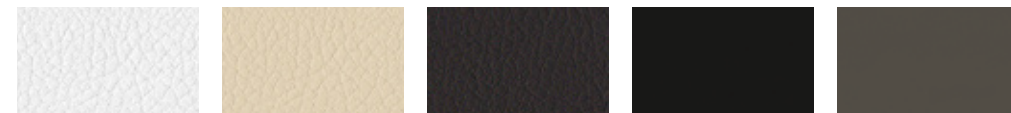

372 blanc 373 creme 374 cafe 375 nero 376 kit

Capo 760–765, 100% Polyester



760 anthracit 761 grey 762 rose 763 linen 764 light brown 765 taupe

Casual 330–334, Kunstleder | Cuir synthétique | Synthetic leather

Oberfläche | Surface: 100% Polyurethan | Polyurethane, Basis | Base: 60% Polyester, 40% Baumwolle | Coton | Cotton

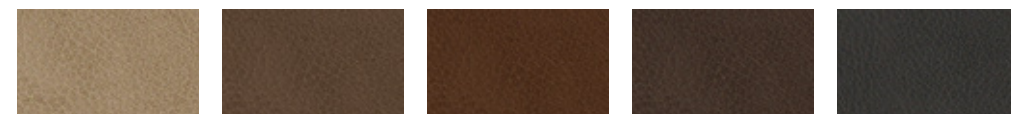

330 sahara 331 cannelle 332 cognac 333 olive 334 carbon

Cyclo 730–731, 100% Polyester



730 cream 731 macciato

Fusio 750–752, 100% Polyester



750 shell 751 anthracit 752musk

selezione

01

MODELLAUSWAHL

Sélection du modèle | Model selection

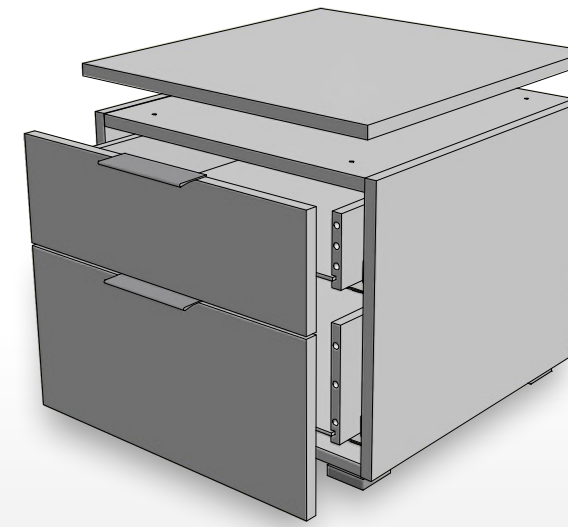

Stellen Sie sich Ihr Wunsch-Beimöbel nach Ihrem Geschmack zusammen: Der Korpus (Abb. 02), in zwei verschiedenen Farbvarianten, lässt sich zu den Front- und Top-Covern (Abb. 03) in acht Holz- und Farbausführungen kombinieren. Die Beimöbel können zerlegt oder teilmontiert bestellt werden. Bei zusammengesetzten Möbeln (z. B. Qunito, Incentro, ...) muss der Deckel noch montiert werden. Bei Kommoden mit Türen ist jeweils ein Einlegeboden vorhanden, Türöffnung nach links oder rechts möglich. Zusätzliche Böden sind erhältlich.

Composez le meuble d'appoint de vos rêves selon vos goûts : Le caisson (ill. 02), disponible en 2 variantes de couleurs, peut être combiné avec les façades et couvercles supérieurs (ill. 03) en 8 finitions de bois et de coloris. Les meubles d'appoint peuvent être commandés en kits ou assemblés. Pour les meubles assemblés (p. ex. Qunito, Incentro, ...) le couvercle doit encore être fixé. Les commodes avec portes sont équipées d'une étagère, ouverture de la porte possible à gauche ou à droite. Si besoin, des étagères supplémentaires sont disponibles.

Put together the side furniture you want according to your own taste: The body (fig. 02), in two different colour versions, can be combined with the front and top covers (fig. 03) in eight wood and colour versions. The furniture can be ordered disassembled or assembled. For assembled furniture (e.g. Qunito, Incentro, ...) the top cover must still be fitted. Chests of drawers with doors have one shelf, door opening possible to the left or right. Additional shelves are available.



Kombinationsbeispiele und techn. Informationen
Exemples et informations
Examples and informations



02

KORPUS

Caisson | Body



10 Weiss | Blanc | White



16 Anthracit | Anthracite



FÜSSE

Pieds | Feet

STANDARD



OPTION

Leg 8 cm



alu

Jone 10 cm



anthracit used

Cila 10 cm



anthracit



The mark of responsible forestry
FSC® C122646
Look for FSC® certified products



03

TOP/FRONT

Farben | Couleurs | Colours



10 Weiss | Blanc | White



16 Anthracit | Anthracite



04

GRIFFE

Poignées | Handles

STANDARD



Alu

Griff zu Folienfronten
Poignée pour façades en mélaminé
Handle for foil fronts

STANDARD



Holzgriff zu Holzfronten
Poignée en bois pour façades en bois
Wooden handle for wooden fronts

OPTION

Rivo



Used

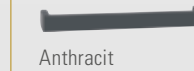

Anthracit

Metallgriff zu Holzfronten

Poignée en métal pour façades en bois
Metal handle for wooden fronts