



swiss bed concept



DREAM LINE

POLSTERBETTEN | LITS REMBOURRÉS | UPHOLSTERED BEDS

Bettrahmen | Cadres de lit | Bedframes

2-seitig | 2 faces | 2-sided

Lungo 23/2S

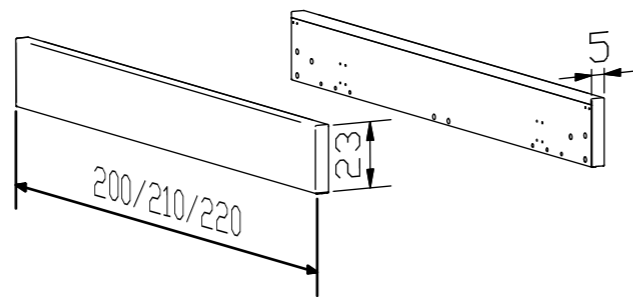

Lungo 28/2S

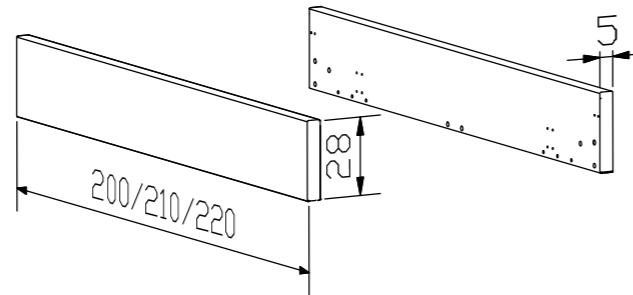

Alle Bettrahmen | Tous les cadres de lit | All bedframes
Längen | Longueurs | Lengths: 200, 210, 220 cm

Stoffvielfalt siehe Seiten 12.16–12.17
 Large choix de tissus voir pages 12.16–12.17
 Large diversity of fabrics see pages 12.16–12.17

Bei allen Bettrahmen Lungo und Ciara ist die Einlegetiefe in 4 verschiedenen Höhen standardmässig verstellbar.
Midtraver-move bei allen Bettrahmen Lungo und Ciara ab der Breite 160 cm inklusive.

Tous les cadres de lit Lungo et Ciara ont une profondeur d'insertion réglable de 4 hauteurs différentes en standard.
 La Midtraver-move est incluse avec tous les cadres de lit Lungo et Ciara à partir de 160 cm de largeur.

All Lungo and Ciara bed frames have an adjustable insertion depth of 4 different heights as standard.
 Midtraver-move is included with all Lungo and Ciara bed frames from 160 cm width.

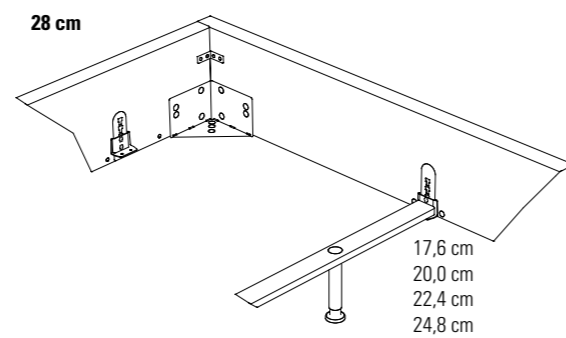
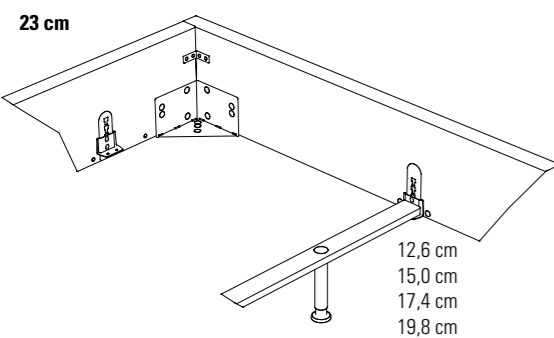

Kopf-/Fussteil-Set | Set têtes et pieds de lit | Set head-/footboards

Combia

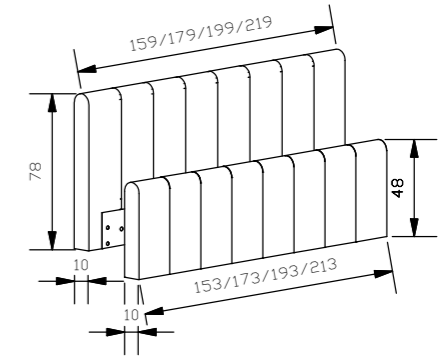

Ronio

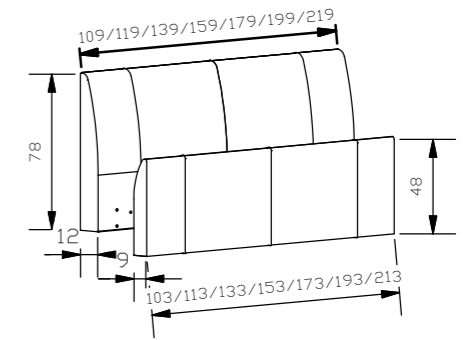

Venus

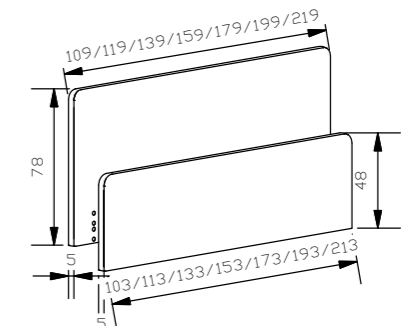

Combia

Breiten | Largeurs | Widths: 140, 160, 180, 200 cm

Ronio, Venus

Breiten | Largeurs | Widths: 90, 100, 120, 140, 160, 180, 200 cm

Combio



Adapter zur Befestigung der Leselampen an Kopfteilen | Adaptateur pour la fixation des lampes de lecture aux têtes de lit | Adapter to assemble the reading lamps to the headboards

Bettrahmen | Cadres de lit | Bedframes

3-seitig | 3 faces | 3-sided

Moon 18/3S

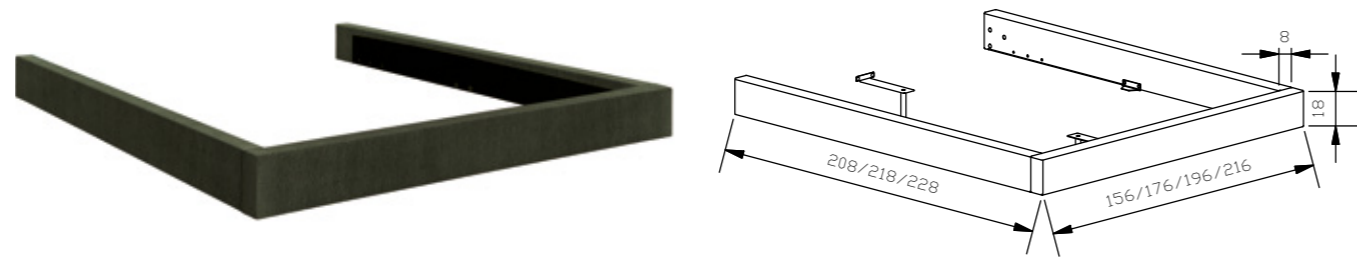

Sole 18/3S

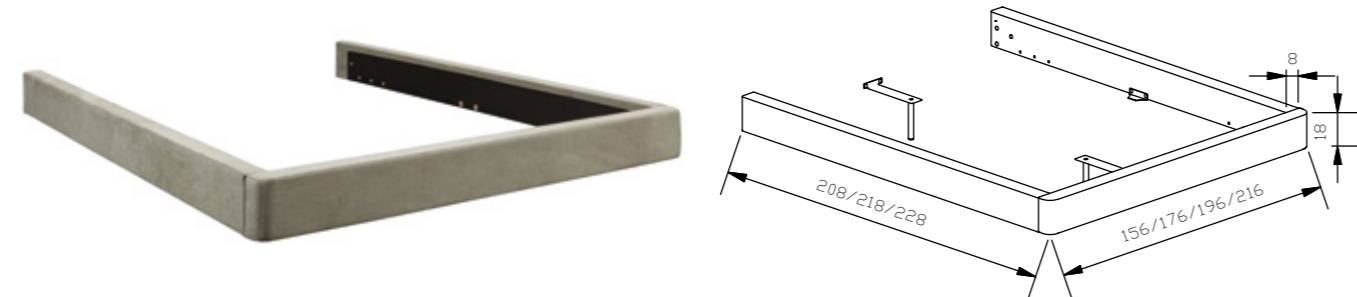

Traversen | Traverses | Bars

Wir empfehlen grundsätzlich den Einsatz von Crosstraver (Quertraverse) oder Midtraver (Längstraverse).

Nous recommandons en général l'utilisation de Crosstraver (traverse transversale) ou Midtraver (traverse centrale).

We recommend basically the insertion of Crosstraver (central cross bar) or Midtraver (central bar).

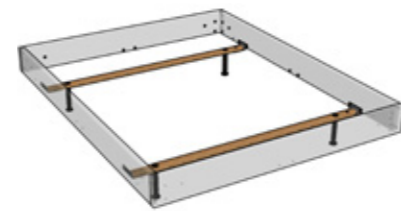
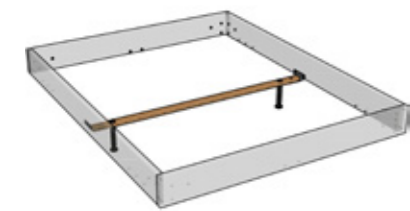

Crosstraver

Quertraverse | Traverse transversale | Central cross bar

Für alle Bettbreiten | Pour toutes les largeurs de lit | For all bed widths

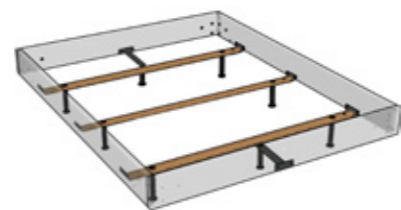
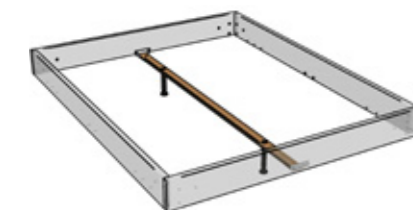

Crosstraver-Twin

Quertraversen | Traverses transversales | Cross bars

Für alle Bettbreiten | Pour toutes les largeurs de lit | For all bed widths

Crosstraver-XXL

Quertraversen | Traverses transversales | Cross bars

Für alle Bettbreiten | Pour toutes les largeurs de lit | For all bed widths

Midtraver

Längstraverse | Traverse centrale | Central bar

Für Betten ab Breite 140 cm mit 2 Lattenrosten oder Motorrahmen-einbau | Pour les lits à partir de 140 cm de largeur avec 2 sommiers ou l'installation d'un cadre motorisé | For beds from 140 cm width with 2 slats or motor frame installation

Übersicht Kompatibilität Traversen siehe Seite 2.12 | Aperçu compatibilité traverses voir page 2.12 | Overview compatibility bars see page 2.12

Bettrahmen | Cadres de lit | Bedframes

3-seitig | 3 faces | 3-sided

Ab 160 cm Midtraver-move inklusive siehe Seite 12.4

A partir de 160 cm Midtraver-move incluse voir page 12.4

From 160 cm Midtraver-move included see page 12.4

Lungo 23/3S

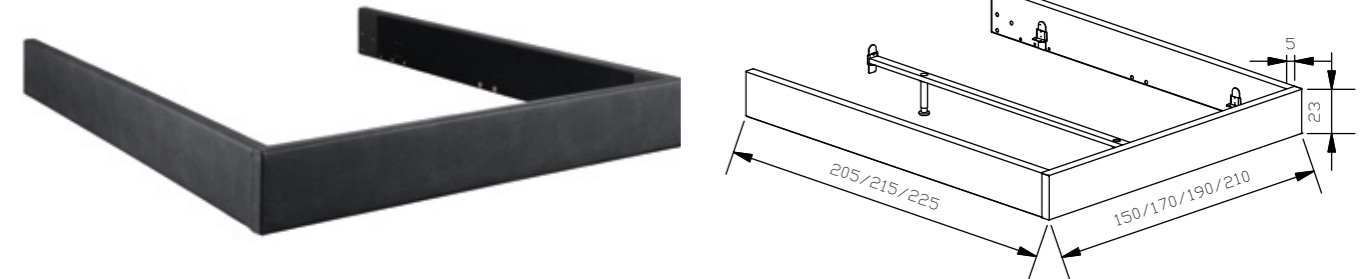

Lungo 28/3S

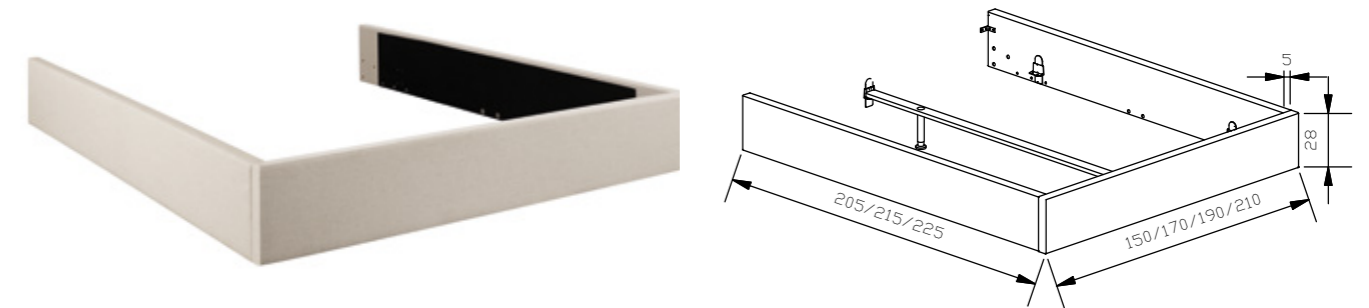

Ciara 23/3S

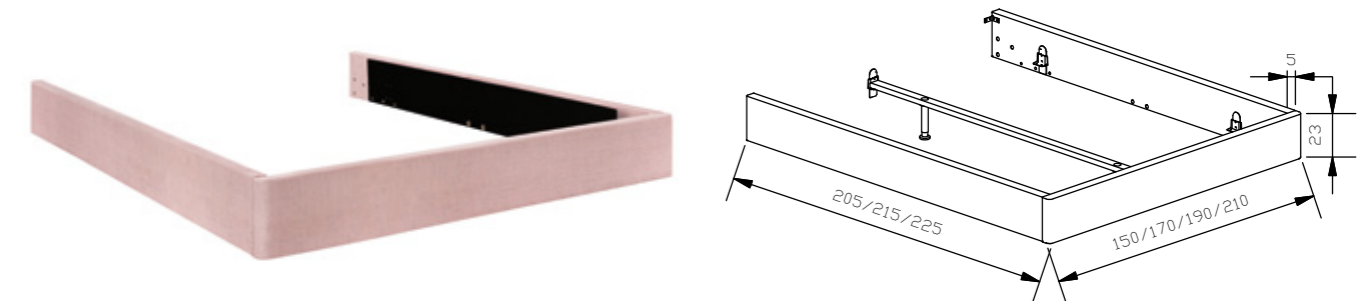

Ciara 28/3S

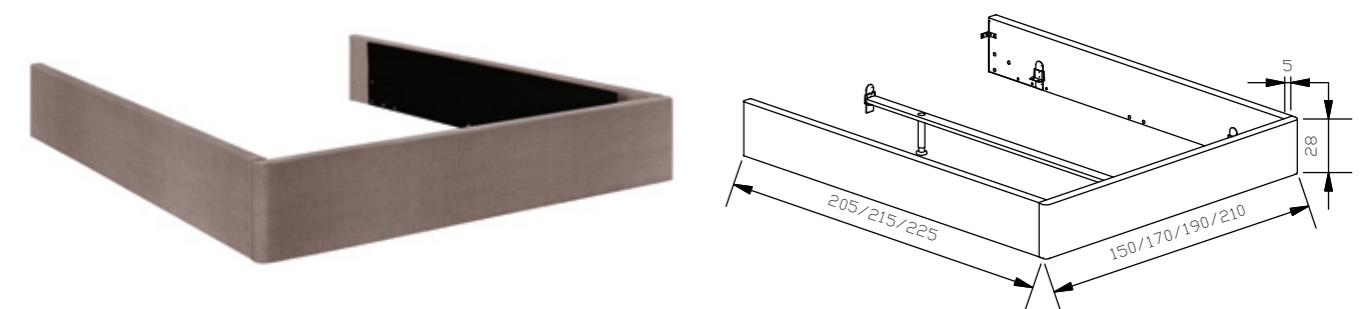

Alle Bettrahmen | Tous les cadres de lit | All bedframes

Breiten | Largeurs | Widths: 140, 160, 180, 200 cm

Längen | Longueurs | Lengths: 200, 210, 220 cm

Stoffvielfalt siehe Seiten 12.16–12.17

Large choix de tissus voir pages 12.16–12.17

Large diversity of fabrics see pages 12.16–12.17



Bei Echtleder mit sichtbarer Naht auf Fläche | Pour cuir véritable avec surpiqûre en surface | For real leather with visible stitching on surface

Kopfteile | Têtes de lit | Headboards

zu **Bettrahmen 3-seitig** | pour cadres de lit 3 faces | to bedframes 3-sided

gepolstert | rembourrées | upholstered

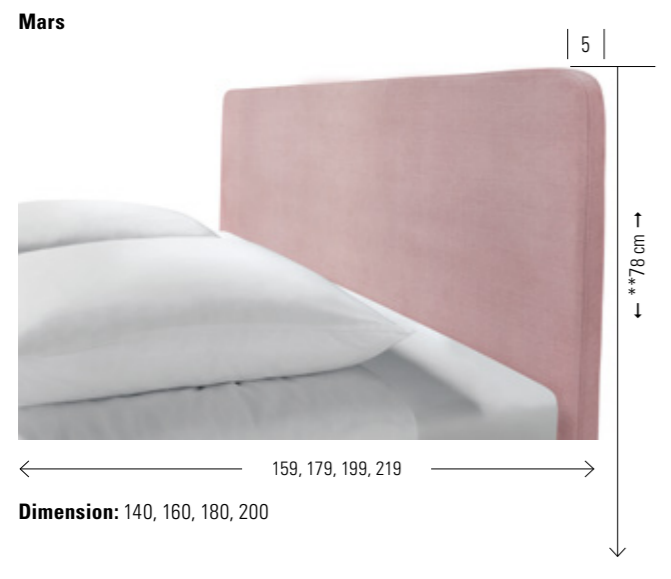
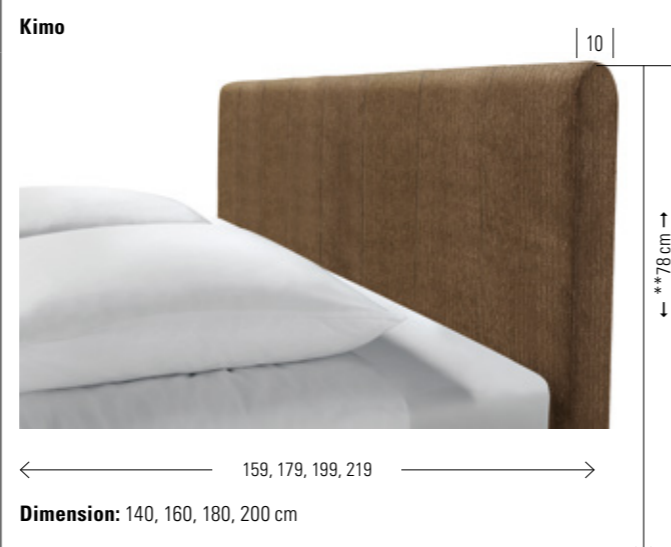
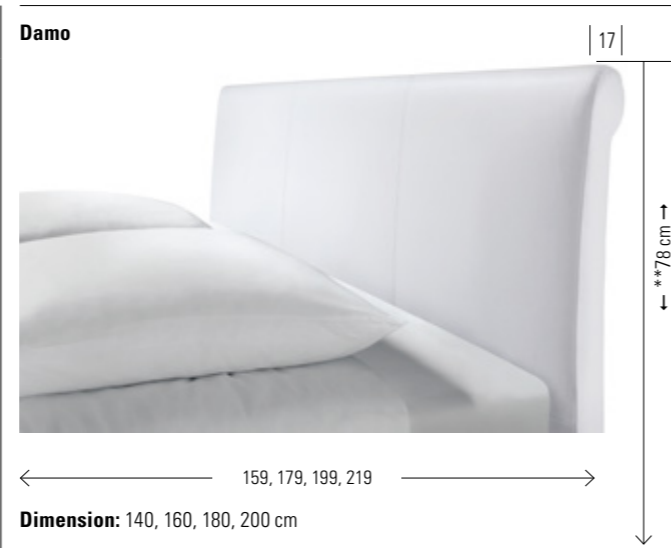
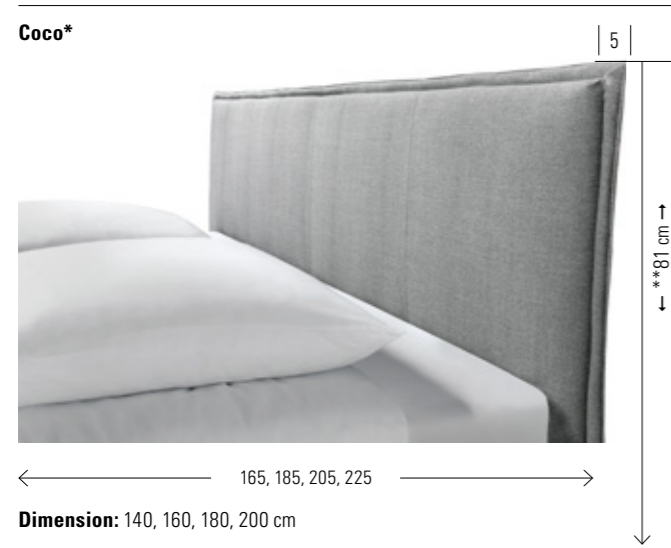

***Leselampen nicht montierbar**
Montage de lampes de lecture impossible
No possibility to assemble reading lamps

****Höhenmass Kopfteile ab Bettrahmen Unterkante**
Hauteur des têtes de lit à partir du cadre du lit bord inférieur
Height of headboards from bed frame bottom edge

Kopfteile | Têtes de lit | Headboards

zu **Bettrahmen 3-seitig** | pour cadres de lit 3 faces | to bedframes 3-sided

gepolstert | rembourrées | upholstered

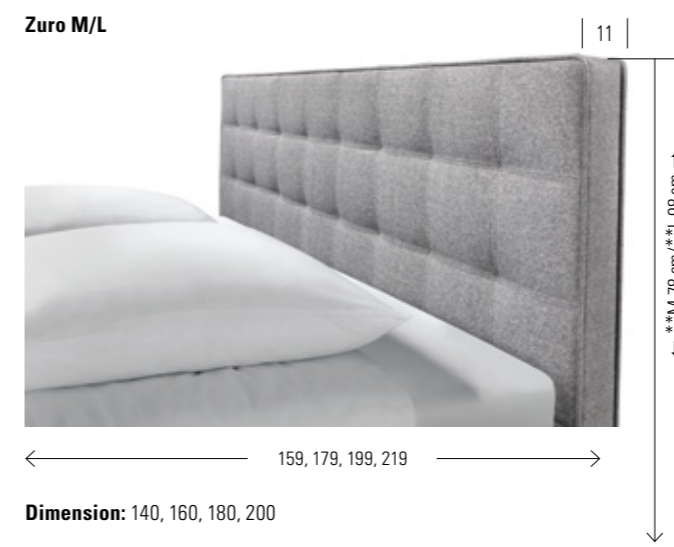
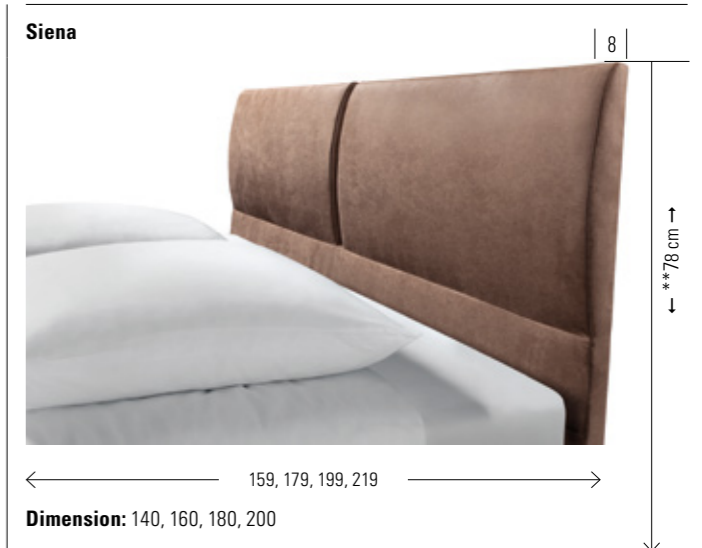

****Höhenmass Kopfteile ab Bettrahmen Unterkante**
Hauteur des têtes de lit à partir du cadre du lit bord inférieur
Height of headboards from bed frame bottom edge

Combino



Adapter zur Befestigung der Leselampen an Kopfteilen | Adaptateur pour la fixation des lampes de lecture aux têtes de lit | Adapter to assemble the reading lamps to the headboards

Damo, Kimo, Orion, Siena, Zuro

Leselampen siehe Register 2
Lampes de lecture voir registre 2
Reading lamps index 2

Bettrahmen | Cadres de lit | Bedframes

4-seitig | 4 faces | 4-sided

Moon 18/4S

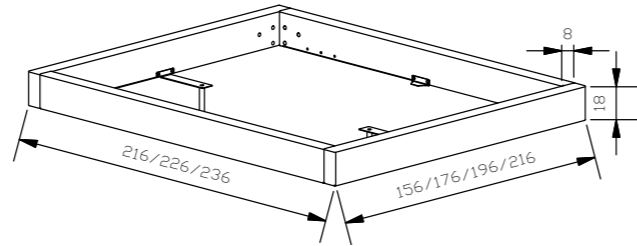

Sole 18/4S

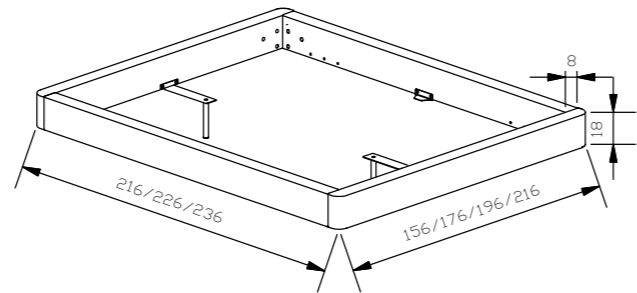

Alle Bettrahmen | Tous les cadres de lit | All bedframes

Breiten | Largeurs | Widths: 140, 160, 180, 200 cm

Längen | Longueurs | Lengths: 200, 210, 220 cm

Option:

Traversen siehe Seite 12.4

Traverses voir page 12.4

Bars see page 12.4

Bettkasten | Coffres à literie | Bedding boxes

nur bei Bettrahmen Moon und Sole | uniquement avec cadres de lit Moon et Sole | only with bedframes Moon and Sole

Practico-Box + Sole 18/4S
+ Ultrafree-Lift KF



Ultrafree-Lift KF



zu Practico-Box:
Lattenrost **Ultrafree-Lift KF**
Kopf-Fussverstellung, Gesamthöhe 11 cm
Rahmenholme Höhe 7 cm und 28 Federleisten
aus Buchenschichtholz

Lattenrost **Econom-move**
Unverstellbar, Gesamthöhe 9 cm
Rahmenholme Höhe 6 cm und 28 Federleisten
aus Buchenschichtholz
inkl. Gasdruckfedern und allen Beschlägen

Practico-Box + Moon 18/4S
+ Econom-move



Econom-move



pour box Practico :
Sommier **Ultrafree-Lift KF**
Tête et pied réglables, hauteur totale 11 cm
Cadre, hauteur 7 cm et 28 lattes en hêtre multiplis

Sommier **Econom-move**
Non réglable, hauteur totale 9 cm
Cadre, hauteur 6 cm et 28 lattes en hêtre multiplis
Pistons à gaz et toute la quincaillerie inclus

Stauraum | Compartiment de rangement | Storage space

140 × 200/210/220 = 131 × 190/200/210 × 24 cm

160 × 200/210/220 = 74 × 190/200/210 × 24 (2 x) cm

180 × 200/210/220 = 84 × 190/200/210 × 24 (2 x) cm

200 × 200/210/220 = 94 × 190/200/210 × 24 (2 x) cm

Details zu Ultrafree-Lift KF und Econom-move
siehe Register 14, Seite 14.8

Détails pour Ultrafree-Lift KF et Econom-move
voir registre 14, page 14.8

Details for Ultrafree-Lift KF and Econom-move
see index 14, page 14.8

for Practico box:
Slats **Ultrafree-Lift KF**
Head/footpiece adjustable, total height 11 cm
Frame, height 7 cm and 28 slats are of beech veneer board

Slats **Econom-move**
Not adjustable, total height 9 cm
Frame, height 6 cm and 28 slats are of beech veneer board
Pneumatic compression spring and all fittings included

Bettrahmen | Cadres de lit | Bedframes

4-seitig | 4 faces | 4-sided

Lungo 23/4S

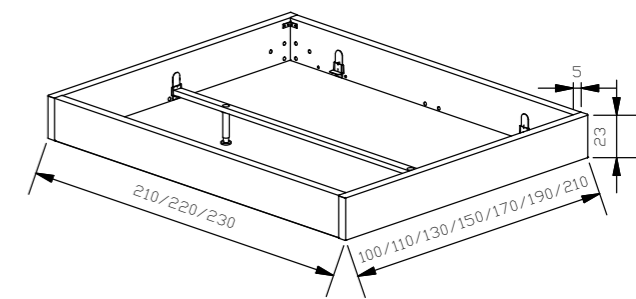

Lungo 28/4S

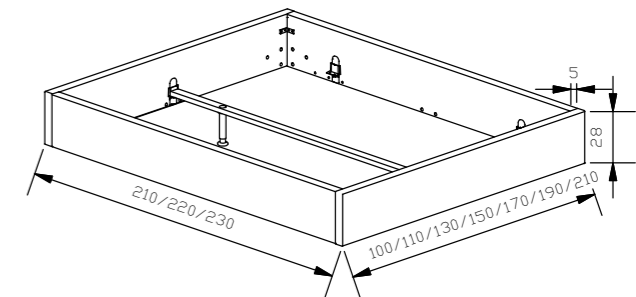

Ciara 23/4S

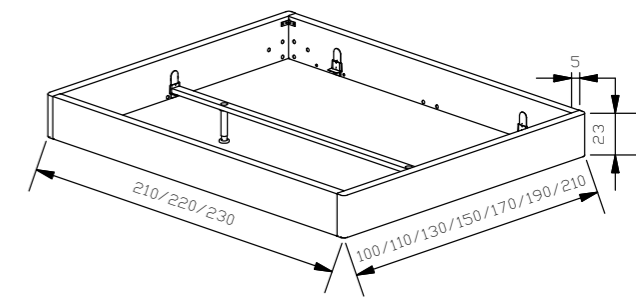

Ciara 28/4S

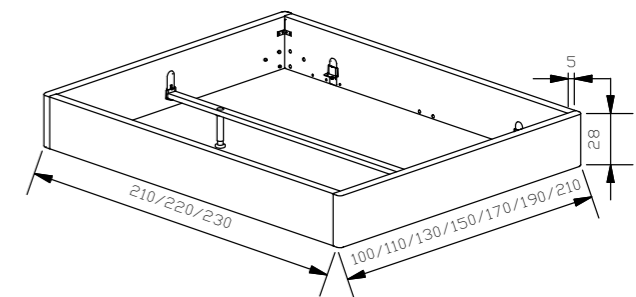

Alle Bettrahmen | Tous les cadres de lit | All bedframes

Breiten | Largeurs | Widths: 90, 100, 120, 140, 160, 180, 200 cm

Längen | Longueurs | Lengths: 200, 210, 220 cm

Stoffvielfalt siehe Seiten 11.16–11.17

Large choix de tissus voir pages 11.16–11.17
Large diversity of fabrics see pages 11.16–11.17

Ab 160 cm Midtraver-move inklusive siehe Seite 12.4

A partir de 160 cm Midtraver-move inclus voir page 12.4

From 160 cm Midtraver-move included see page 12.4



Bei Echtleder mit sichtbarer Naht auf Fläche | Pour cuir véritable avec surpiqûre en surface | For real leather with visible stitching on surface

Kopfteile | Têtes de lit | Headboards

gepolstert | rembourrées | upholstered

Arora

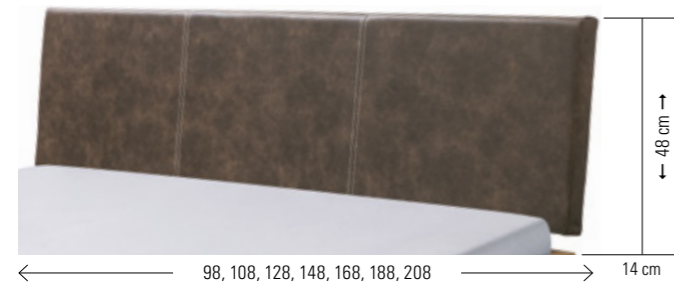

Dimension: 90, 100, 120, 140, 160, 180, 200

Cussina**



Dimension: 140, 160, 180, 200

Gabo



Dimension: 90, 100, 120, 140, 160, 180, 200

Lenio

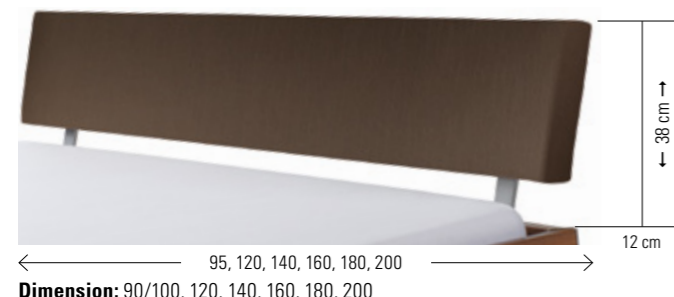

Dimension: 90/100, 120, 140, 160, 180, 200

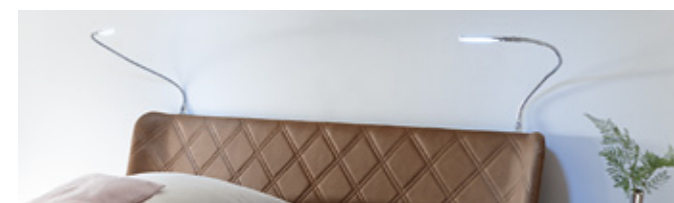

Boga



Dimension: 90, 100, 120, 140, 160, 180, 200

Elipsa**

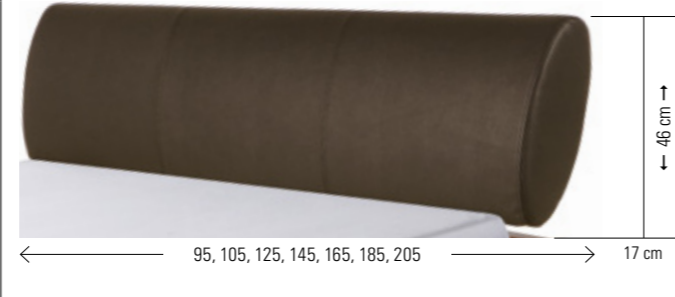

Dimension: 90, 100, 120, 140, 160, 180, 200

Lecco

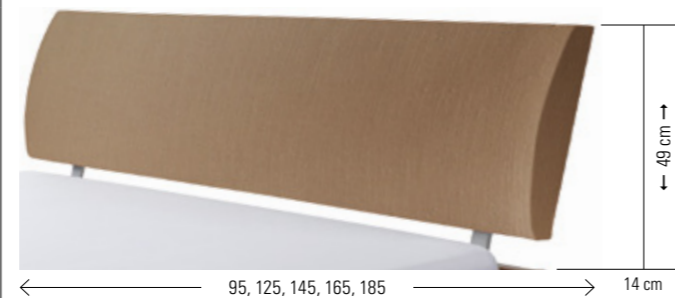

Dimension: 90/100, 120, 140, 160, 180/200

Malta

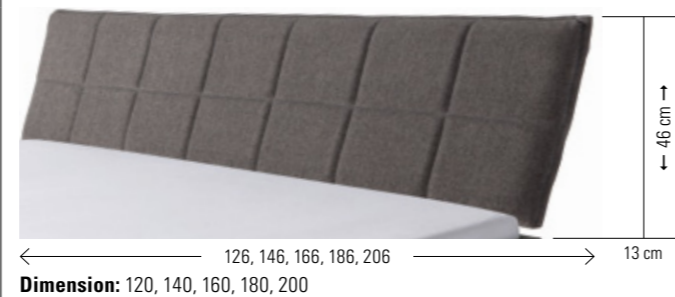

Dimension: 120, 140, 160, 180, 200

Leselampen für Kopfteile siehe Register 2, Seite 2.11
Lampes de lecture pour têtes de lit voir registre 2, page 2.11
Reading lamps for headboards see index 2, page page 2.11

****Leselampen nicht montierbar**
Montage de lampes de lecture impossible
No possibility to assemble reading lamps

Kopfteile | Têtes de lit | Headboards

gepolstert | rembourrées | upholstered

Obag**



Dimension: 140, 160, 180, 200

Ripo

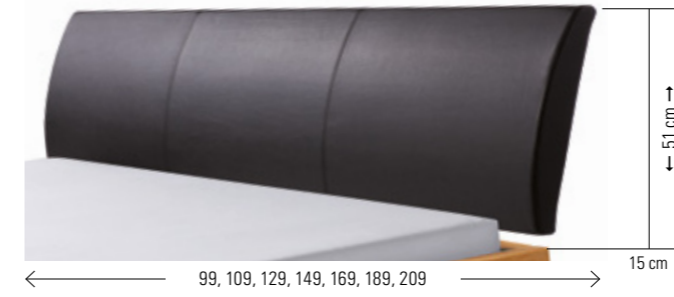

Dimension: 90, 100, 120, 140, 160, 180, 200

Ronna

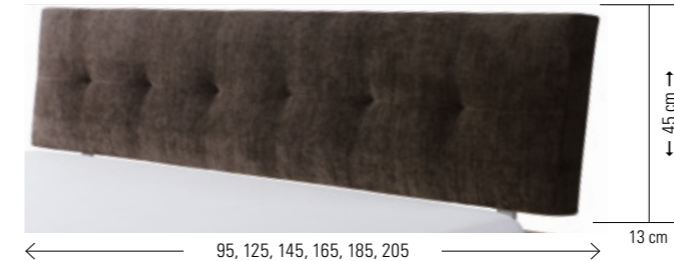

Dimension: 90/100, 120, 140, 160, 180, 200

Wandpaneele | Panneaux muraux | Wallpanels

Umbia L

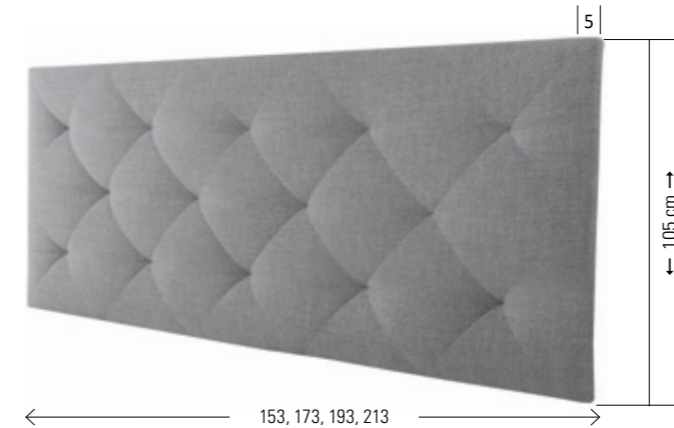

Weitere Paneele siehe Register 1, Seite 5
Autres panneaux muraux voir registre 1, page 5
Other wallpanels see index 1, page page 5

Talma**



Dimension: 140, 160, 180, 200

Suno



Dimension: 140, 160, 180, 200

Adapter | Adaptateur | Adapter

Bei hohen Matratzen kann mit dem Verlängerungsadapter das Kopfteil um 9 oder 13 cm erhöht werden.

La tête de lit peut être rehaussée de 9 ou 13 cm avec l'adaptateur lorsque le matelas est plus épais.

With the extension adapter the headboard can be extended 9 or 13 cm if mattresses are high.

Head-Plus
Metal | Métal | Metal

Head-Hold für Wasserbetten
pour lits d'eau | for waterbeds



Weitere Informationen siehe Register 1, Seite 5
Autres panneaux muraux voir registre 1, page 5
Other wallpanels see index 1, page page 5

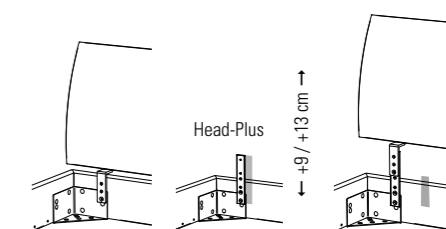

Füsse | Pieds | Feet

Holz | Bois | Wood



Holz Bois Wood	Masse cm Dim. cm	Höhen cm Hauteurs cm Heights cm			Holzfarben Couleurs bois Colours wood																				
		10	20	25	06	07	09	10	16	50	62	64	70	71	73	74	76	80	82	87	90	93	96	98	
Arc			•	•																					
Cantu	8×8		•	•	•	•	•	•	•	•	•	•	•	•	•	•	•	•	•	•	•	•	•	•	•
Gola			•	•																					
Ivio	10×10	•	•	•	•	•	•	•	•	•	•	•	•	•	•	•	•	•	•	•	•	•	•	•	•
Juve	8×8		•	•	•	•	•	•	•	•	•	•	•	•	•	•	•	•	•	•	•	•	•	•	•
Leno			•	•																					
Masi			•	•																					
Skid	140-200			•																					
Practico-Box* (inkl. Boden fond inclus bottom included)	140-200			•																					

*Practico-Box aus MDF ummantelt und nur mit Moon und Sole Rahmen kombinierbar | Practico-Box en mdf laminé et uniquement combinable avec les cadres Moon et Sole | Practico-Box in mdf coated and can only be combined with Moon and Sole frames

Holzfarben siehe Seite 2.13 | Couleurs bois voir page 2.13 | Wood colours see page 2.13



Füsse | Pieds | Feet

Metall | Métal | Metal

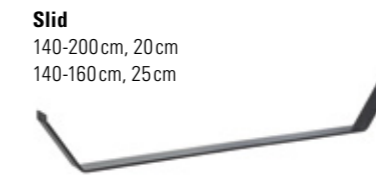
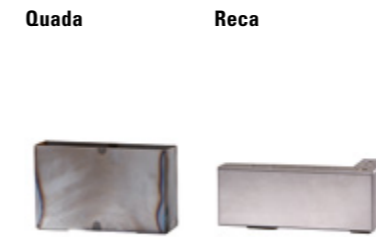

Metall Métal Metal	Masse cm Dim. cm	Breiten cm Largeurs cm Widths cm	Höhen cm Hauteurs cm Heights cm				Metallfarben Couleurs métal Colours metal																			
			10	20	25	30	00	04	10	16	40	41	42	43	45											
Caro	6×6			•	•		•																			
Facil				•																						
Fasio	∅ 5/9			•																						
Indus	6×2	140-200		•	•																					
Jeno	12×5		•	•	•																					
Mico	8×8		•	•	•																					
Quada	20×6,5			•	•																					
Reca	24×12		•																							
Road*	∅ 13			•																						
Slid	8/1	140-200		•	•																					
Soko	∅ 6			•	•																					
Stomp	∅ 8		•	•	•	•																				
Tondo	∅ 3,5			•																						

*Füsse fixiert, Rollen nur optisch | Pieds fixes, roulettes uniquement décoratives | Feet fixed, castors only visual

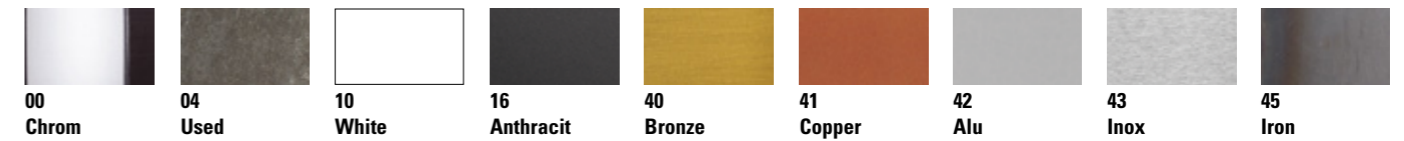

00 Chrom = Edelstahl poliert | Acier polié | Stainless steel polished
 04 Used = Stahl galvanisiert | Acier galvanisé | Steel galvanised
 10 White = Stahl pulverbeschichtet | Acier thermolaqué | Steel powder-coated
 16 Anthracit = Stahl pulverbeschichtet | Acier thermolaqué | Steel powder-coated
 40 Bronze = Stahl lackiert | Acier laqué | Steel lacquered
 41 Copper = Stahl lackiert | Acier laqué | Steel lacquered
 42 Alu = Stahl pulverbeschichtet | Acier thermolaqué | Steel powder-coated
 43 Inox = Edelstahl geschliffen | Acier poncé | Stainless steel ground
 45 Iron = Stahl geflammt, pulverbeschichtet | Acier flammé, thermolaqué | Steel mottled, powder-coated

Beimöbel | Accessoires | Accessories

Roll-Box 20/25



Bettkasten in weiss oder anthrazit (Boden weiss)

Voraussetzung

Bettfusshöhe von mindestens 20cm erforderlich

Optionen

Deckel Covero in weiss, Stoffabdeckung Saceto in Polyester grau.

Roll-Box 20/25 + Covero



Tiroir de lit en blanc ou anthracite (fond blanc)

Condition préalable

Une hauteur de pieds de lit d'au moins 20 cm est nécessaire

Options

Couvercle Covero en blanc, tissu de protection Saceto en polyester gris.

Roll-Box 20/25 + Saceto



Bed drawer in white or anthracite (bottom white)

Condition

Feet of bed need a minimum height of 20 cm

Options

Covero in white, tissue of protection Saceto in polyester grey.



Roll-Box 20

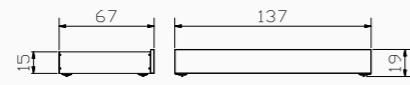

Roll-Box 25

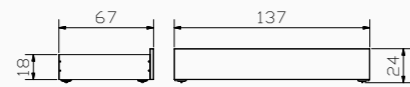

Stauraum | Espace de rangement | Storage space

Roll-Box 20	=	134 × 61 × 13 cm
Roll-Box 25	=	134 × 61 × 16 cm

Ausführungen der Roll-Box-Fronten | Exécutions des façades des Roll-Box | Executions of the Roll-Box fronts

Holz massiv | Bois massif | Solid wood

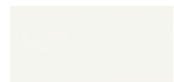

10 Buche weiss deckend, lackiert
Hêtre blanc couvrant, laqué
Beech white covered, lacquered



16 Buche anthracit deckend, lackiert
Hêtre anthracite couvrant, laqué
Beech anthracite covered, lacquered



71 Eiche bianco, geölt
Chêne bianco, huilé
Oak bianco, oiled



73 Eiche bianco, gebürstet, geölt
Chêne bianco, brossé, huilé
Oak bianco, brushed, oiled



74 Eiche bright, geölt
Chêne bright, huilé
Oak bright, oiled



80 Kernbuche natur, geölt
Hêtre coeur rouge naturel, huilé
Heart beech natural, oiled



86 Eiche natur, gebürstet, geölt
Chêne naturel, brossé, huilé
Oak natural, brushed, oiled



91 Eiche cognac, gebürstet, geölt
Chêne cognac, brossé, huilé
Oak cognac, brushed, oiled



93 Wildeiche natur, gebürstet, geölt
Chêne nouveaux naturel, brossé, huilé
Wildoak natural, brushed, oiled



selezione

01

MODELLAUSWAHL

Sélection du modèle | Model selection

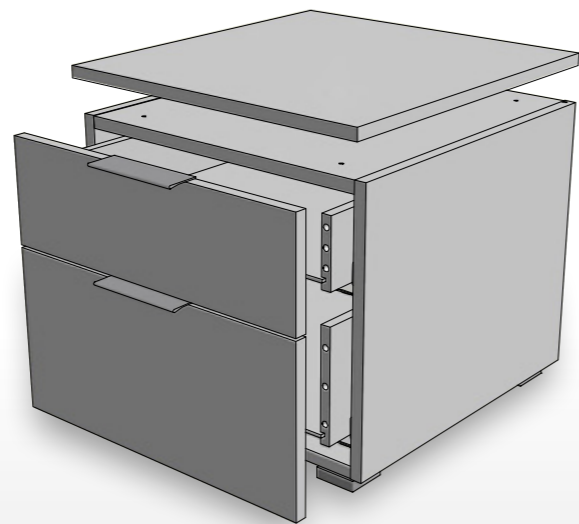

02

KORPUS

Caisson | Body



03

TOP/FRONT

Farben | Couleurs | Colours



04

GRIFFE

Poignées | Handles



Stellen Sie sich Ihr Wunsch-Beimöbel nach Ihrem Geschmack zusammen: Der Korpus (Abb. 02), in zwei verschiedenen Farbvarianten, lässt sich zu den Front- und Top-Covern (Abb. 03) in acht Holz- und Farbausführungen kombinieren. Die Beimöbel können zerlegt oder teilmontiert bestellt werden. Bei zusammengesetzten Möbeln (z. B. Qunito, Incentro, ...) muss der Deckel noch montiert werden. Bei Kommoden mit Türen ist jeweils ein Einlegeboden vorhanden, Türöffnung nach links oder rechts möglich. Zusätzliche Böden sind erhältlich.

Composez le meuble d'appoint de vos rêves selon vos goûts : Le caisson (ill. 02), disponible en 2 variantes de couleurs, peut être combiné avec les façades et couvercles supérieurs (ill. 03) en 8 finitions de bois et de coloris. Les meubles d'appoint peuvent être commandés en kits ou assemblés. Pour les meubles assemblés (p. ex. Qunito, Incentro, ...) le couvercle doit encore être fixé. Les commodes avec portes sont équipées d'une étagère, ouverture de la porte possible à gauche ou à droite. Si besoin, des étagères supplémentaires sont disponibles.

Put together the side furniture you want according to your own taste: The body (fig. 02), in two different colour versions, can be combined with the front and top covers (fig. 03) in eight wood and colour versions. The furniture can be ordered disassembled or assembled. For assembled furniture (e.g. Qunito, Incentro, ...) the top cover must still be fitted. Chests of drawers with doors have one shelf, door opening possible to the left or right. Additional shelves are available.



Kombinationsbeispiele und techn. Informationen
Exemples et informations
Examples and informations

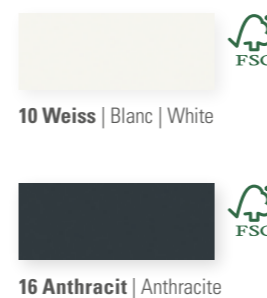

STANDARD



OPTION

Leg 8 cm Jone 10 cm Cila 10 cm

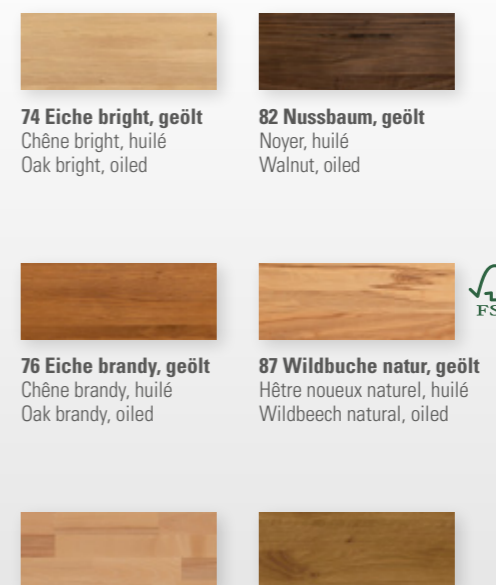
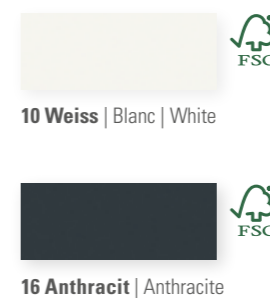

STANDARD



Alu
Griff zu Folienfronten
Poignée pour façades en mélaminé
Handle for foil fronts

STANDARD



Holzgriff zu Holzfronten
Poignée en bois pour façades en bois
Wooden handle for wooden fronts

OPTION

Rivo

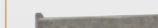

Used



Anthracit

Metallgriff zu Holzfronten

Poignée en métal pour façades en bois
Metal handle for wooden fronts



Lattenroste | Sommier | Slats



Dritto U

U = Unverstellbar
Non réglable
Not adjustable

Rahmenholme und 14 Federleisten aus Buchenschichtholz
Cadre et 14 lattes en hêtre multiplis
Frame and 14 slats are of beech veneer board

Starre Lagerung
Suspension rigide
Rigid suspension

Längen | Longueurs | Lengths

200

Höhe | Hauteur | Height: 6 cm

Keine Sondermasse möglich | Dimensions spéciales non disponibles |
No special sizes possible

Breiten | Largeurs | Widths

80	90	100	120	140
●	●	●	●	●



Flexo K

K = Kopfteil manuell 13-fach verstellbar
Réglage manuel de la tête en 13 positions
Head piece manually adjustable in 13 positions

Rahmenholme und 28 Federleisten aus Buchenschichtholz
Cadre et 28 lattes en hêtre multiplis
Frame and 28 slats are of beech veneer board

Flexible Lagerung
Suspension flexible
Flexible suspension

Schulterkomfortzone
Zone de confort des épaules
Comfort zone for shoulders

Mittelzonenverstärkung
Zone médiane renforcée
Reinforcement of the middle zone



Längen | Longueurs | Lengths

200, 210, 220

Höhe | Hauteur | Height: 9 cm

Keine Sondermasse möglich | Dimensions spéciales non disponibles |
No special sizes possible

Breiten | Largeurs | Widths

80	90	100	120	140
●	●	●	●	●



Ultrafree RF

RF = Rücken- und Fussteil manuell je 13-fach verstellbar
Réglage manuel pour le haut du corps et les jambes en 13 positions
Back and foot sections manually adjustable in 13 positions

Rahmenholme und 30 Federleisten aus Buchenschichtholz
Cadre et 30 lattes en hêtre multiplis
Frame and 30 slats are of beech veneer board

Details siehe Seite 13.2–13.3
Détails voir page
Details see page: 13.2–13.3



Längen | Longueurs | Lengths

200, 210, 220

Höhe | Hauteur | Height: 10 cm

Keine Sondermasse möglich | Dimensions spéciales non disponibles |
No special sizes possible

Breiten | Largeurs | Widths

80	90	100	120	140
●	●	●	●	●

Matratzen | Matelas | Mattresses

Novo

7-Zonen-Kaltschaumkern, Höhe 8 cm in Härtegrad H3 (RG 35) erhältlich
7-zones noyau en mousse froide, hauteur 8 cm disponible dans le degré de fermeté f3 (densité 35)
7-zones core cold foam, height 8 cm available in the degree of hardness H3 (density 35)

Optimale Unterstützung durch 7-Zonen-Kaltschaum-Noppenprofil in 2.5 cm Stärke
Soutien optimal grâce à une mousse 7-zones froide à picots 2.5 cm
Optimum support through 7-zones cold foam upholstery 2.5 cm with nobs

Breiten | Largeurs | Widths 80, 90, 100, 120, 140, 160, 180, 200 cm

Längen | Longueurs | Lengths 200, 210, 220 cm

Höhe | Hauteur | Height 16 cm

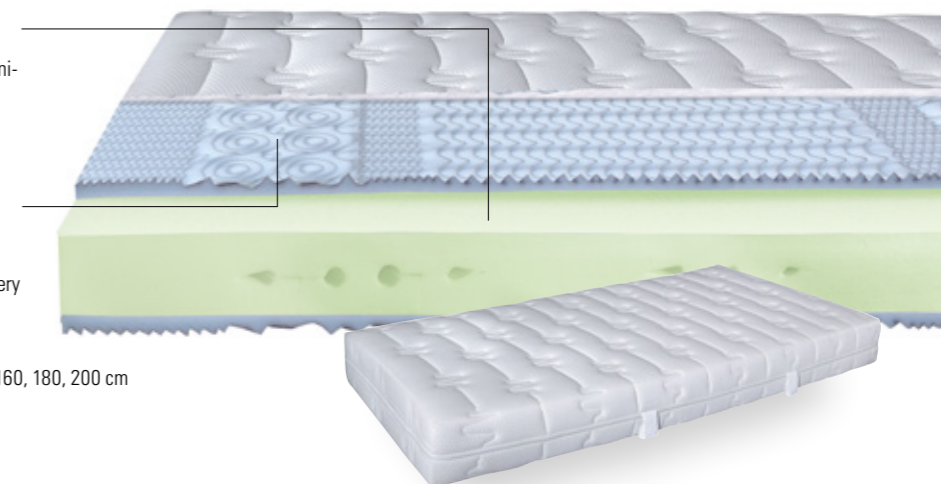

Ultraconfort

7-Zonen-Kaltschaumkern, Höhe 12 cm in den Härtegraden H3 (RG 45) und H4 (RG 50) erhältlich
7-zones noyau en mousse froide, hauteur 12 cm disponible dans les degrés de fermeté f3 (densité 45) et f4 (densité 50)
7-zones core cold foam, height 12 cm available in the degrees of hardness H3 (density 45) and H4 (density 50)

Optimale Unterstützung und Klimatisierung durch 4 cm Soft-Kaltschaum-Auflage RG 60
Soutien optimal et climatisation idéale grâce à une mousse froide souple 4 cm densité 60
Optimum support and climate regulation through 4 cm soft cold foam upholstery density 60

Breiten | Largeurs | Widths 80, 90, 100, 120, 140, 160, 180, 200 cm

Längen | Longueurs | Lengths 200, 210, 220 cm

Höhe | Hauteur | Height 21 cm

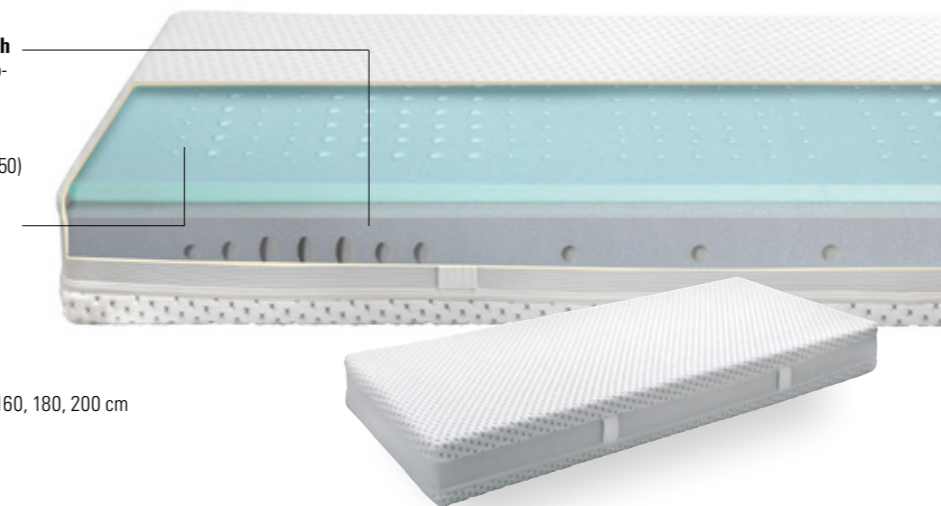

Ultramotion

7-Zonen-Kaltschaum-Tröpfchenkern mit Querbelüftung und Schulterzone, Höhe 20 cm in den Härtegraden H2 (RG 53), H3 (RG 53) und H4 (RG 45) erhältlich

7-zones noyau de gouttelettes en mousse froide avec ventilation transversale et zone pour les épaules, hauteur 20 cm disponible dans les degrés de fermeté f2 (densité 53), f3 (densité 53) et f4 (densité 45)
7-zones cold foam droplet core with lateral ventilation and shoulder zone, height 20 cm available in the degrees of hardness H2 (density 53), H3 (density 53) and H4 (density 45)

Breiten | Largeurs | Widths 80, 90, 100, 120, 140, 160, 180, 200 cm

Längen | Longueurs | Lengths 200, 210, 220 cm

Höhe | Hauteur | Height 23 cm



Informationen zu Matratzenbezügen und weitere Lattenroste und Matratzen siehe Register 13

Informations sur les housses de matelas et autres sommier et matelas, voir registre 13
Information on mattress covers and other slatted frames and mattresses, see tab 13.



				Dimension cm
Twia	Nachttisch	Table de nuit	Bedside table	45/47/41
Atrine	Kommode	Commode	Chest of drawers	90/49/85

				Dimension cm
Lungo 28/3S	Rahmen Breiten Längen	Cadre Largeurs Longueurs	Frame Widths Lengths	140, 160, 180, 200 200, 210, 220
Ivio	Füße Höhen	Pieds Hauteurs	Feet Heights	10, 20, 25
Zuro	Kopfteil	Tête de lit	Headboard	140, 160, 180, 200

Alle Polsterteile in Real notte 516 | Toutes les parties rembourrées en Real notte 516 | All upholstery parts in Real notte 516

Alle Holzteile in Akazie Vintage grey, lackiert | Toutes les parties en bois en acacia vintage grey, laqué | All wooden parts in acacia vintage grey, lacquered

Twia, Atrine: Anthracit | Anthracite

Weitere Beimöbel siehe Register 2 | Autres accessoires voir registre 2 | Further accessories see index 2

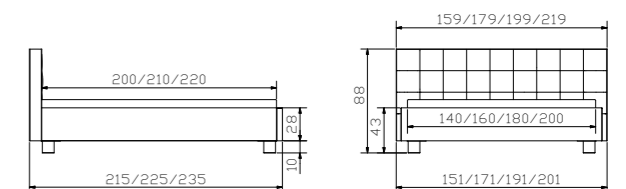



				Dimension cm
Sola	Bank	Banquette	Bench	140/37/38
Styly	Nachttisch	Table de nuit	Bedside table	43/43/48

				Dimension cm
Ciara 23/4S	Rahmen Breiten Längen	Cadre Largeurs Longueurs	Frame Widths Lengths	90, 100, 120, 140, 160, 180, 200 200, 210, 220
Arc	Füße Höhen	Pieds Hauteurs	Feet Heights	20, 25
Ripo	Kopfteil	Tête de lit	Headboard	90, 100, 120, 140, 160, 180, 200

Alle Polsterteile in Kitana grigio 602 | Toutes les parties rembourrées en Kitana grigio 602 | All upholstery parts in Kitana grigio 602

Alle Holzteile in Eiche bright, geölt | Toutes les parties en bois en chêne bright, huilé | All wooden parts in oak bright, oiled

Weitere Beimöbel siehe Register 2 | Autres accessoires voir registre 2 | Further accessories see index 2

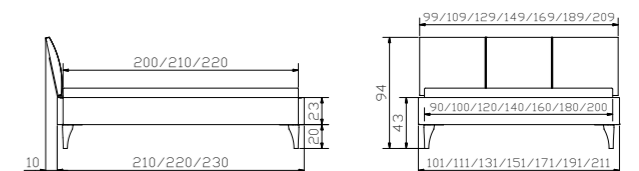



				Dimension cm
Topa anthracit	Bank inkl. Kissen	Banquette, Coussin incl.	Bench, incl. cushion	144/44/38
Incentro	Kommode	Commode	Chest of drawers	135/50/86
Nali anthracit	Nachttisch	Table de nuit	Bedside table	∅ 48/52

				Dimension cm
Ciara 23/3S	Rahmen Breiten Längen	Cadre Largeurs Longueurs	Frame Widths Lengths	140, 160, 180, 200 200, 210, 220
Tondo anthracit	Füße Höhe	Pieds Hauteur	Feet Height	20
Julia	Kopfteil	Tête de lit	Headboard	140, 160, 180, 200

Alle Polsterteile in Boston turtle 653 | Toutes les parties rembourrées en Boston turtle 653 | All upholstery parts in Boston turtle 653

Alle Holzteile in Kernbuche natur, geölt | Toutes les parties en bois en hêtre coeur rouge naturel, huilé | All wooden parts in heart beech natural, oiled

Incentro: Korpus anthracit | Caisson anthracite | Body anthracite

Weitere Beimöbel siehe Register 2 | Autres accessoires voir registre 2 | Further accessories see index 2

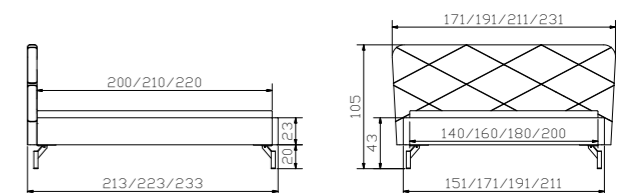



Nali bronze	Nachttisch	Table de nuit	Bedside table	Dimension cm Ø 48/52
--------------------	------------	---------------	---------------	--------------------------------

Sole 18/3S	Rahmen Breiten Längen	Cadre Largeurs Longueurs	Frame Widths Lengths	Dimension cm 140, 160, 180, 200 200, 210, 220
Ivio	Füße Höhen	Pieds Hauteurs	Feet Heights	10, 20, 25
Coco	Kopfteil	Tête de lit	Headboard	140, 160, 180, 200

Alle Polsterteile in Capo linen 763 | Toutes les parties rembourrées en Capo linen 763 | All upholstery parts in Capo linen 763
Alle Holzteile in Buche weiss deckend, lackiert | Toutes les parties en bois en hêtre blanc couvrant, laqué | All wooden parts in beech white covered, lacquered
Weitere Beimöbel siehe Register 2 | Autres accessoires voir registre 2 | Further accessories see index 2

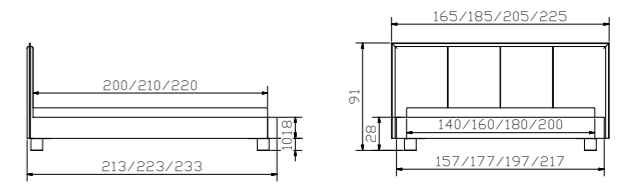



Dimension cm

Twia	Nachttisch	Table de nuit	Bedside table	45/50/41
Quatro	Kommode	Commode	Chest od drawers	45/50/86

Dimension cm

Sole 18/4S	Rahmen Breiten Längen	Cadre Largeurs Longueurs	Frame Widths Lengths	140, 160, 180, 200 200, 210, 220
Jeno used	Füße Höhen	Pieds Hauteurs	Feet Heights	10, 20, 25
Boga	Kopfteil	Tête de lit	Headboard	140, 160, 180, 200

Alle Polsterteile in Echtleder Real creta 507 | Toutes les parties rembourrées en cuir véritable Real creta 507 | All upholstery parts in real leather Real creta 507

Alle Holzteile in Nussbaum, geölt | Toutes les parties en bois en noyer, huilé | All wooden parts in walnut, oiled

Twia, Quatro: Korpus anthracit | Caisson anthracite | Body anthracite

Weitere Beimöbel siehe Register 2 | Autres accessoires voir registre 2 | Further accessories see index 2

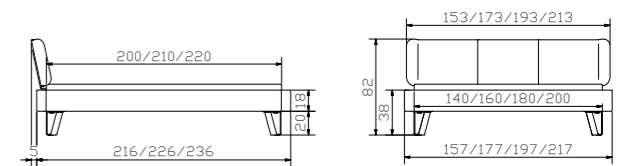

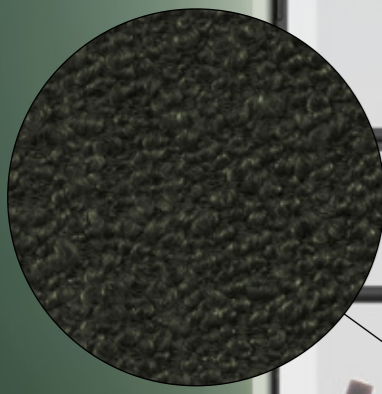

				Dimension cm
Nali anthracit	Nachttisch	Table de nuit	Bedside table	Ø 48/52
Topa anthracit	Bank inkl. Kissen	Banquette, Coussin incl.	Bench, Cushion incl.	144/44/38

				Dimension cm
Moon 18/4S	Rahmen Breiten Längen	Cadre Largeurs Longueurs	Frame Widths Lengths	140, 160, 180, 200 200, 210, 220
Tondo anthracit	Füße Höhe	Pieds Hauteur	Feet Height	20
Talma	Kopfteil	Tête de lit	Headboard	140, 160, 180, 200

Alle Polsterteile in Boucle fresco 772 | Toutes les parties rembourrées en Boucle fresco 772 | All upholstery parts in Boucle fresco 772
Alle Holzteile in Nussbaum, geölt | Toutes les parties en bois en noyer, huilé | All wooden parts in walnut, oiled
Weitere Beimöbel siehe Register 2 | Autres accessoires voir registre 2 | Further accessories see index 2

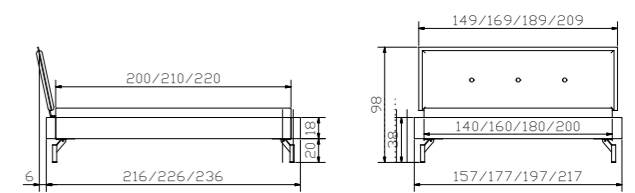



Dimension cm

Quatrine	Kommode	Commode	Chest od drawers	90/50/86
Lina anthracit	Nachttisch	Table de nuit	Bedside table	Ø 45/52

Dimension cm

Moon 18/3S	Rahmen Breiten Längen	Cadre Largeurs Longueurs	Frame Widths Lengths	140, 160, 180, 200 200, 210, 220
Slid anthracit	Kufen Breiten Höhen	Patins Largeurs Hauteurs	Vats Widths Heights	140, 160, 180, 200 20, 25
Orion	Kopfteil	Tête de lit	Headboard	140, 160, 180, 200

Alle Polsterteile in Boucle ivory 770 | Toutes les parties rembourrées en Boucle ivory 770 | All upholstery parts in Boucle ivory 770

Alle Holzteile in Nussbaum, geölt | Toutes les parties en bois en noyer, huilé | All wooden parts in walnut, oiled

Quatrine: Korpus anthracit | Caisson anthracite | Body anthracite

Weitere Beimöbel siehe Register 2 | Autres accessoires voir registre 2 | Further accessories see index 2

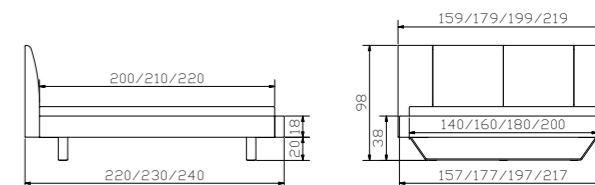



				Dimension cm
Quatrine	Kommode	Commode	Chest od drawers	90/50/86
Topa copper	Bank inkl. Kissen	Banquette, Coussin incl.	Bench, cushion incl.	144/44/38
Lina copper	Nachttisch	Table de nuit	Bedside table	Ø 45/52

				Dimension cm
Ciara 23/3S	Rahmen Breiten Längen	Cadre Largeurs Longueurs	Frame Widths Lengths	140, 160, 180, 200 200, 210, 220
Fasio copper	Füße Höhe	Pieds Hauteur	Feet Height	20
Mars	Kopfteil	Tête de lit	Headboard	140, 160, 180, 200

Alle Polsterteile in Ranch grit 661 | Toutes les parties rembourrées en Ranch grit 661 | All upholstery parts in Ranch grit 661

Alle Holzteile in Buche weiss deckend, lackiert oder anthracit | Toutes les parties en bois en hêtre blanc couvrant, laqué ou anthracite | All wooden parts in beech white covered, lacquered or anthracite

Weitere Beimöbel siehe Register 2 | Autres accessoires voir registre 2 | Further accessories see index 2

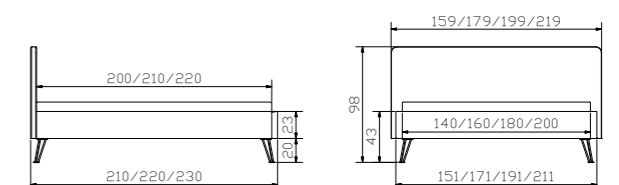



Dimension cm

Lina anthracit	Nachttisch	Table de nuit	Bedside table
Snake anthracit	Leselampe (2er Set) 12V DC, 6 LED	Lampe de lecture (set de 2) 12V DC, 6 LED	Reading lamp (set of 2) 12V DC, 6 LED

Ø 45/52

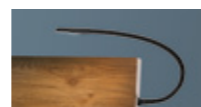

Dimension cm

Sole 18/3S	Rahmen Breiten Längen	Cadre Largeurs Longueurs	Frame Widths Lengths	140, 160, 180, 200 200, 210, 220
Skid	Kufen Breiten Höhe	Patins Largeurs Hauteur	Vats Widths Height	140, 160, 180, 200 25
Siena	Kopfteil	Tête de lit	Headboard	140, 160, 180, 200

Alle Polsterteile in Fusio shell 750 | Toutes les parties rembourrées en Fusio shell 750 | All upholstery parts in Fusio shell 750

Alle Holzteile in Eiche bianco, gebürstet, geölt | Toutes les parties en bois en chêne bianco, brossé, huilé | All wooden parts in oak bianco, brushed, oiled

Leselampen und weitere Beimöbel siehe Register 2 | Lampes de lecture et autres accessoires voir registre 2 | Reading lamps and further accessories see index 2

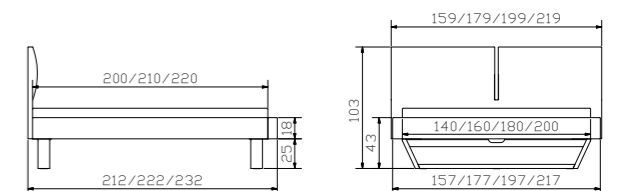



Dimension cm				
Noma	Nachttisch	Table de nuit	Bedside table	48/43/47
Sima 10	Füße	Pieds	Feet	
Circo 44	Nachttisch	Table de nuit	Bedside table	∅ 45/44
Circo 52	Nachttisch	Table de nuit	Bedside table	∅ 45/52
Sigma	Kommode	Commode	Chest of drawers	120/49/76
Sima 10	Füße	Pieds	Feet	

Dimension cm				
Sole 18/4S	Rahmen Breiten Längen	Cadre Largeurs Longueurs	Frame Widths Lengths	140, 160, 180, 200 200, 210, 220
Masi	Füße Höhen	Pieds Hauteurs	Feet Heights	10, 20, 25
Obag	Kopfteil	Tête de lit	Headboard	140, 160, 180, 200

Alle Polsterteile in Ranch stone 660 | Toutes les parties rembourrées en Ranch stone 660 | All upholstery parts in Ranch stone 660

Alle Holzteile in Nussbaum, geölt | Toutes les parties en bois en noyer, huilé | All wooden parts in walnut, oiled

Weitere Beimöbel siehe Register 2 | Autres accessoires voir registre 2 | Further accessories see index 2

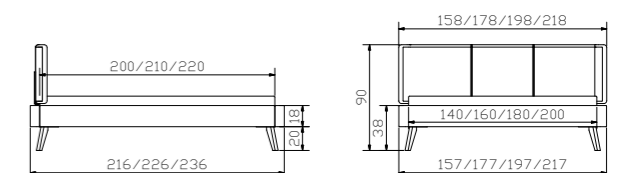



Dimension cm

Quatro	Kommode	Commode	Chest od drawers	45/50/86
Nali bronze	Nachttisch	Table de nuit	Bedside table	∅ 48/52

Dimension cm

Sole 18/4S	Rahmen Breiten Längen	Cadre Largeurs Longueurs	Frame Widths Lengths	140, 160, 180, 200 200, 210, 220
Arc	Füße Höhen	Pieds Hauteurs	Feet Heights	20, 25
Cussina	Kopfteil	Tête de lit	Headboard	140, 160, 180, 200

Alle Polsterteile in Fusio anthracit 751 | Toutes les parties rembourrées en Fusio anthracit 751 | All upholstery parts in Fusio anthracit 751

Alle Holzteile in Eiche bright, geölt | Toutes les parties en bois en chêne bright, huilé | All wooden parts in oak bright, oiled

Quatro: Korpus anthracit | Caisson anthracite | Body anthracite

Nachttisch in Eiche bianco, gebürstet, geölt | Table de nuit en chêne bianco, brossé, huilé | Bedside table in oak bianco, brushed, oiled

Weitere Beimöbel siehe Register 2 | Autres accessoires voir registre 2 | Further accessories see index 2

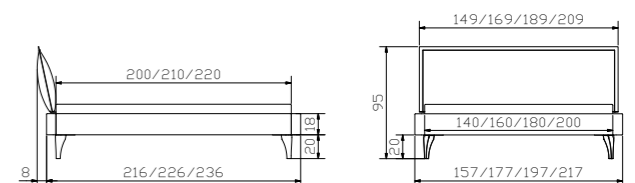



Dimension cm

Twia	Nachttisch	Table de nuit	Bedside table	45/50/41
Smart black	Leselampe (2er Set) schwarz 12V DC, 30 LED warm	Lampe de lecture (set de 2) noir 12V DC, 30 LED warm	Reading lamp (set of 2) nero 12V DC, 30 LED warm	
+Combino	Lampenadapter siehe Seite 12.3	Adaptateur pour des lampes voir page 12.3	Adapter for the lamps see page 12.3	

Dimension cm

Lungo 23/2S	Rahmen Längen	Cadre Longueurs	Frame Lengths	200, 210, 220
Slid anthracit	Kufen Breiten Höhen	Patins Largeurs Hauteurs	Vats Widths Heights	140, 160, 180, 200 20, 25
Venus	Kopfteil/Fussteil	Tête de lit/Pied de lit	Headboard/footboard	90, 100, 120, 140, 160, 180, 200

Alle Polsterteile in Boucle mouse 773 | Toutes les parties rembourrées en Boucle mouse 773 | All upholstery parts in Boucle mouse 773

Alle Holzteile in Eiche bright, geölt | Toutes les parties en bois en chêne bright, huilé | All wooden parts in oak bright, oiled

Twia: Korpus anthracit | Caisson anthracite | Body anthracite

Leselampen und weitere Beimöbel siehe Register 2 | Lampes de lecture et autres accessoires voir registre 2 | Reading lamps and further accessories see index 2

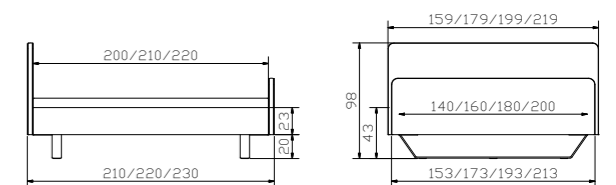



				Dimension cm
Topa bronze	Bank inkl. Kissen	Banquette, Coussin incl.	Bench, cushion incl.	144/44/38
Lina bronze	Nachttisch	Table de nuit	Bedside table	Ø 45/52

				Dimension cm
Lungo 23/2S	Rahmen Längen	Cadre Longueurs	Frame Lengths	200, 210, 220
Fasio bronze	Füße Höhe	Pieds Hauteur	Feet Height	20
Combia	Kopfteil/Fussteil	Tête de lit/pied de lit	Headboard/footboard	140, 160, 180, 200

Alle Polsterteile in Fusio musk 752 | Toutes les parties rembourrées en Fusio musk 752 | All upholstery parts in Fusio musk 752
Alle Holzteile in Nussbaum, geölt | Toutes les parties en bois en noyer, huilé | All wooden parts in walnut, oiled
Weitere Beimöbel siehe Register 2 | Autres accessoires voir registre 2 | Further accessories see index 2

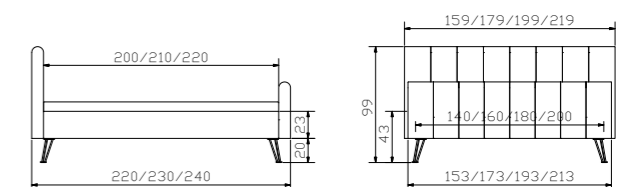



				Dimension cm
Onia	Nachttisch	Table de nuit	Bedside table	45/50/41
Jone 10	Füße	Pieds	Feet	10
Scola	Sekretär höhenverstellbar Schreibtischunterlage in Casual carbon 334	Secrétaire réglable en hauteur Sous-main de bureau en Casual carbon 334	Bureau adjustable in height Deskpad in Casual carbon 334	120/70/72-88

				Dimension cm
Lungo 23/3S	Rahmen Breiten Längen	Cadre Largeurs Longueurs	Frame Widths Lengths	140, 160, 180, 200 200, 210, 220
Jeno anthracit	Füße Höhen	Pieds Hauteurs	Feet Heights	10, 20, 25
Zuro M	Kopfteil	Tête de lit	Headboard	140, 160, 180, 200

Alle Polsterteile in Echtleder Real falda 513 | Toutes les parties rembourrées en cuir véritable Real falda 513 | All upholstery parts in real leather Real falda 513

Alle Holzteile in Akazie Vintage grey oder anthracit | Toutes les parties en bois en acacia Vintage grey ou anthracite | All wooden parts in acacia Vintage grey or anthracite

Weitere Beimöbel siehe Register 2 | Autres accessoires voir registre 2 | Further accessories see index 2

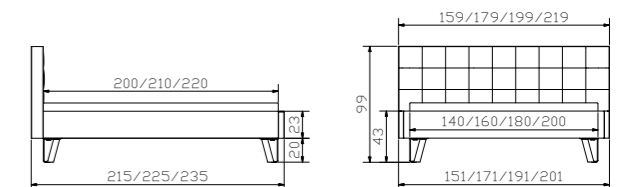



Dimension cm

Aska	Sekretär	Secrétaire	Bureau	120/60/85
Circo 44	Nachttisch	Table de nuit	Bedside table	Ø 45/44
Sola Topia	Bank Kissen	Banquette Coussin	Bench Cushion	140/37/38
Smart white	Leselampe (2er Set) weiss 12V DC, 30 LED warm	Lampe de lecture (Set de 2) blanc 12V DC, 30 LED warm	Reading lamp (Set of 2) white 12V DC, 30 LED warm	
+ Combino	Lampenadapter siehe Seite 12.3	Adaptateur pour des lampes voir page 12.3	Adapter for the lamps see page 12.3	

Alle Polsterteile in Capo linen 763 | Toutes les parties rembourrées en Capo linen 763 | All upholstery parts in Capo linen 763
Alle Holzteile in Eiche bianco, gebürstet, geölt | Toutes les parties en bois en chêne bianco, brossé, huilé | All wooden parts in oak bianco, brushed, oiled
Füsse und Bank in Eiche bright, geölt | Pieds et banquette en chêne bright, huilé | Feet and bench in oak bright, oiled
Leselampen und weitere Beimöbel siehe Register 2 | Lampes de lecture et autres accessoires voir registre 2 | Reading lamps and further accessories see index 2

Dimension cm

Lungo 28/2S	Rahmen Längen	Cadre Longueurs	Frame Lengths	200, 210, 220
Arc	Füsse Höhen	Pieds Hauteurs	Feet Heights	20, 25
Ronio	Kopfteil/Fussteil	Tête de lit/Pied de lit	Headboard/Footboard	90, 100, 120, 140, 160, 180, 200

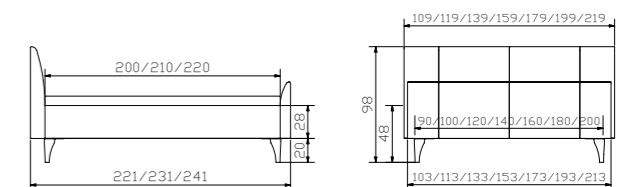



				Dimension cm
Totriino	Kommode	Commode	Chest od drawers	135/49/85
Styly	Nachttisch	Table de nuit	Bedside table	43/43/48
Smart white	Leselampe (2er Set) weiss 12V DC, 30 LED warm	Lampe de lecture (Set de 2) blanc 12V DC, 30 LED warm	Reading lamp (Set of 2) white 12V DC, 30 LED warm	

				Dimension cm
Ciara 23/4S	Rahmen Breiten Längen	Cadre Largeurs Longueurs	Frame Widths Lengths	140, 160, 180, 200 200, 210, 220
Slid white	Kufen Breiten Höhen	Patins Largeurs Hauteurs	Vats Widths Heights	140, 160, 180, 200 20, 25
Suno	Kopfteil	Tête de lit	Headboard	140, 160, 180, 200

Alle Polsterteile in Campos blanc 372 | Toutes les parties rembourrées en Campos blanc 372 | All upholstery parts in Campos blanc 372

Alle Holzteile in Buche weiss deckend, lackiert oder weiss | Toutes les parties en bois en hêtre blanc couvrant, laqué ou blanc | All wooden parts in beech white covered, lacquered or white

Leselampen und weitere Beimöbel siehe Register 2 | Lampes de lecture et autres accessoires voir registre 2 | Reading lamps and further accessories see index 2

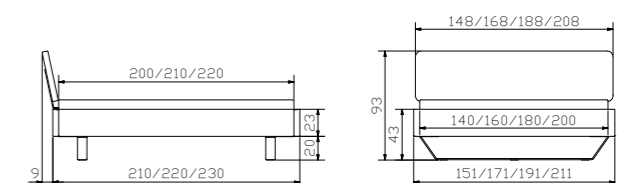



				Dimension cm
Sola	Bank	Banquette	Bench	140/37/38
Noma	Nachttisch	Table de nuit	Bedside table	48/43/47
Sima 10	Füsse	Pieds	Feet	
Sigma	Kommode	Commode	Chest of drawers	120/49/76
Sima 10	Füsse	Pieds	Feet	

				Dimension cm
Ciara 28/3S	Rahmen Breiten Längen	Cadre Largeurs Longueurs	Frame Widths Lengths	140, 160, 180, 200 200, 210, 220
Masi	Füsse Höhen	Pieds Hauteurs	Feet Heights	10, 20, 25
Kimo	Kopfteil	Tête de lit	Headboard	140, 160, 180, 200



Alle Polsterteile in Capo rose 762 oder Kitana grigio 602
Toutes les parties rembourrées en Capo rose 762 ou Kitana grigio 602
All upholstery parts in Capo rose 762 or Kitana grigio 602

Alle Holzteile in Eiche bianco, gebürstet, geölt
Toutes les parties en bois en chêne bianco, brossé, huilé
All wooden parts in oak bianco, brushed, oiled

Weitere Beimöbel siehe Register 2
Aautres accessoires voir registre 2
Further accessories see index 2

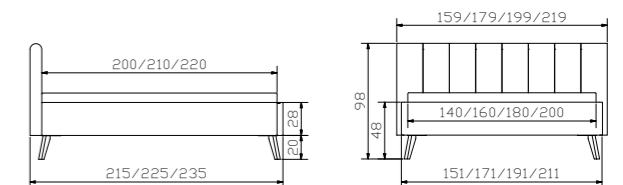



				Dimension cm
Trigo	Nachttisch	Table de nuit	Bedside table	48/43/55

				Dimension cm
Ciara 28/3S	Rahmen Breiten Längen	Cadre Largeurs Longueurs	Frame Widths Lengths	140, 160, 180, 200 200, 210, 220
Ivio	Füße Höhen	Pieds Hauteurs	Feet Heights	10, 20, 25
Damo	Kopfteil	Tête de lit	Headboard	140, 160, 180, 200

Alle Polsterteile in Casual olive 333 | Toutes les parties rembourrées en Casual olive 333 | All upholstery parts in Casual olive 333

Alle Holzteile in Nussbaum, geölt | Toutes les parties en bois en noyer, huilé | All wooden parts in walnut, oiled

Weitere Beimöbel siehe Register 2 | Autres accessoires voir registre 2 | Further accessories see index 2

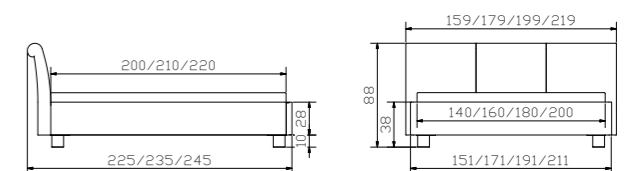



				Dimension cm
Lovara	Kommode	Commode	Chest of drawers	90/40/75
Dupla	Nachttisch	Table de nuit	Bedside table	48/40/35

				Dimension cm
Ciara 28/3S	Rahmen Breiten Längen	Cadre Largeurs Longueurs	Frame Widths Lengths	140, 160, 180, 200 200, 210, 220
Fasio bronze	Füße Höhe	Pieds Hauteur	Feet Height	20
Damo	Kopfteil	Tête de lit	Headboard	140, 160, 180, 200

Alle Polsterteile in Rinovo taupe 701 | Toutes les parties rembourrées en Rinovo taupe 701 | All upholstery parts in Rinovo taupe 701
Alle Holzteile in Buche weiss lasiert, lackiert | Toutes les parties en bois en hêtre teinté blanc lasuré, lqué | All wooden parts in beech white stained, lacquered
Weitere Beimöbel siehe Register 2 | Autres accessoires voir registre 2 | Further accessories see index 2

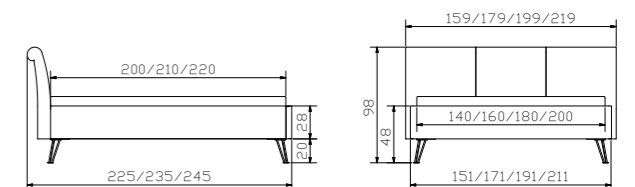



				Dimension cm
Aska	Sekretär	Secrétaire	Bureau	120/60/85
Trigo	Nachttisch	Table de nuit	Bedside table	48/43/55

				Dimension cm
Ciara 28/4S	Rahmen Breiten Längen	Cadre Largeurs Longueurs	Frame Widths Lengths	140, 160, 180, 200 200, 210, 220
Masi	Füße Höhen	Pieds Hauteurs	Feet Heights	10, 20, 25
Obag	Kopfteil	Tête de lit	Headboard	140, 160, 180, 200

Alle Polsterteile in Campos blanc 372 | Toutes les parties rembourrées en Campos blanc 372 | All upholstery parts in Campos blanc 372

Alle Holzteile in Nussbaum, geölt | Toutes les parties en bois en noyer, huilé | All wooden parts in walnut, oiled

Weitere Beimöbel siehe Register 2 | Autres accessoires voir registre 2 | Further accessories see index 2

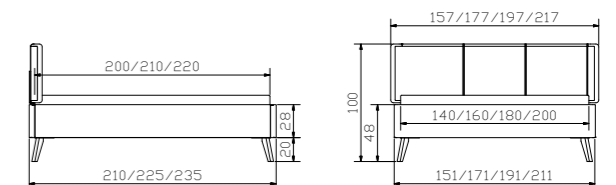



				Dimension cm
Cessina	Kommode	Commode	Chest of drawers	105/48/77
Turina	Nachttisch	Table de nuit	Bedside table	50/42/57

				Dimension cm
Lungo 28/3S	Rahmen Breiten Längen	Cadre Largeurs Longueurs	Frame Widths Lengths	140, 160, 180, 200 200, 210, 220
Skid	Kufen Breiten Höhe	Patins Largeurs Hauteur	Vats Widths Height	140, 160, 180, 200 25
Zuro	Kopfteil	Tête de lit	Headboard	140, 160, 180, 200

Alle Polsterteile in Boucle ivory 770 | Toutes les parties rembourrées en Boucle ivory 770 | All upholstery parts in Boucle ivory 770

Alle Holzteile in Wildeiche natur, gebürstet, geölt | Toutes les parties en bois en Chêne naturel, brossé, huilé | All wooden parts in Wildoak natural, brushed, oiled

Weitere Beimöbel siehe Register 2 | Autres accessoires voir registre 2 | Further accessories see index 2

