



swiss bed concept



OAKLINE

EICHE MASSIV | CHÊNE MASSIF | SOLID OAK

Achten Sie auf FSC®-zertifizierte Produkte | Soyez attentifs aux produits certifiés FSC® | Look for FSC®-certified products

Bettrahmen | Cadre de lit | Bedframe

Modul 18

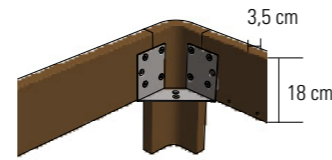

Breiten | Largeurs | Widths:
90, 100, 120, 140, 160, 180, 200 cm

Längen | Longueurs | Lengths:
190, 200, 210, 220 cm

Einlegetiefe | Hauteur encastrable | Insertion depth:
18 cm

Traversen | Traverses | Bars

Wir empfehlen grundsätzlich den Einsatz von Crosstraver (Quertraverse) oder Midtraver (Längstraverse).
Nous recommandons en général l'utilisation de Crosstraver (traverse transversale) ou Midtraver (traverse centrale).
We recommend basically the insertion of Crosstraver (central cross bar) or Midtraver (central bar).

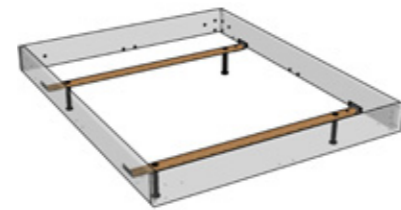
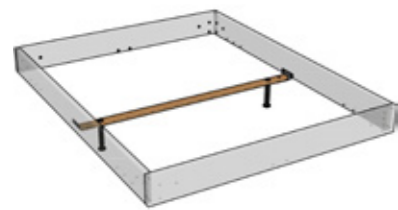

Crosstraver
Quertraverse | Traverse transversale | Central cross bar

Für alle Bettbreiten | Pour toutes les largeurs de lit | For all bed widths

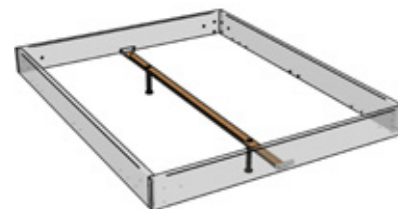

Crosstraver-Twin
Quertraversen | Traverses transversales | Cross bars

Für alle Bettbreiten | Pour toutes les largeurs de lit | For all bed widths

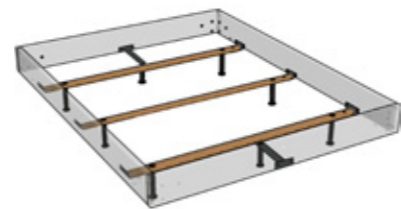

Crosstraver-XXL
Quertraversen | Traverses transversales | Cross bars

Für alle Bettbreiten | Pour toutes les largeurs de lit | For all bed widths

Midtraver
Längstraverse | Traverse centrale | Central bar

Für Betten ab Breite 140 cm mit 2 Lattenrosten oder Motorrahmen-einbau | Pour les lits à partir de 140 cm de largeur avec 2 sommiers ou l'installation d'un cadre motorisé | For beds from 140 cm width with 2 slats or motor frame installation

Übersicht Kompatibilität Traversen siehe Seite 2.12 | Aperçu compatibilité traverses voir page 2.12 | Overview compatibility bars see page 2.12

Ausführungen | Exécutions | Executions

Holz | Bois | Wood



86 Eiche natur, gebürstet, geölt
Chêne naturel, brossé, huilé
Oak natural, brushed, oiled

89 Eiche graphit, gebürstet, geölt
Chêne graphit, brossé, huilé
Oak graphit, brushed, oiled

91 Eiche cognac, gebürstet, geölt
Chêne cognac, brossé, huilé
Oak cognac, brushed, oiled

Füsse | Pieds | Feet

Airo



Cora



Eviron



Corno



Masito



Noro



Ronda



Tonna



Xylo



Acito



Sico



Slitto

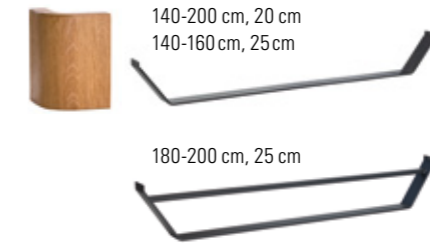

Cielo-Ron [▲]Baldachin/Baldaqin/Canopy



Lovie-Ron Box
90-140 (1 Schublade/Tiroir/Drawer)
140-200 (2 Schubladen/Tiroirs/Drawers)



Holz | Bois | Wood

	Breiten cm Largeurs cm Widths cm	Höhen cm Hauteurs cm Heights cm			Holzfarben Couleurs bois Colours wood				
		20	25	30	10	16	86	89	91
Airo	90-200	●	●	●	●	●	●	●	●
Cora	90-200	●	●	●	●	●	●	●	●
Corno		●	●	●	●	●	●	●	●
Eviron	90-200	●	●	●	●	●	●	●	●
Lovie-Ron Box (1 Schublade/Tiroir/Drawer)	90-140	●	●	●	●	●	●	●	●
Lovie-Ron Box (2 Schubladen/Tiroirs/Drawers)	140-200	●	●	●	●	●	●	●	●
Masito		●	●	●	●	●	●	●	●
Noro		●	●	●	●	●	●	●	●
Practico-Ron Box*	90-200	●	●	●	●	●	●	●	●
Ronda		●	●	●	●	●	●	●	●
Tonna		●	●	●	●	●	●	●	●
Xylo		●	●	●	●	●	●	●	●

Metall | Métal | Metal

	Breiten cm Largeurs cm Widths cm	Höhen cm Hauteurs cm Heights cm			Metallfarben Couleurs métal Colours metal			
		20	25	30	10	16	42	43
Acito		●	●	●	●	●	●	●
Cielo-Ron [▲]	120-200	●	●	●	●	●	●	●
Sico		●	●	●	●	●	●	●
Slitto	140-200	●	●	●	●	●	●	●

[▲] **Curty Vorhang und Vela Baldachin-Tuch siehe Register 2, Seite 2.7** | Curty rideau et Vela tissu de baldaquin voir registre 2, page 2.7 | Curty curtain and Vela canopy cloth see index 2, page 2.7

Eckfüsse/Eckteile + Füße (inkl. Beschläge) | Pieds d'angles/Pièces d'angles + Pieds (Visserie incl.) | Corner feet, Corner pieces + Feet (Fittings included)

*weiss/anthrazit = MDF
*blanc/anthracite = MDF
*white/anthracite = MDF

Metall | Métal | Metal



10 Weiss | Blanc | White **16 Anthracit** **42 Alu** **43 Inox**

Bettkasten mit Holzkufe | Tiroirs de lit avec patins en bois | Bed drawers with wooden vat



Lovie-Ron Box + Covero
90-140 cm 1 Schublade | 1 Tiroir | 1 Drawer

Stauraum | Compartiment de rangement | Storage space:
134 × 61 × 16 cm

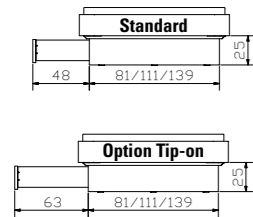

Standard: gedämpfter Selbsteinzug Blumotion von BLUM
Option: Tip-on-Öffnung mit Vollauszug von BLUM

Roll-Box 20/25



Bettkasten in weiss oder anthrazit (Boden weiss)

Voraussetzung
Bettfusshöhe von mindestens 20cm erforderlich

Optionen
Deckel Covero in weiss, Stoffabdeckung Saceto in Polyester grau.

Lovie-Ron Box + Saceto
140-200 cm 2 Schubladen | 2 Tiroirs | 2 Drawers

Stauraum | Compartiment de rangement | Storage space:
2 × 134 × 61 × 16 cm

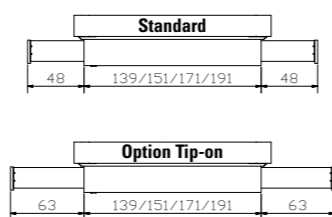

Standard: système d'amortissement Blumotion de BLUM
Option: ouverture Tip-on avec sortie totale de BLUM

Roll-Box 20/25 + Covero



Tiroir de lit en blanc ou anthracite (fond blanc)

Condition préalable
Une hauteur de pieds de lit d'au moins 20 cm est nécessaire

Options
Couvercle Covero en blanc, tissu de protection Saceto en polyester gris.

Roll-Box 20/25 + Saceto



Bed drawer in white or anthracite (bottom white)

Condition
Feet of bed need a minimum height of 20 cm

Options
Covero in white, tissue of protection Saceto in polyester grey.

Stauraum | Espace de rangement | Storage space

Roll-Box 20	=	134 × 61 × 13 cm
Roll-Box 25	=	134 × 61 × 16 cm

Roll-Box 20

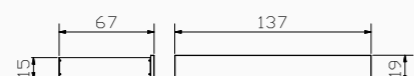

Roll-Box 25

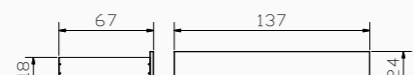

Bettkasten | Coffres à literie | Bedding boxes

Practico-Ron Box + Modul 18 + Ultrafree-Lift KF



Ultrafree-Lift KF



Box = inkl. Boden, Anwendung siehe Seiten 10.14–10.15
zu Practico-Ron Box:
Lattenrost **Ultrafree-Lift KF**
Kopf-/Fussverstellung
Rahmenholme Höhe 7 cm und 28 Federleisten aus Buchenschichtholz
Gesamthöhe 11 cm

Lattenrost **Econom-move**
Unverstellbar
Rahmenholme Höhe 6 cm und 28 Federleisten aus Buchenschichtholz
Gesamthöhe 9 cm

inkl. Gasdruckfedern und allen Beschlägen

Details zu Ultrafree-Lift KF und Econom-move siehe Register 14, Seite 14.8

Practico-Ron Box + Modul 18 + Econom-move



Econom-move



Box = fond inclus, utilisation voir pages 10.14–10.15
pour box Practico-Ron:
Sommier **Ultrafree-Lift KF**
Tête et pied réglables
Cadre, hauteur 7 cm et 28 lattes en hêtre multiplis
Hauteur totale 11 cm

Sommier **Econom-move**
Non réglable
Cadre, hauteur 6 cm et 28 lattes en hêtre multiplis
Hauteur totale 9 cm

Pistons à gaz et toute la quincaillerie inclus

Détails pour Ultrafree-Lift KF et Econom-move voir registre 14, page 14.8

Stauraum | Compartiment de rangement | Storage space

90 × 200/210/220	=	81 × 190/200/210 × 24 cm
100 × 200/210/220	=	91 × 190/200/210 × 24 cm
120 × 200/210/220	=	111 × 190/200/210 × 24 cm
140 × 200/210/220	=	131 × 190/200/210 × 24 cm
160 × 200/210/220	=	74 × 190/200/210 × 24 (2 x) cm
180 × 200/210/220	=	84 × 190/200/210 × 24 (2 x) cm
200 × 200/210/220	=	94 × 190/200/210 × 24 (2 x) cm

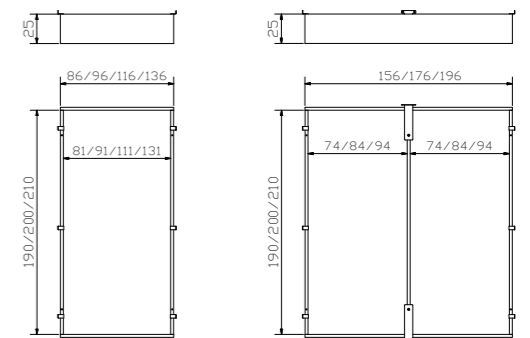

Box = bottom incl., handling see pages 10.14–10.15
for Practico-Ron box:
Slats **Ultrafree-Lift KF**
Head/footpiece adjustable
Frame, height 7 cm and 28 slats are of beech veneer board
Total height 11 cm

Slats **Econom-move**
Not adjustable
Frame, height 6 cm and 28 slats are of beech veneer board
Total height 9 cm

Pneumatic compression spring and all fittings included

Details for Ultrafree-Lift KF and Econom-move see index 14, pages 14.8

Himmelbett ohne Grenzen

Lit à baldachin sans frontières | Canopy bed without borders



Betrahmen
Cadre de lit | Bedframe

Cielo
Baldachin | Baldachin | Canopy

Kopfteil
Tête de lit | Headboard



Kopfteile | Têtes de lit | Headboards

Alpa

Dimension: 140, 160, 180, 200

Lisio

Dimension: 90/100, 120, 140, 160, 180, 200

Soleo

Dimension: 140, 160, 180, 200

Varus

Dimension: 90/100, 120, 140, 160, 180, 200

gepolstert | rembourrées | upholstered

Cemoa

Dimension: 90, 100, 120, 140, 160, 180, 200 (90-120 = 1 Kissen | Coussin | Cushion)

Gewünschte Liegefläche (Länge) = zu bestellende Bettrahmenlänge
 Surface de couchage souhaitée (Longueur) = longueur de cadre de lit à commander
 Desired mattress lying area (Length) = length of bedframe to be ordered
190 = 200
200 = 210
210 = 220

Nur montierbar mit runden Ecken. | Montage uniquement possible avec des angles ronds. | Can only be assembled with round edges. (Füsse | Pieds | Feet: Airo, Eviron, Masito, Practico-Ron Box, Ronda, Slitto, Tonna, Xylo, Cielo-Ron, Lovie-Ron Box).

Das Kopfteil Cemoa enthält in Echtleder keine Teilungsnähte.
 En cuir véritable, la tête de lit Cemoa ne comporte pas de coutures de séparation.
 The Cemoa headboard contains no dividing seams in genuine leather.

Adapter | Adaptateur | Adapter

Bei hohen Matratzen kann mit dem Verlängerungsadapter das Kopfteil um 9 oder 13 cm erhöht werden.
 La tête de lit peut être rehaussée de 9 ou 13 cm avec l'adaptateur lorsque le matelas est plus épais.
 With the extension adapter the headboard can be extended 9 or 13 cm if mattresses are high.

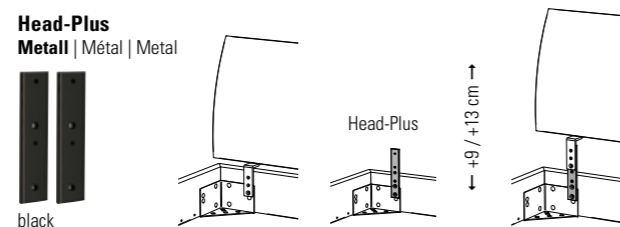

Kissen zu Kopfteilen | Coussins pour têtes de lit | Cushions for headboards

Arona + Alpa

Lumo + Alpa

Ravo + Varus

Sano + Alpa

Suny + Varus

Varo + Varus

Befestigung mit 2 Bändern (Klettverschluss)
 Fixation avec 2 bandes Velcro®
 Fixation with 2 ribbons (Velcro® fastener)

Kissen Coussins Cushions	Effektive Masse cm Dimensions effectives cm Effective dimensions cm	zu Kopfteilen pour têtes de lit for headboards		Breitenmasse cm Dimensions de largeur cm Widths dimensions cm
		Alpa	Varus	
Arona	86, 116, 136, 156, 176×3,5×25	●		140, 160, 180/200
Lumo	86, 116, 136, 156, 176×6×25	●		140, 160, 180/200
Ravo	80, 110, 130, 150, 170, 190×3,5×35	●	●	90/100, 120, 140, 160, 180, 200
Sano (2er Set set de 2 set of 2)	55×4×35	●		
Suny (2er Set set de 2 set of 2)	55×6×40	●	●	
Varo (2er Set set de 2 set of 2)	55×10×35		●	

Alle Kissen in Echtleder haben Zier- sowie Teilungsnähte. Ausnahmen: Ravo, Suny und Varo, diese Kissen haben lediglich Ziernähte. | Tous les coussins en cuir véritable ont des coutures décoratives et des coutures de séparation. A l'exception des coussins : Ravo, Suny et Varo, ces coussins ont uniquement des coutures décoratives. | All cushions in genuine leather have decorative and dividing seams. Exceptions: Ravo, Suny and Varo, these cushions only have decorative seams.

Ausführungen | Exécutions | Executions

Holz | Bois | Wood

86
Eiche natur, gebürstet, geölt
Chêne naturel, brossé, huilé
Oak natural, brushed, oiled

89
Eiche graphit, gebürstet, geölt
Chêne graphit, brossé, huilé
Oak graphit, brushed, oiled

91
Eiche cognac, gebürstet, geölt
Chêne cognac, brossé, huilé
Oak cognac, brushed, oiled

Nachttische, Kommoden | Tables de nuit, commodes | Bedside tables, chests of drawers



Beimöbel | Accessoires | Accessories

Bank + Kissen | Banquette + Coussin | Bench + Cushion

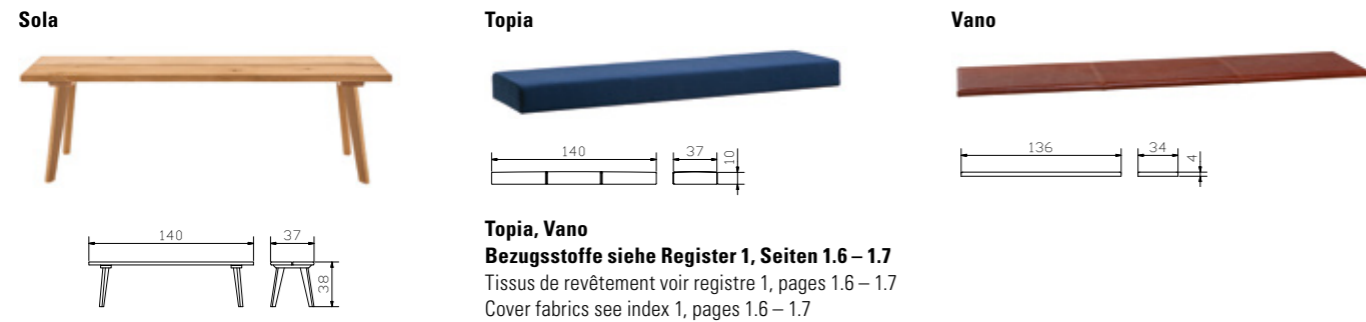

Herrendiener | Valet | Dressboy

Claudio alu, anthracit, iron

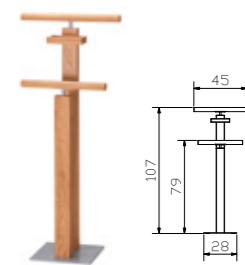

Sekretär | Secrétaire | Bureau

Aska



Ausführungen | Exécutions | Executions

Holz | Bois | Wood



86
Eiche natur, gebürstet, geölt
Chêne naturel, brossé, huilé
Oak natural, brushed, oiled



89
Eiche graphit, gebürstet, geölt
Chêne graphit, brossé, huilé
Oak graphit, brushed, oiled



91
Eiche cognac, gebürstet, geölt
Chêne cognac, brossé, huilé
Oak cognac, brushed, oiled

Metall | Métal | Metal



16
Anthracit



42
Alu

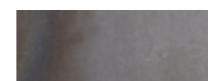

45
Iron

16 Anthracit = Stahl pulverbeschichtet | Acier thermolaqué | Steel powder-coated
42 Alu = Stahl pulverbeschichtet | Acier thermolaqué | Steel powder-coated
45 Iron = Stahl geflammt, pulverbeschichtet | Acier flammé, thermolaqué | Steel mottled, powder-coated



selezione

01

MODELLAUSWAHL

Sélection du modèle | Model selection

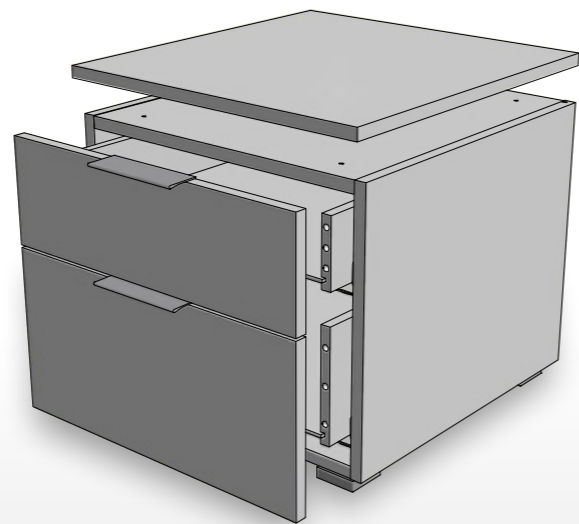

02

KORPUS

Caisson | Body



03

TOP/FRONT

Farben | Couleurs | Colours



04

GRIFFE

Poignées | Handles



Stellen Sie sich Ihr Wunsch-Beimöbel nach Ihrem Geschmack zusammen: Der Korpus (Abb. 02), in zwei verschiedenen Farbvarianten, lässt sich zu den Front- und Top-Covern (Abb. 03) in acht Holz- und Farbausführungen kombinieren. Die Beimöbel können zerlegt oder teilmontiert bestellt werden. Bei zusammengesetzten Möbeln (z. B. Qunito, Incentro, ...) muss der Deckel noch montiert werden. Bei Kommoden mit Türen ist jeweils ein Einlegeboden vorhanden, Türöffnung nach links oder rechts möglich. Zusätzliche Böden sind erhältlich.

Composez le meuble d'appoint de vos rêves selon vos goûts : Le caisson (ill. 02), disponible en 2 variantes de couleurs, peut être combiné avec les façades et couvercles supérieurs (ill. 03) en 8 finitions de bois et de coloris. Les meubles d'appoint peuvent être commandés en kits ou assemblés. Pour les meubles assemblés (p. ex. Qunito, Incentro, ...) le couvercle doit encore être fixé. Les commodes avec portes sont équipées d'une étagère, ouverture de la porte possible à gauche ou à droite. Si besoin, des étagères supplémentaires sont disponibles.

Put together the side furniture you want according to your own taste: The body (fig. 02), in two different colour versions, can be combined with the front and top covers (fig. 03) in eight wood and colour versions. The furniture can be ordered disassembled or assembled. For assembled furniture (e.g. Qunito, Incentro, ...) the top cover must still be fitted. Chests of drawers with doors have one shelf, door opening possible to the left or right. Additional shelves are available.



Kombinationsbeispiele und techn. Informationen
Exemples et informations
Examples and informations

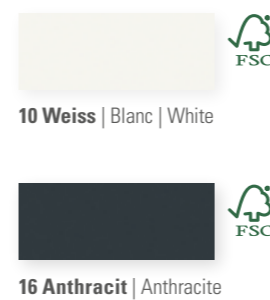

STANDARD



OPTION

Leg 8 cm Jone 10 cm Cila 10 cm

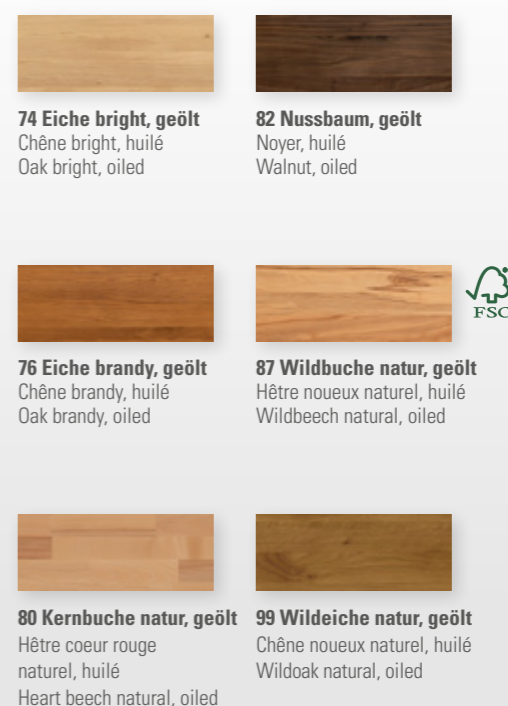
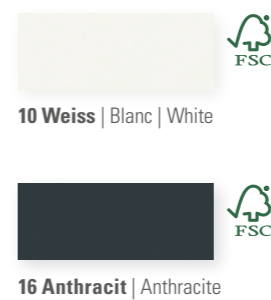

STANDARD



Alu
Griff zu Folienfronten
Poignée pour façades en mélaminé
Handle for foil fronts

STANDARD



Holzgriff zu Holzfronten
Poignée en bois pour façades en bois
Wooden handle for wooden fronts

OPTION

Rivo

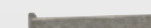

Used



Anthracit

Metallgriff zu Holzfronten

Poignée en métal pour façades en bois
Metal handle for wooden fronts



Lattenroste | Sommier | Slats



Dritto U

U = Unverstellbar
Non réglable
Not adjustable

Rahmenholme und 14 Federleisten aus Buchenschichtholz
Cadre et 14 lattes en hêtre multiplis
Frame and 14 slats are of beech veneer board

Starre Lagerung
Suspension rigide
Rigid suspension

Längen | Longueurs | Lengths

190
200

Breiten | Largeurs | Widths

80	90	100	120	140
	●			●
●	●	●	●	●

Höhe | Hauteur | Height: 6 cm

Keine Sondermasse möglich | Dimensions spéciales non disponibles |
No special sizes possible



Flexo K

K = Kopfteil manuell 13-fach verstellbar
Réglage manuel de la tête en 13 positions
Head piece manually adjustable in 13 positions

Rahmenholme und 28 Federleisten aus Buchenschichtholz
Cadre et 28 lattes en hêtre multiplis
Frame and 28 slats are of beech veneer board

Flexible Lagerung
Suspension flexible
Flexible suspension

Schulterkomfortzone
Zone de confort des épaules
Comfort zone for shoulders

Mittelzonenverstärkung
Zone médiane renforcée
Reinforcement of the middle zone



Längen | Longueurs | Lengths

190
200, 210, 220

Breiten | Largeurs | Widths

80	90	100	120	140
	●			●
●	●	●	●	●

Höhe | Hauteur | Height: 9 cm

Keine Sondermasse möglich | Dimensions spéciales non disponibles |
No special sizes possible



Ultrafree RF

RF = Rücken- und Fussteil manuell je 13-fach verstellbar
Réglage manuel pour le haut du corps et les jambes en 13 positions
Back and foot sections manually adjustable in 13 positions

Rahmenholme und 30 Federleisten aus Buchenschichtholz
Cadre et 30 lattes en hêtre multiplis
Frame and 30 slats are of beech veneer board

Details siehe Seite 13.2–13.3
Détails voir page
Details see page:

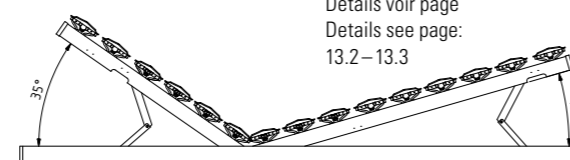

Längen | Longueurs | Lengths

190
200, 210, 220

Breiten | Largeurs | Widths

80	90	100	120	140
●	●	●	●	●
●	●	●	●	●

Höhe | Hauteur | Height: 10 cm

Keine Sondermasse möglich | Dimensions spéciales non disponibles |
No special sizes possible

Matratzen | Matelas | Mattresses

Novo

7-Zonen-Kaltschaumkern, Höhe 8 cm in Härtegrad H3 (RG 35) erhältlich
7-zones noyau en mousse froide, hauteur 8 cm disponible dans le degré de fermeté f3 (densité 35)
7-zones core cold foam, height 8 cm available in the degree of hardness H3 (density 35)

Optimale Unterstützung durch 7-Zonen-Kaltschaum-Noppenprofil in 2.5 cm Stärke
Soutien optimal grâce à une mousse 7-zones froide à picots 2.5 cm
Optimum support through 7-zones cold foam upholstery 2.5 cm with nobs

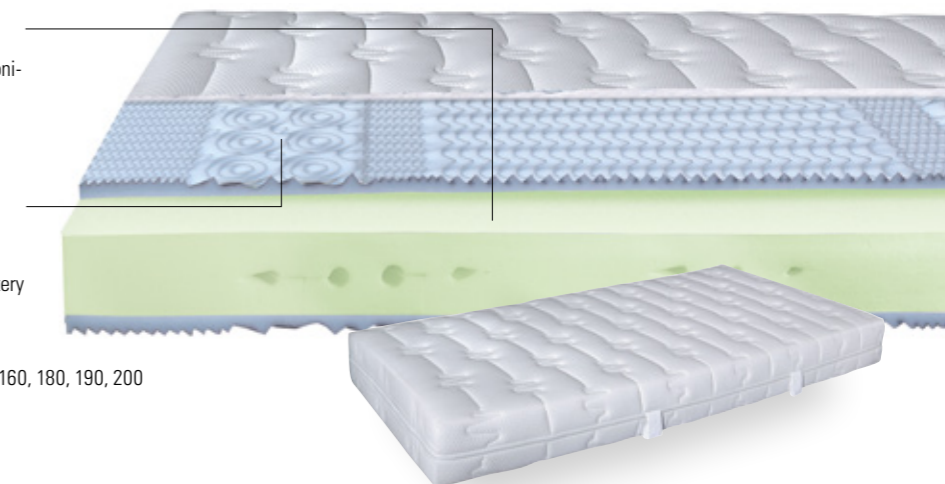

Breiten | Largeurs | Widths 80, 90, 100, 120, 140, 160, 180, 190, 200 cm

Längen | Longueurs | Lengths 200, 210, 220 cm

Höhe | Hauteur | Height 16 cm

Ultraconfort

7-Zonen-Kaltschaumkern, Höhe 12 cm in den Härtegraden H3 (RG 45) und H4 (RG 50) erhältlich
7-zones noyau en mousse froide, hauteur 12 cm disponible dans les degrés de fermeté f3 (densité 45) et f4 (densité 50)
7-zones core cold foam, height 12 cm available in the degrees of hardness H3 (density 45) and H4 (density 50)

Optimale Unterstützung und Klimatisierung durch 4 cm Soft-Kaltschaum-Auflage RG 60
Soutien optimal et climatisation idéale grâce à une mousse froide souple 4 cm densité 60
Optimum support and climate regulation through 4 cm soft cold foam upholstery density 60

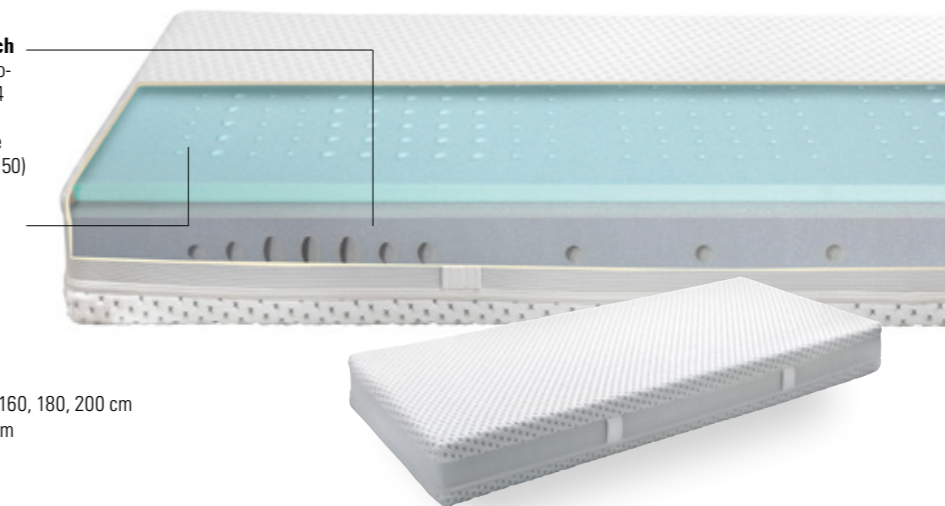

Breiten | Largeurs | Widths 80, 90, 100, 120, 140, 160, 180, 200 cm

Längen | Longueurs | Lengths 190, 200, 210, 220 cm

Höhe | Hauteur | Height 21 cm

Ultramotion

7-Zonen-Kaltschaum-Tröpfchenkern mit Querbelüftung und Schulterzone, Höhe 20 cm in den Härtegraden H2 (RG 53), H3 (RG 53) und H4 (RG 45) erhältlich

7-zones noyau de gouttelettes en mousse froide avec ventilation transversale et zone pour les épaules, hauteur 20 cm disponible dans les degrés de fermeté f2 (densité 53), f3 (densité 53) et f4 (densité 45)
7-zones cold foam droplet core with lateral ventilation and shoulder zone, height 20 cm available in the degrees of hardness H2 (density 53), H3 (density 53) and H4 (density 45)



Breiten | Largeurs | Widths 80, 90, 100, 120, 140, 160, 180, 200 cm

Längen | Longueurs | Lengths 190, 200, 210, 220 cm

Höhe | Hauteur | Height 23 cm

Informationen zu Matratzenbezügen und weitere Lattenroste und Matratzen siehe Register 13

Informations sur les housses de matelas et autres sommiers et matelas, voir registre 13
Information on mattress covers and other slatted frames and mattresses, see tab 13.



				Dimension cm
Sola	Bank	Banquette	Bench	140/37/38
Topia	Kissen, Kitana anthrazit 604	Coussin, Kitana anthrazit 604	Cushion, Kitana anthrazit 604	140/37/10
Aska	Sekretär	Secrétaire	Bureau	120/60/85
Koro	Nachttisch	Table de nuit	Bedside table	50/40/57

				Dimension cm
Modul 18	Rahmen Breiten Längen	Cadre Largeurs Longueurs	Frame Widths Lengths	90, 100, 120, 140, 160, 180, 200 190, 200, 210, 220
Practico-Ron Box	Anthrazit Breiten Längen Höhe	Anthracite Largeurs Longueurs Hauteur	Anthracite Widths Lengths Height	90, 100, 120, 140, 160, 180, 200 200, 210, 220 25
Varus	Kopfteil	Tête de lit	Headboard	90/100, 120, 140, 160, 180, 200
Ravo	Kissen, Kitana anthrazit 604	Coussin, Kitana anthrazit 604	Cushion, Kitana anthrazit 604	90/100, 120, 140, 160, 180, 200



Details siehe Seite 10.5
Détails voir page 10.5
Details see page 10.5

Alle Holzteile in Eiche cognac, gebürstet, geölt oder anthrazit
Toutes les parties en bois en chêne cognac, brossé, huilé ou anthracite
All wooden parts in oak cognac, brushed, oiled or anthracite

Weitere Beimöbel siehe Register 2
Autres accessoires voir registre 2
Further accessories see index 2

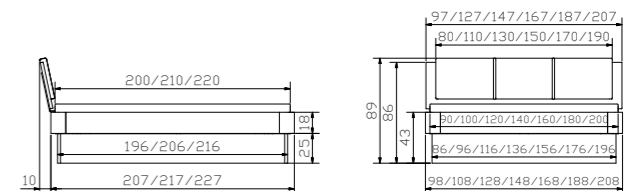



				Dimension cm
Claudio alu	Herrendiener	Valet	Dressboy	45/28/107
Cara	Nachttisch	Table de nuit	Bedside table	50/40/40

				Dimension cm
Modul 18	Rahmen Breiten Längen	Cadre Largeurs Longueurs	Frame Widths Lengths	90, 100, 120, 140, 160, 180, 200 190, 200, 210, 220
Ronda	Eckfüsse Höhen	Pieds d'angles Hauteurs	Corner feet Heights	20(38), 25(43), 30(48)
Lisio	Kopfteil	Tête de lit	Headboard	90/100, 120, 140, 160, 180, 200

Alle Holzteile in Eiche cognac, gebürstet, geölt | Toutes les parties en bois en chêne cognac, brossé, huilé | All wooden parts in oak cognac, brushed, oiled
Weitere Beimöbel siehe Register 2 | Autres accessoires voir registre 2 | Further accessories see index 2

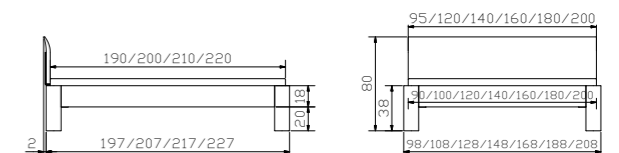



Dimension cm

Modul 18	Rahmen Breiten Längen	Cadre Largeurs Longueurs	Frame Widths Lengths	90, 100, 120, 140, 160, 180, 200 190, 200, 210, 220
Xylo	Eckfüsse Höhen	Pieds d'angles Hauteurs	Corner feet Heights	20(38), 25(43), 30(48)
Gabo	Kopfteil, Campos blanc 372 siehe Register 1	Tête de lit, Campos blanc 372 voir registre 1	Headboard, Campos blanc 372 see index 1	90, 100, 120, 140, 160, 180, 200

Dimension cm

Modul 18	Rahmen Breiten Längen	Cadre Largeurs Longueurs	Frame Widths Lengths	90, 100, 120, 140, 160, 180, 200 190, 200, 210, 220
Xylo	Eckfüsse Höhen	Pieds d'angles Hauteurs	Corner feet Heights	20(38), 25(43), 30(48)
Lisio	Kopfteil	Tête de lit	Headboard	90/100, 120, 140, 160, 180, 200
Koro	Nachttisch	Table de nuit	Bedside table	50/40/57

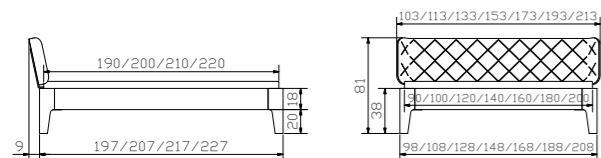

Alle Holzteile in Eiche natur, gebürstet, geölt
 Toutes les parties en bois en chêne naturel, brossé, huilé
 All wooden parts in oak natural, brushed, oiled
Weitere Beimöbel siehe Register 2
 Autres accessoires voir registre 2
 Further accessories see index 2

Alle Holzteile in Eiche cognac, gebürstet, geölt
 Toutes les parties en bois en chêne cognac, brossé, huilé
 All wooden parts in oak cognac, brushed, oiled
Weitere Beimöbel siehe Register 2
 Autres accessoires voir registre 2
 Further accessories see index 2

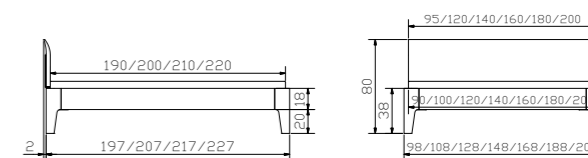



Dimension cm

Totrino	Kommode	Commode	Chest of drawers	135/50/86
Twia	Nachttisch	Table de nuit	Bedside table	45/50/41
Sola	Bank	Table de nuit	Bedside table	140/37/38
Vano	Kissen, Campos blanc 372	Coussin, Campos blanc 372	Cushion, Campos blanc 372	136/34/3

Dimension cm

Modul 18	Rahmen Breiten Längen	Cadre Largeurs Longueurs	Frame Widths Lengths	140, 160, 180, 200 190, 200, 210, 220
Masito	Füße, Eckteile Höhen	Pieds, Pièces d'angles Hauteurs	Feet, Corner pieces Heights	20, 25
Soleo	Kopfteil	Tête de lit	Headboard	140, 160, 180, 200

Alle Holzteile in Eiche cognac, gebürstet, geölt und weiss | Toutes les parties en bois en chêne cognac, brossé, huilé et blanc | All wooden parts in oak cognac, brushed, oiled and white
Weitere Beimöbel siehe Register 2 | Autres accessoires voir registre 2 | Further accessories see index 2

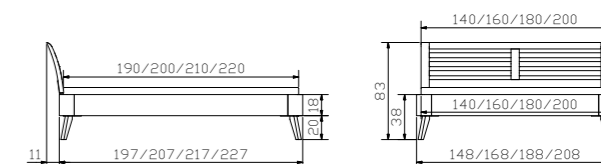



	Dimension cm			
Lovie-Ron Box	1 Bettkasten Breiten 2 Bettkästen Breiten Höhe	1 Tiroir de lit Largeurs 2 Tiroirs de lit Largeurs Hauteur	1 Bed drawer Widths 2 Bed drawers Widths Height	90, 100, 120, 140 140, 160, 180, 200 25
Aida	Kommode	Commode	Chest of drawers	105/40/75
Caja	Nachttisch	Table de nuit	Bedside table	48/41/16

	Dimension cm			
Modul 18	Rahmen Breiten Längen	Cadre Largeurs Longueurs	Frame Widths Lengths	90, 100, 120, 140, 160, 180, 200 190(200), 200(210), 210(220)
Cemoa	Kopfteil, Campos cafe 374 hat Einfluss auf Bettlänge siehe Seite 10.6	Tête de lit, Campos cafe 374 a un impact sur la longueur du lit voir page 10.6	Headboard, Campos cafe 374 affects the length of bed see 10.6	90, 100, 120, 140, 160, 180, 200 90 – 120 = 1 Kissen/Coussin/ Cushion

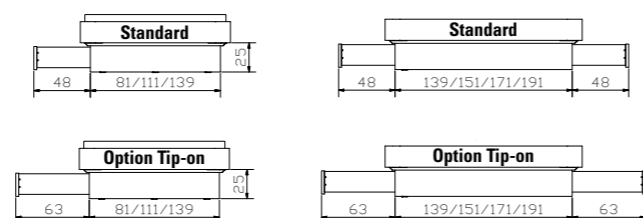

Alle Holzteile in Eiche natur, gebürstet, geölt
Toutes les parties en bois en chêne naturel, brossé, huilé
All wooden parts in oak natural, brushed, oiled

Weitere Beimöbel siehe Register 2
Autres accessoires voir registre 2
Further accessories see index 2

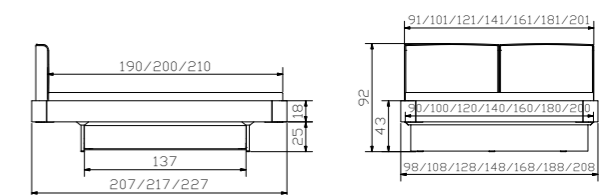



				Dimension cm
Cemoa	Kopfteil, Fusio shell 750 hat Einfluss auf Bettlänge siehe Seite 10.6	Tête de lit, Fusio shell 750 a un impact sur la longueur du lit voir page 10.6	Headboard, Fusio shell 750 affects the length of bed see 10.6	90, 100, 120, 140, 160, 180, 200 90 – 120 = 1 Kissen/Coussin/ Cushion
Boga	Kopfteil, Fusio shell 750 siehe Register 1	Tête de lit, Fusio shell 750 voir registre 1	Headboard, Fusio shell 750 see index 1	90, 100, 120, 140, 160, 180, 200

				Dimension cm
Modul 18	Rahmen Breiten Längen	Cadre Largeurs Longueurs	Frame Widths Lengths	90, 100, 120, 140, 160, 180, 200 190(200), 200(210), 210(220)
Slitto white	Kufen, Eckteile Breiten Höhen	Patins, Pièces d'angles Largeurs Hauteurs	Vats, Corner pieces Widths Heights	140, 160, 180, 200 20, 25
Cemoa	Kopfteil, Campos blanc 372 hat Einfluss auf Bettlänge siehe Seite 10.6	Tête de lit, Campos blanc 372 a un impact sur la longueur du lit voir page 10.6	Headboard, Campos blanc 372 affects the length of bed see 10.6	90, 100, 120, 140, 160, 180, 200 90 – 120 = 1 Kissen/Coussin/ Cushion
Aida	Kommode	Commode	Chest of drawers	105/40/75
Cara	Nachttisch	Table de nuit	Bedside table	50/40/40

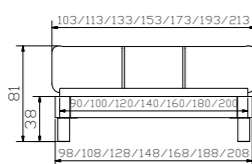
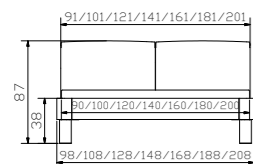

Alle Holzteile in Eiche natur, gebürstet, geölt
Toutes les parties en bois en chêne naturel, brossé, huilé
All wooden parts in oak natural, brushed, oiled

Weitere Beimöbel siehe Register 2
Autres accessoires voir registre 2
Further accessories see index 2

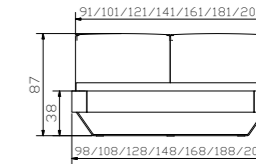
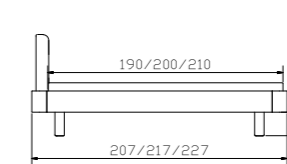



Dimension cm

Sola	Bank	Banquette	Bench	140/37/38
Topia	Kissen, Campos blanc 372	Coussin, Campos blanc 372	Cushion, Campos blanc 372	140/37/10
Cara	Nachttisch	Table de nuit	Bedside table	50/40/40
Vela	Baldachin-Tuch, Baumwolle weiss	Tissu de baldaquin, Coton blanc	Canopy cloth, Cotton white	
	Breiten	Largeurs	Widths	120, 140, 160, 180, 200
	Länge	Longueur	Length	200
Curty	Baldachin-Vorhang (3er Set)	Rideau de baldaquin (set de 3)	Curtain of canopy (set of 3)	272/185 (3x)
	Baumwolle weiss	Coton blanc	Cotton white	

Dimension cm

Modul 18	Rahmen	Cadre	Frame	
	Breiten	Largeurs	Widths	120, 140, 160, 180, 200
	Längen	Longueurs	Lengths	190, 200, 210, 220
Cielo-Ron white	Baldachin	Baldaquin	Canopy	
	Breiten	Largeurs	Widths	120, 140, 160, 180, 200
	Längen	Longueurs	Lengths	200, 210, 220
	Höhe	Hauteur	Height	20
Ripo	Kopfteil, Campos blanc 372	Tête de lit, Campos blanc 372	Headboard, Campos blanc 372	120, 140, 160, 180, 200

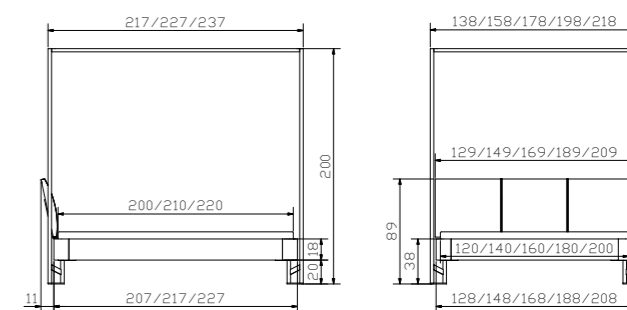

Alle Holzteile in Eiche natur, gebürstet, geölt
 Toutes les parties en bois en chêne naturel, brossé, huilé
 All wooden parts in oak natural, brushed, oiled

Weitere Beimöbel siehe Register 2
 Autres accessoires voir registre 2
 Further accessories see index 2



				Dimension cm
Talo	Nachttisch	Table de nuit	Bedside table	50/40/40

				Dimension cm
Modul 18	Rahmen Breiten Längen	Cadre Largeurs Longueurs	Frame Widths Lengths	90, 100, 120, 140, 160, 180, 200 190, 200, 210, 220
Ronda	Eckfüsse Höhen	Pieds d'angles Hauteurs	Corner feet Heights	20(38), 25(43), 30(48)
Lisio	Kopfteil	Tête de lit	Headboard	90/100, 120, 140, 160, 180, 200

Alle Holzteile in Eiche natur, gebürstet, geölt | Toutes les parties en bois en chêne naturel, brossé, huilé | All wooden parts in oak natural, brushed, oiled
Weitere Beimöbel siehe Register 2 | Autres accessoires voir registre 2 | Further accessories see index 2

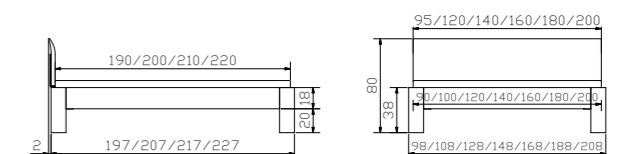



Lovie-Ron Box			
1 Bettkasten	1 Tiroir de lit	1 Bed drawer	Dimension cm
Breiten	Largeurs	Widths	90, 100, 120, 140
2 Bettkästen	2 Tiroirs de lit	2 Bed drawers	
Breiten	Largeurs	Widths	140, 160, 180, 200
Höhe	Hauteur	Height	25

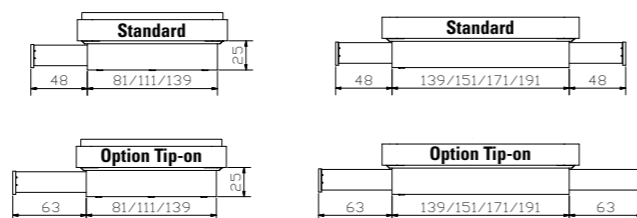

Modul 18			
Rahmen	Cadre	Frame	Dimension cm
Breiten	Largeurs	Widths	140, 160, 180, 200
Längen	Longueurs	Lengths	190, 200, 210, 220
Slitto anthracit	Kufen, Eckteile	Patins, Pièces d'angles	Vats, corner pieces
Breiten	Largeurs	Largeurs	Widths
Höhen	Höhen	Hauteurs	Heights
			140, 160, 180, 200
			20, 25
Cussina	Kopfteil, Fusio musk 752	Tête de lit, Fusio musk 752	Headboard, Fusio musk 752
	siehe Register 1	voir registre 1	see index 1
			140, 160, 180, 200
Topa anthracit	Bank inkl. Kissen	Banquette, Coussin incl.	Bench, cushion incl.
	Fusio musk 752	Fusio musk 752	Fusio musk 752
			144/44/38
Caja	Nachttisch	Table de nuit	Bedside table
			48/41/16

Alle Holzteile in Eiche graphit, gebürstet, geölt
 Toutes les parties en bois en chêne graphit, brossé, huilé
 All wooden parts in oak graphit, brushed, oiled

Weitere Beimöbel siehe Register 2
 Autres accessoires voir registre 2
 Further accessories see index 2

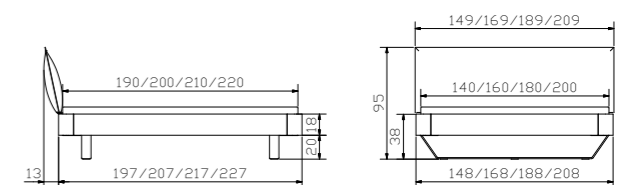



				Dimension cm
Caja	Nachttisch	Table de nuit	Bedside table	48/41/16
Atrine	Kommode	Commode	Chest of drawers	90/50/86
Snake alu	Leselampe (2er Set) 12V DC, 6 LED	Lampe de lecture (set de 2) 12V DC, 6 LED	Reading lamp (set of 2) 12V DC, 6 LED	

				Dimension cm
Modul 18	Rahmen Breiten Längen	Cadre Largeurs Longueurs	Frame Widths Lengths	90, 100, 120, 140, 160, 180, 200 190, 200, 210, 220
Corno	Eckfüsse Höhen	Pieds d'angles Hauteurs	Corner feet Heights	20(38), 25(43), 30(48)
Varus Varo	Kopfteil Kissen (2er Set) Rinovo taupe 701	Tête de lit Coussins (set de 2) Rinovo taupe 701	Headboard Cushions (set of 2) Rinovo taupe 701	90/100, 120, 140, 160, 180, 200 55/10/35

Alle Holzteile in Eiche graphit, gebürstet, geölt | Toutes les parties en bois en chêne graphit, brossé, huilé | All wooden parts in oak graphit, brushed, oiled
Lampen und weitere Beimöbel siehe Register 2 | Lampes et autres accessoires voir registre 2 | Lamps and further accessories see index 2

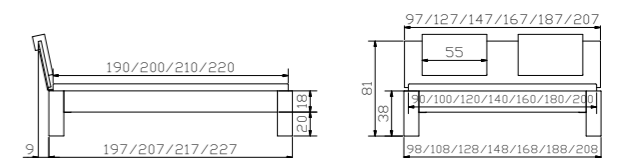



Dimension cm

Caja	Nachttisch	Table de nuit	Bedside table	48/41/16
Claudio alu	Herrendiener	Valet	Dressboy	45/28/107
Sola	Bank	Banquette	Bench	140/37/38
Topia	Kissen, Buffalo grey 721	Coussin, Buffalo grey 721	Cushion, Buffalo grey 721	140/37/10

Dimension cm

Modul 18	Rahmen Breiten Längen	Cadre Largeurs Longueurs	Frame Widths Lengths	90, 100, 120, 140, 160, 180, 200 190, 200, 210, 220
Noro	Füße, Eckteile Höhen	Pieds, Pièces d'angles Hauteurs	Feet, corner pieces Heights	20, 25, 30
Umbia L	Wandpaneel Buffalo grey 721 nur für Wandmontage siehe Register 1	Panneau mural Buffalo grey 721 uniquement pour montage mural voir registre 1	Wall panel Buffalo grey 721 wall assembly only see index 1	153, 173, 193, 213

Alle Holzteile in Eiche graphit, gebürstet, geölt | Toutes les parties en bois en chêne graphit, brossé, huilé | All wooden parts in oak graphit, brushed, oiled
Weitere Beimöbel siehe Register 2 | Autres accessoires voir registre 2 | Further accessories see index 2

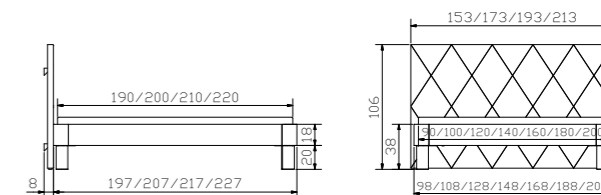



				Dimension cm
Qunito	Kommode	Commode	chest of drawers	90/50/86
Claudio iron	Herrendiener	Valet	dressboy	45/28/107
Twia	Nachttisch	Table de nuit	bedside table	45/50/41

				Dimension cm
Modul 18	Rahmen Breiten Längen	Cadre Largeurs Longueurs	Frame Widths Lengths	90, 100, 120, 140, 160, 180, 200 190, 200, 210, 220
Corno	Eckfüsse Höhen	Pieds d'angles Hauteurs	Corner feet Heights	20(38), 25(43), 30(48)
Alpa Lumo	Kopfteil Kissen, Rinovo anthracit 700	Tête de lit Coussin, Rinovo anthracit 700	Headboard Cushion, Rinovo anthracit 700	90/100, 120, 140, 160, 180, 200 90/100, 120, 140, 160, 180/200

Alle Holzteile in Eiche natur, gebürstet, geölt oder anthracit | Toutes les parties en bois en chêne naturel, brossé, huilé ou anthracite | All wooden parts in oak natural, brushed, oiled or anthracite

Weitere Beimöbel siehe Register 2 | Autres accessoires voir registre 2 | Further accessories see index 2

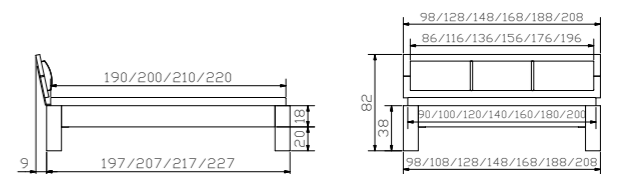



				Dimension cm
Alpa	Kopfteil	Tête de lit	Headboard	140, 160, 180, 200
Arona	Kissen, Capo linen 763	Coussin, Capo linen 7632	Cushion, Capo linen 763	140, 160, 180/200
Varus	Kopfteil	Tête de lit	Headboard	90/100, 120, 140, 160, 180, 200
Varo	Kissen (2er Set) Capo linen 763	Coussins (set de 2) Capo linen 763	Cushions (set of 2) Capo linen 763	55/10/35

				Dimension cm
Modul 18	Rahmen Breiten Längen	Cadre Largeurs Longueurs	Frame Widths Lengths	120, 140, 160, 180, 200 190, 200, 210, 220
Cora	Füße, Eckteile Breiten Höhe	Pieds, pièces d'angles Largeurs Hauteur	Feet, Corner pieces Lengths Height	120, 140, 160, 180, 200 20
Malta	Kopfteil, Capo linen 763 siehe Register 1	Tête de lit, Capo linen 763 voir registre 1	Headboard, Capo linen 763 see index 1	120, 140, 160, 180, 200
Atrine	Kommode	Commode	Chest of drawers	90/49/85
Onia	Nachttisch	Table de nuit	Bedside table	45/49/40

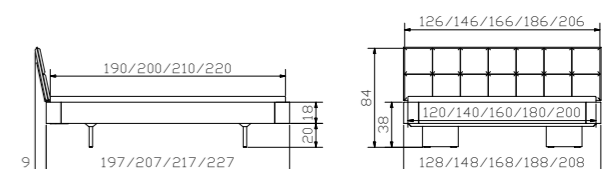
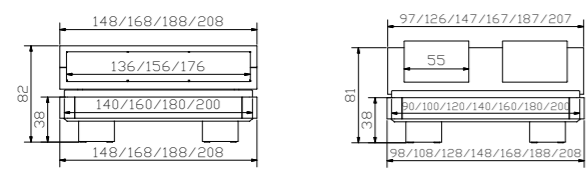

Alle Holzteile in Eiche natur, gebürstet, geölt oder weiss
 Toutes les parties en bois en chêne naturel, brossé, huilé ou blanc
 All wooden parts in oak natural, brushed, oiled or white

Weitere Beimöbel siehe Register 2
 Autres accessoires voir registre 2
 Further accessories see index 2

