



swiss bed concept



LOUNGE

MASSIVHOLZ | BOIS MASSIF | SOLID WOOD

Achten Sie auf FSC®-zertifizierte Produkte | Soyez attentifs aux produits certifiés FSC® | Look for FSC®-certified products

Bettrahmen | Cadre de lit | Bedframe

Lounge 18



Breiten | Largeurs | Widths
140, 160, 180 cm
Längen | Longueurs | Lengths
200, 210 cm
Einlegetiefe | Hauteur encastrable | Insertion depth:
18 cm

Traversen | Traverses | Bars

Wir empfehlen grundsätzlich den Einsatz von Crosstraver (Quertraverse) oder Midtraver (Längstraverse).
Nous recommandons en général l'utilisation de Crosstraver (traverse transversale) ou Midtraver (traverse centrale).
We recommend basically the insertion of Crosstraver (central cross bar) or Midtraver (central bar).

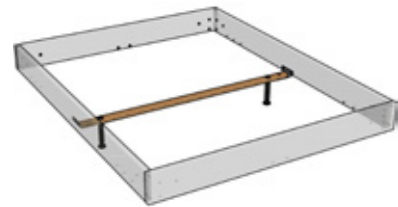

Crosstraver
Quertraverse | Traverse transversale | Central cross bar

Für alle Bettbreiten | Pour toutes les largeurs de lit | For all bed widths

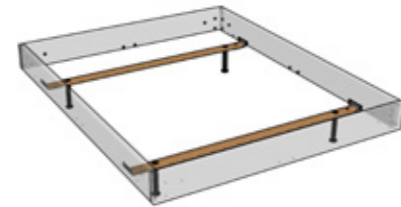

Crosstraver-Twin
Quertraversen | Traverses transversales | Cross bars

Für alle Bettbreiten | Pour toutes les largeurs de lit | For all bed widths

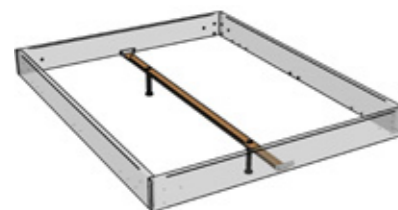

Midtraver
Längstraverse | Traverse centrale | Central bar

Für Betten ab Breite 140 cm mit 2 Lattenrosten oder Motorrahmen-einbau | Pour les lits à partir de 140 cm de largeur avec 2 sommiers ou l'installation d'un cadre motorisé | For beds from 140 cm width with 2 slats or motor frame installation

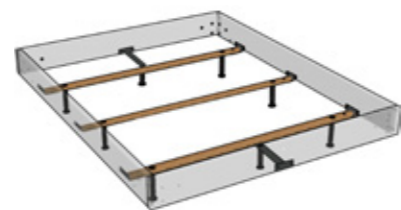

Crosstraver-XXL
Quertraversen | Traverses transversales | Cross bars

Für alle Bettbreiten | Pour toutes les largeurs de lit | For all bed widths

Übersicht Kompatibilität Traversen siehe Seite 2.12 | Aperçu compatibilité traverses voir page 2.12 | Overview compatibility bars see page 2.12

Füsse | Pieds | Feet



Holz | Bois | Wood

| | Höhen cm Hauteurs cm Heights cm | | Holzfarben Couleurs bois Colours wood | | | | | |
|----------------|---------------------------------------|----|---------------------------------------------|----|----|----|----|----|
| | 20 | 25 | 10 | 16 | 74 | 82 | 87 | 99 |
| Pile | ● | ● | ● | ● | ● | ● | ● | ● |
| Practico-Rono* | | ● | ● | ● | | | | ● |
| Masino | ● | ● | ● | | ● | ● | ● | ● |

*weiss/anthrazit = MDF | blanc/anthracite = MDF | white/anthracite = MDF

Metall | Métal | Metal

| | Höhen cm Hauteurs cm Heights cm | | Metallfarben Couleurs métal Colours metal | |
|---------|---------------------------------------|----|-------------------------------------------------|----|
| | 20 | 25 | 16 | 42 |
| Tondino | ● | ● | ● | ● |
| Locito | ● | ● | ● | ● |
| Glyn | ● | ● | ● | ● |

Holz | Bois | Wood

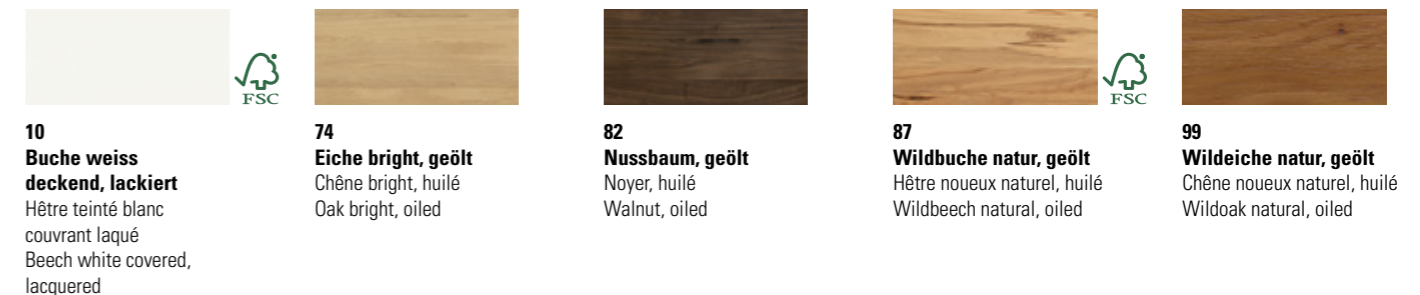

Metall | Métal | Metal



16 Anthracit = Stahl pulverbeschichtet | Acier thermolaqué | Steel powder-coated
42 Alu = Stahl pulverbeschichtet | Acier thermolaqué | Steel powder-coated

Kopfteile | Têtes de lit | Headboards

Wave



Dimension: 140, 160, 180

*Turano



Dimension: 140, 160, 180

Kulm



Dimension: 140, 160, 180

Lola + Kulm

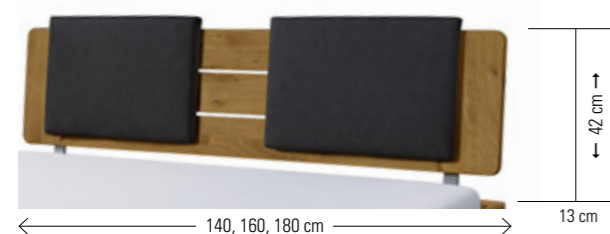

Dimension: 140, 160, 180

Comfy

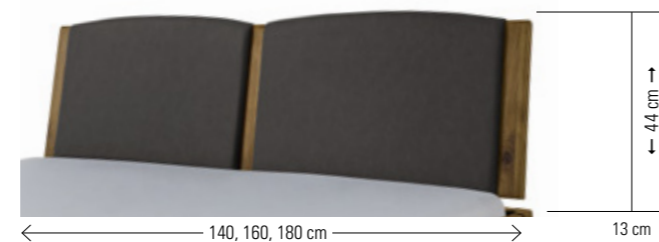

Dimension: 140, 160, 180

Lecco



Dimension: 140, 160, 180

Boga



Dimension: 140, 160, 180

Stoff- und Kunstlederauswahl

Choix de tissus
Choice of tissues

Pepe (100 % Polyester)

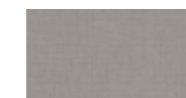

335 grey

Kul (Oberfläche | Surface 100% Polyurethan)

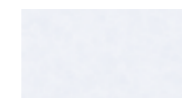

323 white



336 smoke

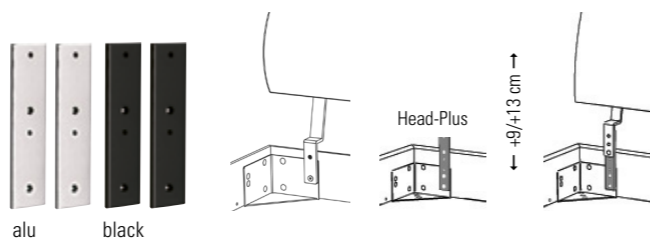

Adapter | Adaptateur | Adapter

Bei hohen Matratzen kann mit dem Verlängerungsadapter das Kopfteil erhöht werden.

La tête de lit peut être rehaussée avec l'adaptateur lorsque le matelas est plus épais. With the extension adapter the headboard can be extended if mattresses are high.

Head-Plus (2er Set | set de 2 | set of 2)

Head-Plus für Comfy | pour Comfy | for Comfy (3er Set | set de 3 | set of 3)

Metal | Métal | Metal

*ausschliesslich in Nussbaum 82, Wildbuche natur 87 und Wildeiche natur 99 | exclusivement en noyer 82, hêtre nouveau naturel 87 et chêne nouveau naturel 99 | exclusively in walnut 82, wildbeech natural and wildoak natural 99

Nachttische | Tables de nuit | Bedside tables



Drift



Seva



Stand



Surf

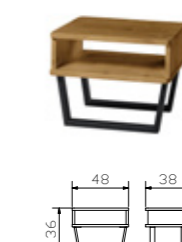

Styly



Ausführungen für Kopfteile und Nachttische | Exécutions pour tables de nuit et têtes de lit

Executions for bedside tables and headboards

| | | | | |
|------------------------------------------------------------------------------------------------------------------------------|-----------------------------------------------------------------------------------------|--------------------------------------------------------------------------|------------------------------------------------------------------------------------------------------------|----------------------------------------------------------------------------------------------------------|
| 10 Buche weiss deckend, lackiert Hêtre teinté blanc couvrant laqué Beech white covered, lacquered | 74 Eiche bright, geölt Chêne bright, huilé Oak bright, oiled | 82 Nussbaum, geölt Noyer, huilé Walnut, oiled | 87 Wildbuche natur, geölt Hêtre nouveau naturel, huilé Wildbeech natural, oiled | 99 Wildeiche natur, geölt Chêne nouveau naturel, huilé Wildoak natural, oiled |
|------------------------------------------------------------------------------------------------------------------------------|-----------------------------------------------------------------------------------------|--------------------------------------------------------------------------|------------------------------------------------------------------------------------------------------------|----------------------------------------------------------------------------------------------------------|

Bettkasten | Coffres à literie | Bedding boxes

Roll-Box 20/25



Roll-Box 20/25 + Covero



Roll-Box 20/25 + Saceto



Bettkasten in weiss oder anthrazit (Boden weiss)

Tiroir de lit en blanc ou anthracite (fond blanc)

Bed drawer in white or anthracite (bottom white)

Voraussetzung

Bettfusshöhe von mindestens 20 cm erforderlich

Condition préalable

Une hauteur de pieds de lit d'au moins 20 cm.

Condition

Feet of bed need a minimum height of 20 cm.

Optionen

Deckel Covero in weiss, Stoffabdeckung Saceto in Polyester grau.

Options

Couvercle Covero en blanc, tissu de protection Saceto en polyester gris.

Options

Covero en blanc, tissu de protection Saceto en polyester gris.

Ausführungen für Bettkasten-Front | Exécutions pour façades coffres à literie | Executions for fronts of bedding boxes

| | | | |
|-------------------------------------------------------------------------------------------------------------------------------|---------------------------------------------------------------------------------------------------------------------------------------------|-----------------------------------------------------------------------------------------|--------------------------------------------------------------------------------------------------------------------------------------|
| 10 Buche weiss deckend, lackiert Hêtre teinté blanc couvrant, laqué Beech white covered, lacquered | 16 Buche anthracit deckend, lackiert Hêtre teinté anthracite couvrant, laqué Beech anthracite covered, lacquered | 74 Eiche bright, geölt Chêne bright, huilé Oak bright, oiled | 93 Wildeiche natur, gebürstet, geölt Chêne nouveau naturel, brossé, huilé Wildoak natural, brushed, oiled |
|-------------------------------------------------------------------------------------------------------------------------------|---------------------------------------------------------------------------------------------------------------------------------------------|-----------------------------------------------------------------------------------------|--------------------------------------------------------------------------------------------------------------------------------------|

selezione

01

MODELLAUSWAHL

Sélection du modèle | Model selection

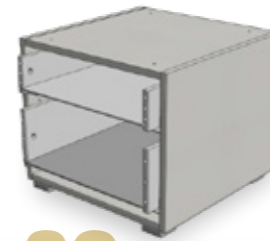
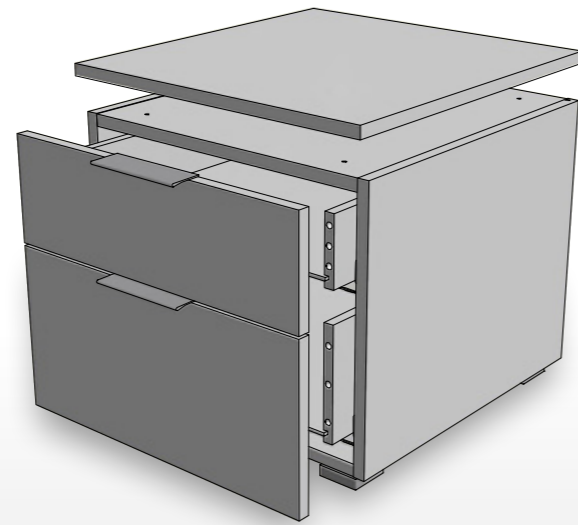

02

KORPUS

Caisson | Body



03

TOP/FRONT

Farben | Couleurs | Colours

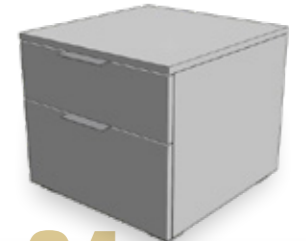

04

GRIFFE

Poignées | Handles

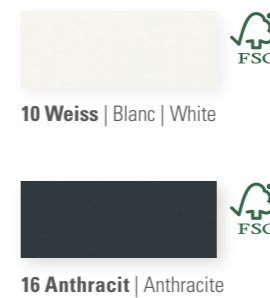
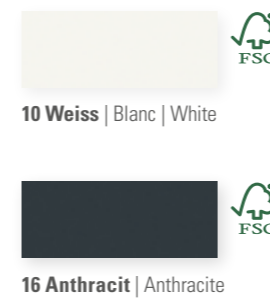
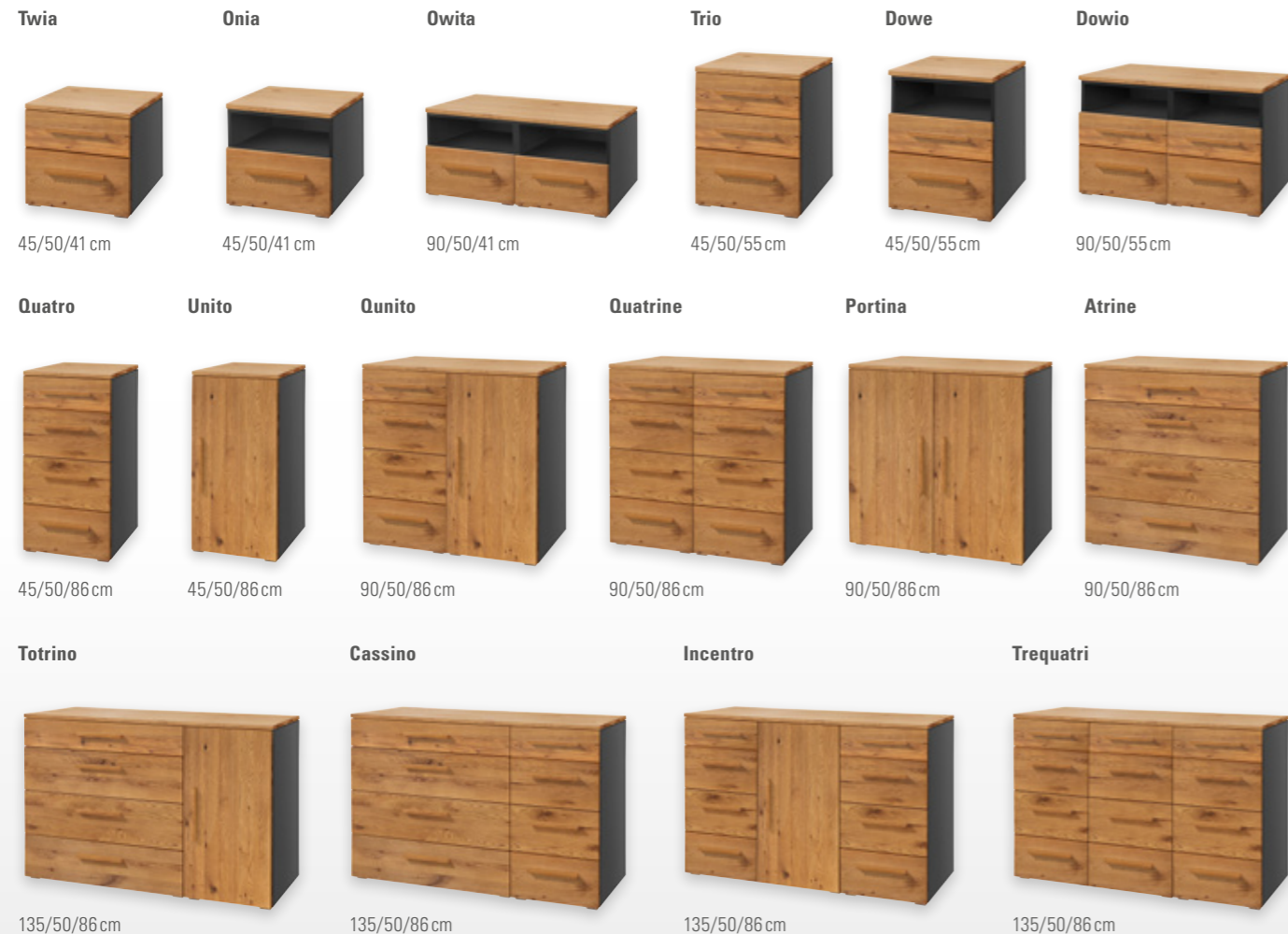

STANDARD



OPTION

Leg 8 cm Jone 10 cm Cila 10 cm

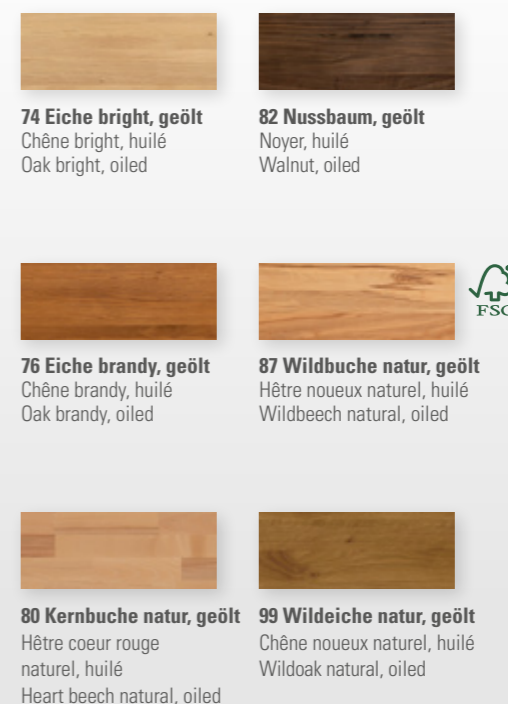

STANDARD



Alu
Griff zu Folienfronten
Poignée pour façades en mélaminé
Handle for foil fronts

STANDARD



Holzgriff zu Holzfronten
Poignée en bois pour façades en bois
Wooden handle for wooden fronts

OPTION

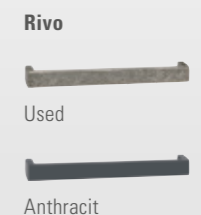

Metallgriff zu Holzfronten
Poignée en métal pour façades en bois
Metal handle for wooden fronts

Stellen Sie sich Ihr Wunsch-Beimöbel nach Ihrem Geschmack zusammen: Der Korpus (Abb. 02), in zwei verschiedenen Farbvarianten, lässt sich zu den Front- und Top-Covern (Abb. 03) in acht Holz- und Farbausführungen kombinieren. Die Beimöbel können zerlegt oder teilmontiert bestellt werden. Bei zusammengesetzten Möbeln (z. B. Qunito, Incentro, ...) muss der Deckel noch montiert werden. Bei Kommoden mit Türen ist jeweils ein Einlegeboden vorhanden, Türöffnung nach links oder rechts möglich. Zusätzliche Böden sind erhältlich.

Composez le meuble d'appoint de vos rêves selon vos goûts : Le caisson (ill. 02), disponible en 2 variantes de couleurs, peut être combiné avec les façades et couvercles supérieurs (ill. 03) en 8 finitions de bois et de coloris. Les meubles d'appoint peuvent être commandés en kits ou assemblés. Pour les meubles assemblés (p. ex. Qunito, Incentro, ...) le couvercle doit encore être fixé. Les commodes avec portes sont équipées d'une étagère, ouverture de la porte possible à gauche ou à droite. Si besoin, des étagères supplémentaires sont disponibles.

Put together the side furniture you want according to your own taste: The body (fig. 02), in two different colour versions, can be combined with the front and top covers (fig. 03) in eight wood and colour versions. The furniture can be ordered disassembled or assembled. For assembled furniture (e.g. Qunito, Incentro, ...) the top cover must still be fitted. Chests of drawers with doors have one shelf, door opening possible to the left or right. Additional shelves are available.



Kombinationsbeispiele und techn. Informationen
Exemples et informations
Examples and informations



Lattenroste | Sommier | Slats



Dritto U

U = Unverstellbar
Non réglable
Not adjustable

Rahmenholme und 14 Federleisten aus Buchenschichtholz
Cadre et 14 lattes en hêtre multiplis
Frame and 14 slats are of beech veneer board

Starre Lagerung
Suspension rigide
Rigid suspension

Längen | Longueurs | Lengths

200

Höhe | Hauteur | Height: 6 cm

Keine Sondermasse möglich | Dimensions spéciales non disponibles |
No special sizes possible

Breiten | Largeurs | Widths

80 90 140

● ● ●



Flexo K

K = Kopfteil manuell 13-fach verstellbar
Réglage manuel de la tête en 13 positions
Head piece manually adjustable in 13 positions

Rahmenholme und 28 Federleisten aus Buchenschichtholz
Cadre et 28 lattes en hêtre multiplis
Frame and 28 slats are of beech veneer board

Flexible Lagerung
Suspension flexible
Flexible suspension

Schulterkomfortzone
Zone de confort des épaules
Comfort zone for shoulders

Mittelzonenverstärkung
Zone médiane renforcée
Reinforcement of the middle zone

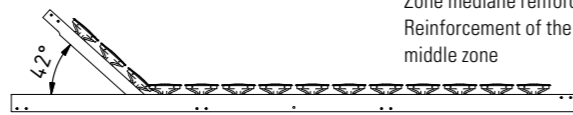

Längen | Longueurs | Lengths

200, 210

Höhe | Hauteur | Height: 9 cm

Keine Sondermasse möglich | Dimensions spéciales non disponibles |
No special sizes possible

Breiten | Largeurs | Widths

80 90 140

● ● ●



Ultrafree RF

RF = Rücken- und Fussteil manuell je 13-fach verstellbar
Réglage manuel pour le haut du corps et les jambes en 13 positions
Back and foot sections manually adjustable in 13 positions

Rahmenholme und 30 Federleisten aus Buchenschichtholz
Cadre et 30 lattes en hêtre multiplis
Frame and 30 slats are of beech veneer board

Details siehe Seite 14.2–14.3
Détails voir page
Details see page:



Längen | Longueurs | Lengths

200, 210

Höhe | Hauteur | Height: 10 cm

Keine Sondermasse möglich | Dimensions spéciales non disponibles |
No special sizes possible

Breiten | Largeurs | Widths

80 90 140

● ● ●

Matratzen | Matelas | Mattresses

Novo

7-Zonen-Kaltschaumkern, Höhe 8 cm in Härtegrad H3 (RG 35) erhältlich
7-zones noyau en mousse froide, hauteur 8 cm disponible dans le degré de fermeté f3 (densité 35)
7-zones core cold foam, height 8 cm available in the degree of hardness H3 (density 35)

Optimale Unterstützung durch 7-Zonen-Kaltschaum-Noppenprofil in 2.5 cm Stärke
Soutien optimal grâce à une mousse 7-zones froide à picots 2.5 cm
Optimum support through 7-zones cold foam upholstery 2.5 cm with nobs

Breiten | Largeurs | Widths 80, 90, 140, 160, 180 cm

Längen | Longueurs | Lengths 200, 210 cm

Höhe | Hauteur | Height 16 cm

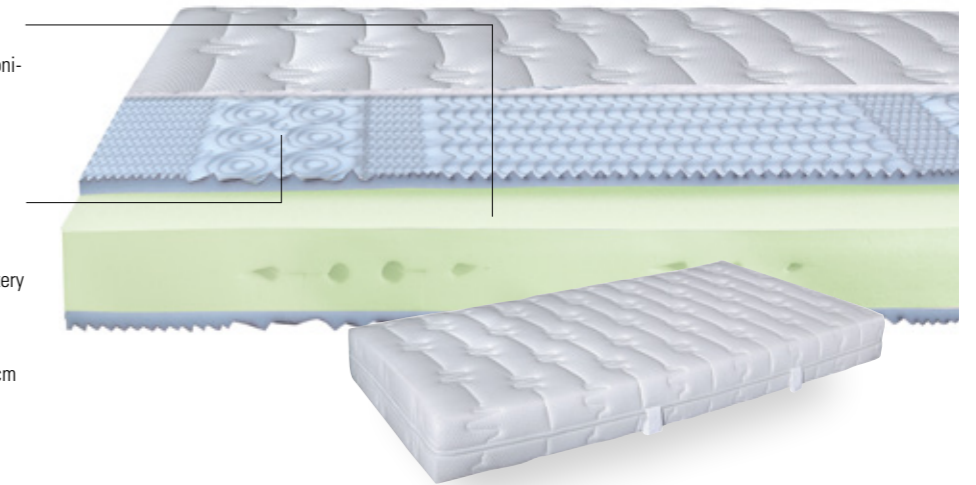

Ultraconfort

7-Zonen-Kaltschaumkern, Höhe 12 cm in den Härtegraden H3 (RG 45) und H4 (RG 50) erhältlich
7-zones noyau en mousse froide, hauteur 12 cm disponible dans les degrés de fermeté f3 (densité 45) et f4 (densité 50)
7-zones core cold foam, height 12 cm available in the degrees of hardness H3 (density 45) and H4 (density 50)

Optimale Unterstützung und Klimatisierung durch 4 cm Soft-Kaltschaum-Auflage RG 60
Soutien optimal et climatisation idéale grâce à une mousse froide souple 4 cm densité 60
Optimum support and climate regulation through 4 cm soft cold foam upholstery density 60

Breiten | Largeurs | Widths 80, 90, 140, 160, 180 cm

Längen | Longueurs | Lengths 200, 210 cm

Höhe | Hauteur | Height 21 cm

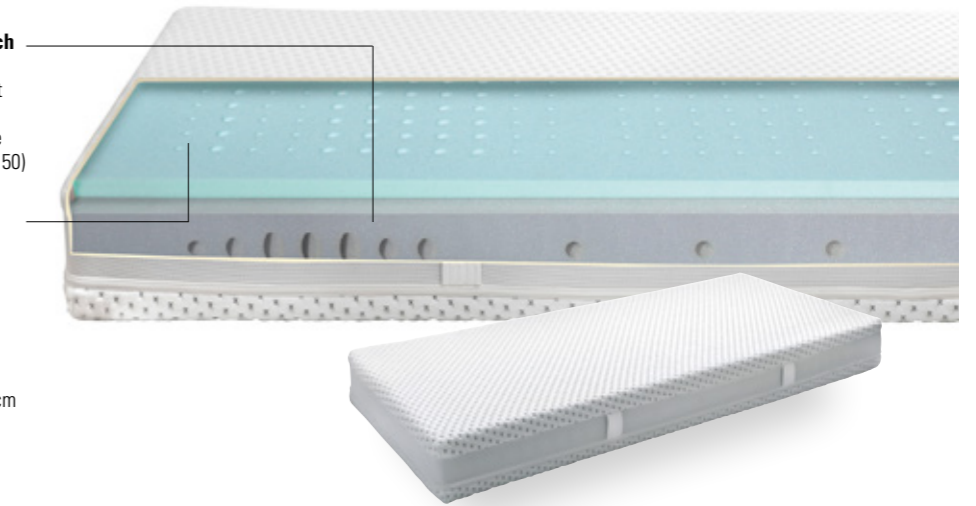

Ultramotion

7-Zonen-Kaltschaum-Tröpfchenkern mit Querbelüftung und Schulterzone, Höhe 20 cm in den Härtegraden H2 (RG 53), H3 (RG 53) und H4 (RG 45) erhältlich

7-zones noyau de gouttelettes en mousse froide avec ventilation transversale et zone pour les épaules, hauteur 20 cm disponible dans les degrés de fermeté f2 (densité 53), f3 (densité 53) et f4 (densité 45)
7-zones cold foam droplet core with lateral ventilation and shoulder zone, height 20 cm available in the degrees of hardness H2 (density 53), H3 (density 53) and H4 (density 45)

Breiten | Largeurs | Widths 80, 90, 140, 160, 180 cm

Längen | Longueurs | Lengths 200, 210 cm

Höhe | Hauteur | Height 23 cm

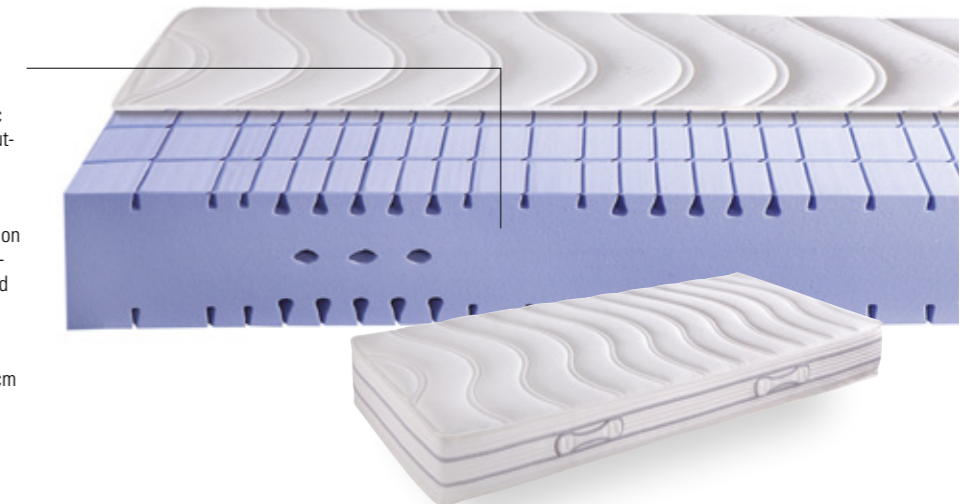

Informationen zu Matratzenbezügen und weitere Lattenroste und Matratzen siehe Register 14

Informations sur les housses de matelas et autres sommier et matelas, voir registre 14
Information on mattress covers and other slatted frames and mattresses, see tab 14

Entwickelt für den Bettkasten Practico-Rono | Développé pour le coffre à literie Practico-Rono | Developed for the bedding-box Practico-Rono



Ultrafree-Lift KF

Rahmenholme und 28 Federleisten aus Buchenschichtholz

Cadre et 28 lattes en hêtre multiplis
Frame and 28 slats are of beech veneer board

Schulterkomfortzone

Zone de confort des épaules
Comfort zone for shoulders

Fusshochlagerung – 3-stufig

Pied relevable – 3 niveaux
Footpiece – 3 levels

Flexible Lagerung

Suspension flexible
Flexible suspension

Rahmenöffnung durch Gasdruckfedern

Ouverture du cadre par piston à gaz
Opening of the frame by the use of pneumatic compression spring

Längen | Longueurs | Lengths

Breiten | Largeurs | Widths

200, 210

| | | |
|----|----|-----|
| 80 | 90 | 140 |
|----|----|-----|

Höhe | Hauteur | Height: 11 cm

Keine Sondermasse möglich | Dimensions spéciales non disponibles | No individual sizes possible

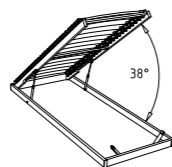

Econom-move

Rahmenholme und 28 Federleisten aus Buchenschichtholz

Cadre et 28 lattes en hêtre multiplis
Frame and 28 slats are of beech veneer board

Links und rechts einsetzbar

Utilisable à gauche et à droite
Can be used left and right

Schulterkomfortzone

Zone de confort des épaules
Comfort zone for shoulders

Flexible Lagerung

Suspension flexible
Flexible suspension

Rahmenöffnung durch Gasdruckfedern

Ouverture du cadre par piston à gaz
Opening of the frame by the use of pneumatic compression spring

Längen | Longueurs | Lengths

Breiten | Largeurs | Widths

200, 210

| | |
|----|----|
| 80 | 90 |
|----|----|

Höhe | Hauteur | Height: 9 cm

Keine Sondermasse möglich | Dimensions spéciales non disponibles | No individual sizes possible

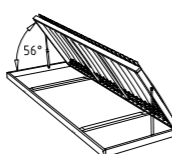

Lounge 18

Rahmen
Breiten
Längen

Cadre
Largeurs
Longueurs

Frame
Widths
Lengths

Dimension cm

140, 160, 180
200, 210

Masino

Füsse
Höhen

Pieds
Hauteurs

Feet
Heights

20, 25

Comfy

Kopfteil
Kul white 323

Tête de lit
Kul white 323

Headboard
Kul white 323

140, 160, 180

Seva

Nachttisch

Table de nuit

Bedside table

48/38/16



Alle Holzteile in Eiche bright, geölt
Toutes les parties en bois en chêne bright, huilé
All wooden parts in oak bright, oiled

Weitere Beimöbel siehe Register 2
Autres accessoires voir registre 2
Further accessories see index 2

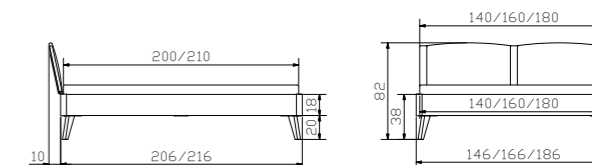



| | | | | Dimension cm |
|----------------|------------|---------------|---------------|--------------|
| Surf anthracit | Nachttisch | Table de nuit | Bedside table | 48/38/36 |

| | | | | Dimension cm |
|-----------------------|-----------------------------|--------------------------------|----------------------------|---------------------------|
| Lounge 18 | Rahmen Breiten Längen | Cadre Largeurs Longueurs | Frame Widths Lengths | 140, 160, 180 200, 210 |
| Glyn anthracit | Füße Höhen | Pieds Hauteurs | Feet Heights | 20, 25 |
| Wave | Kopfteil | Tête de lit | Headboard | 140, 160, 180 |



Alle Holzteile in Nussbaum, geölt | Toutes les parties en bois en noyer, huilé | All wooden parts in walnut, oiled
 Weitere Beimöbel siehe Register 2 | Autres accessoires voir registre 2 | Further accessories see index 2

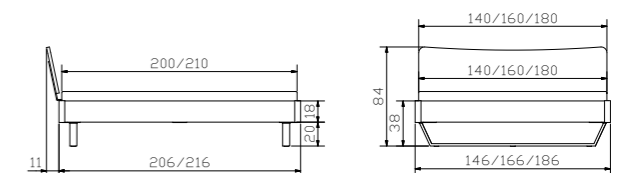

1



2



3



4



- 1. Holzteile in Wildeiche natur, geölt** | Parties en bois en chêne nouveau naturel, huilé | All wooden parts in wildoak natural, oiled
2. Holzteile in Buche weiss, deckend, lackiert | Parties en bois en hêtre teinté blanc couvrant, laqué | All wooden parts in beech white covered, lacquered
3. Holzteile in Nussbaum, geölt | Parties en bois en noyer, huilé | All wooden parts in walnut, oiled
4. Holzteile in Eiche bright, geölt | Parties en bois en chêne bright, huilé | All wooden parts in oak bright, oiled



| | | | | Dimension cm |
|------------------|------------|---------------|---------------|---------------|
| Lounge 18 | Rahmen | Cadre | Frame | |
| | Breiten | Largeurs | Widths | 140, 160, 180 |
| | Längen | Longueurs | lengths | 200, 210 |
| Pile | Füsse | Pieds | Feet | |
| | Höhen | Hauteurs | Heights | 20, 25 |
| Kulm | Kopfteil | Tête de lit | Headboard | 140, 160, 180 |
| Seva | Nachttisch | Table de nuit | Bedside table | 48/38/16 |



Alle Holzteile in Wildbuche natur, geölt
 Toutes les parties en bois en hêtre nouveau naturel, huilé
 All wooden parts in wildbeech natural, oiled

Weitere Beimöbel siehe Register 2
 Autres accessoires voir registre 2
 Further accessories see index 2

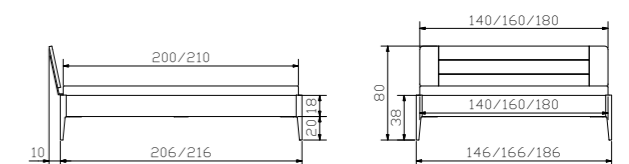



| | | | | Dimension cm |
|--------------|------------|---------------|---------------|--------------|
| Drift | Nachttisch | Table de nuit | Bedside table | 48/38/9 |

| | | | | Dimension cm |
|------------------|-------------------|-----------------------|-------------------|---------------------------|
| Lounge 18 | Rahmen | Cadre | Frame | 140, 160, 180 200, 210 |
| | Breiten Längen | Largeurs Longueurs | Widths Lengths | |
| Pile | Füsse | Pieds | Feet | 20, 25 |
| | Höhen | Hauteurs | Heights | |
| Lecco | Kopfteil | Tête de lit | Headboard | 140, 160, 180 |
| | Pepe grey 335 | Pepe grey 335 | Pepe grey 335 | |



Alle Holzteile in Buche weiss, deckend, lackiert | Toutes les parties en bois en hêtre teinté blanc couvrant, laqué | All wooden parts in beech white covered, lacquered

Weitere Beimöbel siehe Register 2 | Autres accessoires voir registre 2 | Further accessories see index 2

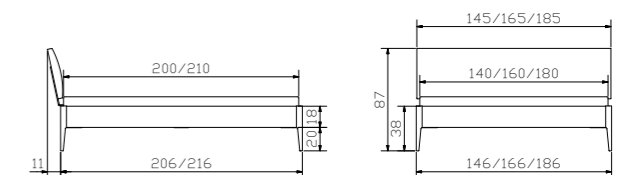



| Style | Nachttisch | Table de nuit | Beside table | Dimension cm |
|-------|------------|---------------|--------------|--------------|
| | | | | 43/43/48 |

| | Rahmen Breiten Längen | Cadre Largeurs Longueurs | Frame Widths Lengths | Dimension cm |
|------------------|-----------------------------|--------------------------------|----------------------------|---------------------------|
| Lounge 18 | | | | 140, 160, 180 200, 210 |
| Pile | Füße Höhen | Pieds Hauteurs | Feet Heights | 20, 25 |
| Boga | Kopfteil Pepe grey 335 | Tête de lit Pepe grey 335 | Headboard Pepe grey 335 | 140, 160, 180 |



Alle Holzteile in Eiche bright, geölt | Toutes les parties en bois en chêne bright, huilé | All wooden parts in oak bright, oiled
 Weitere Beimöbel siehe Register 2 | Autres accessoires voir registre 2 | Further accessories see index 2

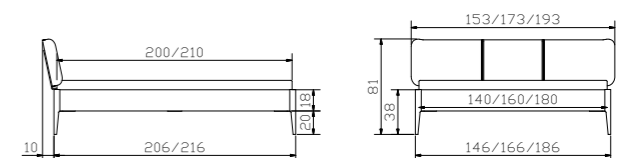



| | | | | Dimension cm |
|----------------|------------|---------------|--------------|--------------|
| Surf anthracit | Nachttisch | Table de nuit | Beside table | 48/38/36 |

| | | | | Dimension cm |
|-----------------------|-------------------|-----------------------|-------------------|---------------------------|
| Lounge 18 | Rahmen | Cadre | Frame | 140, 160, 180 200, 210 |
| | Breiten Längen | Largeurs Longueurs | Widths Lengths | |
| Glyn anthracit | Kufen | Patins | Vats | 140, 160, 180 20, 25 |
| | Breiten Höhen | Largeurs Hauteurs | Widths Heights | |
| Turano | Kopfteil | Tête de lit | Headboard | 140, 160, 180 |



Alle Holzteile in Wildeiche natur, geölt | Toutes les parties en bois en chêne naturel, huilé | All wooden parts in wildoak natural, oiled
 Weitere Beimöbel siehe Register 2 | Autres accessoires voir registre 2 | Further accessories see index 2

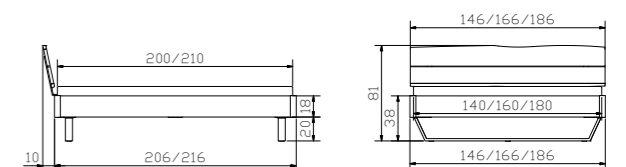

1



2



3



1. Holzteile in Wildeiche natur, geölt | Parties en bois en chêne nouveau naturel, huilé | Wooden parts in wildoak natural, oiled
 2. Holzteile in Eiche bright, geölt | Parties en bois en chêne bright, huilé | Wooden parts in oak bright, oiled
 3. Holzteile in Wildbuche natur, geölt | Parties en bois en hêtre nouveau naturel, huilé | Wooden parts in wildbeech natural, oiled



7.22

| | | | | Dimension cm |
|-----------------------------------|-----------------------------|--------------------------------|----------------------------|---------------------------|
| Lounge 18 | Rahmen Breiten Längen | Cadre Largeurs Longueurs | Frame Widths Lengths | 140, 160, 180 200, 210 |
| Locito anthracit | Füße Höhe | Pieds Hauteur | Feet Height | 20 |
| Lecco | Kopfteil Kul smoke 336 | Tête de lit Kul smoke 336 | Headboard Kul smoke 336 | 140, 160, 180 |
| Dowe Cila 10 anthracit | Nachttisch Füße | Table de nuit Pieds | Bedside table Feet | 45/50/55 10 |



Alle Holzteile in Nussbaum, geölt
 Toutes les parties en bois en noyer, huilé
 All wooden parts in walnut, oiled

Weitere Beimöbel siehe Register 2 | Autres accessoires voir registre 2 |
 Further accessories see index 2

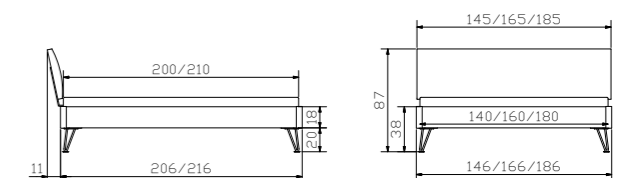

7.23



| | | | | Dimension cm |
|-------------|------------|---------------|---------------|--------------|
| Seva | Nachttisch | Table de nuit | Bedside table | 48/38/16 |

| | | | | Dimension cm |
|--------------------------|-----------------------------|--------------------------------|----------------------------|---------------------------|
| Lounge 18 | Rahmen Breiten Längen | Cadre Largeurs Longueurs | Frame Widths Lengths | 140, 160, 180 200, 210 |
| Tondino anthracit | Füße Höhe | Pieds Hauteur | Feet Height | 20 |
| Lecco | Kopfteil Kul smoke 336 | Tête de lit Kul smoke 336 | Headboard Kul smoke 336 | 140, 160, 180 |



Alle Holzteile in Wildbuche natur, geölt | Toutes les parties en hêtre nouveau naturel, huilé | All wooden parts in wildbeech natural, oiled
Weitere Beimöbel siehe Register 2 | Autres accessoires voir registre 2 | Further accessories see index 2

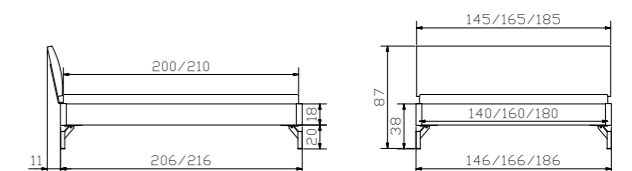



| Style | Nachttisch | Table de nuit | Beside table | Dimension cm |
|-------|------------|---------------|--------------|--------------|
| | | | | 43/43/48 |

| | Rahmen Breiten Längen | Cadre Largeurs Longueurs | Frame Widths Lengths | Dimension cm |
|------------------|-----------------------------|--------------------------------|----------------------------|---------------------------|
| Lounge 18 | | | | 140, 160, 180 200, 210 |
| Pile | Füsse Höhen | Pieds Hauteurs | Feet Heights | 20, 25 |
| Wave | Kopfteil | Tête de lit | Headboard | 140, 160, 180 |



Roll-Box 20 + 25
Wildeiche natur, gebürstet, geölt
 Chêne nouveau naturel, brossé, huilé
 Wildoak natural, brushed, oiled



Alle Holzteile in Wildeiche natur, geölt
 Toutes les parties en bois en chêne nouveau naturel, huilé
 All wooden parts in wildoak natural, oiled

Weitere Beimöbel siehe Register 2
 Autres accessoires voir registre 2
 Further accessories see index 2

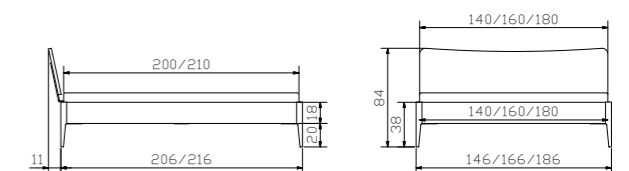



| | | | | Dimension cm |
|-------------|------------|---------------|---------------|--------------|
| Seva | Nachttisch | Table de nuit | Bedside table | 48/38/16 |

| | | | | Dimension cm |
|------------------|-----------------------------|--------------------------------|----------------------------|---------------------------|
| Lounge 18 | Rahmen Breiten Längen | Cadre Largeurs Longueurs | Frame Widths Lengths | 140, 160, 180 200, 210 |
| Pile | Füsse Höhen | Pieds Hauteurs | Feet Heights | 20, 25 |
| Comfy | Kopfteil Pepe grey 335 | Tête de lit Pepe grey 335 | Headboard Pepe grey 335 | 140, 160, 180 |



Alle Holzteile in Buche weiss, deckend, lackiert | Toutes les parties en bois en hêtre teinté blanc couvrant, laqué | All wooden parts in beech white covered, lacquered

Weitere Beimöbel siehe Register 2 | Autres accessoires voir registre 2 | Further accessories see index 2

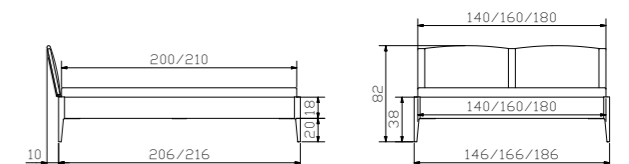



| | | | | Dimension cm |
|--------------|------------|---------------|--------------|--------------|
| Stand | Nachttisch | Table de nuit | Beside table | 48/38/42 |

| | | | | Dimension cm |
|------------------|-----------------------------|--------------------------------|----------------------------|---------------------------|
| Lounge 18 | Rahmen Breiten Längen | Cadre Largeurs Longueurs | Frame Widths Lengths | 140, 160, 180 200, 210 |
| Masino | Füße Höhen | Pieds Hauteurs | Feet Heights | 20, 25 |
| Kulm | Kopfteil | Tête de lit | Headboard | 140, 160, 180 |



Alle Holzteile in Eiche bright, geölt | Toutes les parties en bois en chêne bright, huilé | All wooden parts in oak bright, oiled
Weitere Beimöbel siehe Register 2 | Autres accessoires voir registre 2 | Further accessories see index 2

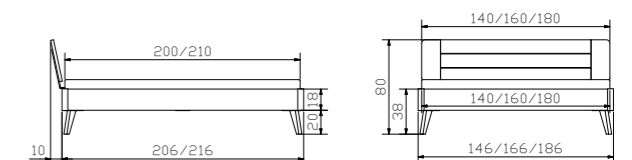



| | | | | Dimension cm |
|----------------|------------|---------------|---------------|--------------|
| Surf anthracit | Nachttisch | Table de nuit | Bedside table | 48/38/36 |

| | | | | Dimension cm |
|-----------------------|-------------------|-----------------------|-------------------|---------------------------|
| Lounge 18 | Rahmen | Cadre | Frame | 140, 160, 180 200, 210 |
| | Breiten Längen | Largeurs Longueurs | Widths Lengths | |
| Glyn anthracit | Füße | Pieds | Feet | 20, 25 |
| | Höhen | Hauteurs | Heights | |
| Comfy | Kopfteil | Tête de lit | Headboard | 140, 160, 180 |
| | Kul smoke 336 | Kul smoke 336 | Kul smoke 336 | |



Alle Holzteile in Wildeiche natur, geölt | Toutes les parties en bois en chêne nouveau naturel, huilé | All wooden parts in wildoak natural, oiled
Weitere Beimöbel siehe Register 2 | Autres accessoires voir registre 2 | Further accessories see index 2

