



swiss bed concept



WOOD LINE

MASSIVHOLZ | BOIS MASSIF | SOLID WOOD

Achten Sie auf FSC®-zertifizierte Produkte | Soyez attentifs aux produits certifiés FSC® | Look for FSC®-certified products



Bettrahmen | Cadre de lit | Bedframe



Classic 16



Breiten | Largeurs | Widths:
90, 100, 120, 140, 160, 180, 200 cm

Längen | Longueurs | Lengths: 190, 200, 210, 220 cm

Einlegetiefe | Hauteur encastrable | Insertion depth:
16 cm

Der Classic 16 Rahmen ist nicht in Eiche bright und Eiche brandy erhältlich.
Le cadre Classic 16 n'est pas disponible en chêne bright et en chêne brandy.
The Classic 16 frame is not available in oak bright and oak brandy.

Premium 18



Breiten | Largeurs | Widths:
90, 100, 120, 140, 160, 180, 200 cm

Längen | Longueurs | Lengths:
200, 210, 220 cm

Einlegetiefe | Hauteur encastrable | Insertion depth:
18 cm

Premium 23



Breiten | Largeurs | Widths:
140, 160, 180, 200 cm

Längen | Longueurs | Lengths:
200, 210, 220 cm

Einlegetiefe | Hauteur encastrable | Insertion depth:
18*, 23 cm

Ausführungen | Exécutions | Executions

Holz | Bois | Wood



06 Buche natur, lackiert
Hêtre naturel, laqué
Natural beech, lacquered



07 Buche schoko, lackiert
Hêtre teinté chocolat, laqué
Beech chocolate coloured, lacquered

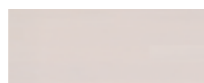

09 Buche weiss lasiert, lackiert
Hêtre teinté blanc lasuré, laqué
Beech white stained, lacquered



74 Eiche bright, geölt
Chêne bright, huilé
Oak bright, oiled



76 Eiche brandy, geölt
Chêne brandy, huilé
Oak brandy, oiled



80 Kernbuche natur, geölt
Hêtre cœur rouge naturel, huilé
Heart beech natural, oiled

Traversen | Traverses | Bars

Wir empfehlen grundsätzlich den Einsatz von Crosstraver (Quertraverse) oder Midtraver (Längstraverse).
Nous recommandons en général l'utilisation de Crosstraver (traverse transversale) ou Midtraver (traverse centrale).
We recommend basically the insertion of Crosstraver (central cross bar) or Midtraver (central bar).

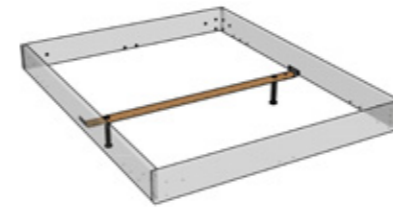

Crosstraver
Quertraverse | Traverse transversale | Central cross bar

Für alle Bettbreiten | Pour toutes les largeurs de lit | For all bed widths

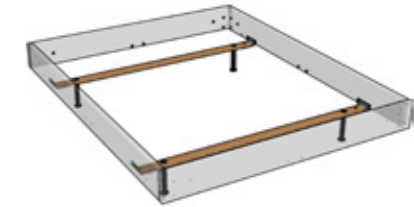

Crosstraver-Twin
Quertraversen | Traverses transversales | Cross bars

Für alle Bettbreiten | Pour toutes les largeurs de lit | For all bed widths

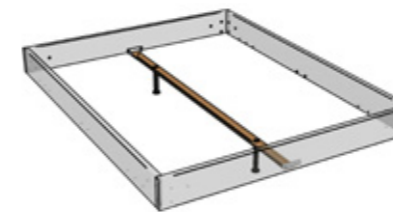

Midtraver
Längstraverse | Traverse centrale | Central bar

Für Betten ab Breite 140 cm mit 2 Lattenrosten oder Motorrahmen-einbau | Pour les lits à partir de 140 cm de largeur avec 2 sommiers ou l'installation d'un cadre motorisé | For beds from 140 cm width with 2 slats or motor frame installation

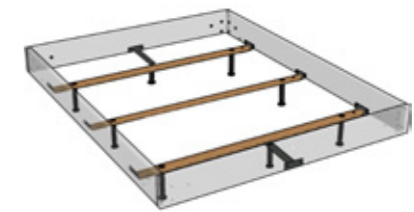

Crosstraver-XXL
Quertraversen | Traverses transversales | Cross bars

Für alle Bettbreiten | Pour toutes les largeurs de lit | For all bed widths

Übersicht Kompatibilität Traversen siehe Seite 2.12 | Aperçu compatibilité traverses voir page 2.12 | Overview compatibility bars see page 2.12

* Premium 23

Bei der Einlegetiefe 18 cm sind die Füße/Sockel um 5 cm versenkt und um diese Höhe weniger sichtbar.

Avec les équerres en position haute (18 cm) les pieds/socle sont encastrés de 5 cm sous le cadre et donc moins visibles.
With the insertion depth 18 cm the feet/socket are sunken in by 5 cm and this height less visible.

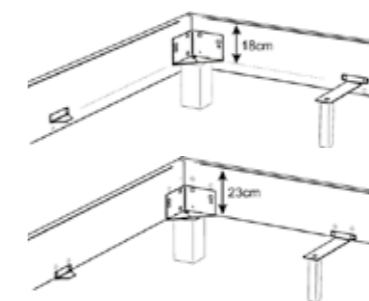

Option Midtraver-move

Achtung: nicht bei Füßen in der Höhe 30 cm, Lovie-Box und Practico-Box einsetzbar

Attention : ne s'applique pas aux pieds à une hauteur de 30 cm, Lovie-Box et Practico-Box
Attention: not applicable for feet at a height of 30 cm, Lovie-Box and Practico-Box

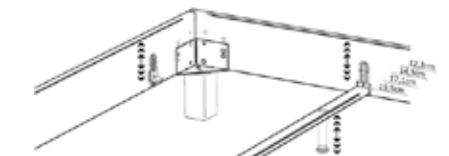

Modern, einzigartig, wertbeständig

Unsere Wood-Line ist ebenso langlebig wie das Holz, aus dem es gemacht ist und bietet Schlafkomfort auf hohem Niveau: modern, zeitlos und wertbeständig. Natürlich gewachsene Unregelmäßigkeiten in Farbe, Maserung und Oberfläche schenken dem massiven Holz und den Möbeln dieser Linie einen sehr natürlichen und einzigartigen Charakter.

Moderne, unique, de valeur stable

Le concept Wood-Line est aussi durable que le bois dont il est fait et offre un grand confort de sommeil : moderne, intemporel et durable. Les irrégularités naturelles de couleur, de grain et de surface donnent au bois massif et aux meubles de cette ligne un caractère très naturel et unique.

Modern, unique, stable in value

The Wood-Line concept is just as durable as the wood it is made of and offers a high level of sleeping comfort: modern, timeless and of lasting value. Naturally grown irregularities in colour, grain and surface give the solid wood and furniture of this line a very natural and unique character.

Füsse | Pieds | Feet

Holz | Bois | Wood



Lovie-Box
90–140 (1 Schublade/Tiroir/Drawer)



Lovie-Box
140–200 (2 Schubladen/Tiroirs/Drawers)



Standard: gedämpfter Selbsteinzug
Blumotion von BLUM
Option: Tip-On-Öffnung mit Vollauszug von BLUM

Standard: système d'amortissement
Blumotion de BLUM
Option: ouverture Tip-On avec sortie totale de BLUM

Standard: soft closing runner Blumotion of BLUM
Option: opening Tip-On with full extension of BLUM

Holz | Bois | Wood

	Masse cm Dim. cm	Breiten cm Largeurs cm Widths cm	Höhen cm Hauteurs cm Heights cm				Holzfarben Couleurs bois Colours wood												
			10	20	25	30	06	07	09	10	16	74	76	80					
Amigo*	10×10		14 cm																
Lana																			
Cantu	8×8																		
Evio		90–200																	
Ivio	10×10																		
Juve	8×8																		
Masi	6×5,5																		
Lovie-Box** (1 Schublade/Tiroir/Drawer)		90–140																	
Lovie-Box** (2 Schubladen/Tiroirs/Drawers)		140–200																	
Massa**	16×16																		
Practico-Box (inkl. Boden fond inclus bottom included)		90–200																	
Vilo		90–200																	

Practico-Box aus MDF ummantelt. Holzfüsse sind aus Massivholz | Practico-Box en mdf laminé. Pieds en bois massif | Practico-Box in mdf coated. Wooden feet are of solid wood.
*nur mit Classic 16 Rahmen möglich | uniquement possible avec cadre Classic 16 | only possible with frame Classic 16
**bei Premium 23 nur Einlegetiefe 23 cm möglich | pour Premium 23 uniquement possible avec hauteur encastrable de 23 cm | for Premium 23 only possible with insertion depth of 23 cm

06 Buche natur, lackiert Hêtre naturel, laqué Natural beech, lacquered	07 Buche schoko, lackiert Hêtre teinté chocolat, laqué Beech chocolate coloured, lacquered	09 Buche weiss lasiert, lackiert Hêtre teinté blanc lasuré, laqué Beech white stained, lacquered	10 Buche weiss deckend, lackiert Hêtre blanc couvrant, laqué Beech white covered, lacquered	16 Buche anthracit deckend, lackiert Hêtre anthracite couvrant, laqué Beech anthracite covered, lacquered
74 Eiche bright, geölt Chêne bright, huilé Oak bright, oiled	76 Eiche brandy, geölt Chêne brandy, huilé Oak brandy, oiled	80 Kernbuche natur, geölt Hêtre coeur rouge naturel, huilé Heart beech natural, oiled		

Füsse | Pieds | Feet

Metall | Métal | Metal



Metall Métal Metal	Masse cm Dim. cm	Breiten cm Largeurs cm Widths cm	Höhen cm Hauteurs cm Heights cm				Metallfarben Couleurs métal Colours metal													
			10	20	25	30	00	04	10	16	40	41	42	43	45					
Caro	6×6																			
Cielo [▲]		120–200																		
Facil																				
Fasio	Ø 5/9																			
Indus	6×2	140–200																		
Jeno	12×5																			
Mico	8×8																			
Quada	20×6,5																			
Reca	24×12																			
Road*	Ø 13																			
Slid	8/1	140–200																		
Soko	Ø 6																			
Stomp	Ø 8																			
Tondo	Ø 3,5																			

* Füsse fixiert, Rollen nur optisch | Pieds fixes, roulettes uniquement décoratives | Feet fixed, castors only visual
[▲] Curty Vorhang und Vela Baldachin-Tuch siehe Register 2, Seite 12 | Curty rideau et Vela tissu de baldaquin voir registre 2, page 12 | Curty curtain and Vela canopy cloth see index 2, page 12



00 Chrom = Edelstahl poliert | Acier poli | Stainless steel polished
04 Used = Stahl galvanisiert | Acier galvanisé | Steel galvanised
10 White = Stahl pulverbeschichtet | Acier thermolaqué | Steel powder-coated
16 Anthracit = Stahl pulverbeschichtet | Acier thermolaqué | Steel powder-coated
40 Bronze = Stahl lackiert | Acier laqué | Steel lacquered
41 Copper = Stahl lackiert | Acier laqué | Steel lacquered
42 Alu = Stahl pulverbeschichtet | Acier thermolaqué | Steel powder-coated
43 Inox = Edelstahl geschliffen | Acier poncé | Stainless steel ground
45 Iron = Stahl geflammt, pulverbeschichtet | Acier flammé, thermolaqué | Steel mottled, powder-coated

Bettkasten mit Holzkufe | Tiroirs de lit avec patins en bois | Bed drawers with wooden vat

Lovie-Box + Covero
90-140 cm 1 Schublade | 1 Tiroir | 1 Drawer

Stauraum | Compartiment de rangement | Storage space: 134 × 61 × 16 cm



Lovie-Box + Saceto
140-200 cm 2 Schubladen | 2 Tiroirs | 2 Drawers

Stauraum | Compartiment de rangement | Storage space: 2 × 134 × 61 × 16 cm

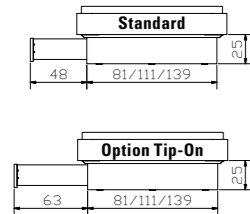

Standard: gedämpfter Selbsteinzug Blumotion von BLUM | système d'amortissement Blumotion de BLUM | soft closing runner Blumotion of BLUM
Option: Tip-On-Öffnung mit Vollauszug von BLUM | ouverture Tip-On avec sortie totale de BLUM | opening Tip-On with full extension of BLUM

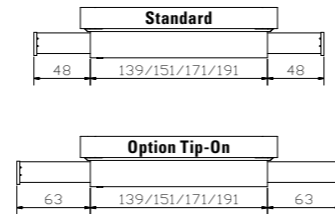

Roll-Box 20/25



Bettkasten in weiss oder anthrazit (Boden weiss)

Voraussetzung
Bettfusshöhe von mindestens 20cm erforderlich

Optionen
Deckel Covero in weiss, Stoffabdeckung Saceto in Polyester grau.

Roll-Box 20/25 + Cover



Tiroir de lit en blanc ou anthracite (fond blanc)

Condition préalable
Une hauteur de pieds de lit d'au moins 20 cm est nécessaire

Options
Couvercle Covero en blanc, tissu de protection Saceto en polyester gris.

Roll-Box 20/25 + Saceto



Bed drawer in white or anthracite (bottom white)

Condition
Feet of bed need a minimum height of 20 cm

Options
Cover Covero in white, tissue of protection Saceto in polyester grey.

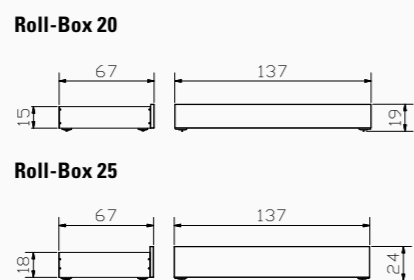

Stauraum Espace de rangement Storage space	
Roll-Box 20	= 134 × 61 × 13 cm
Roll-Box 25	= 134 × 61 × 16 cm

Bettkasten | Coffres à literie | Bedding boxes

Practico-Box + Classic 16
+ Ultrafree-Lift KF



Ultrafree-Lift KF

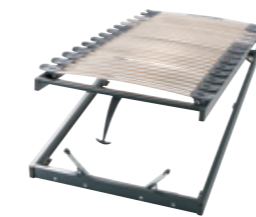

Box = inkl. Boden, Anwendung siehe Seiten 6.40/41
zu Practico-Box:
Lattenrost **Ultrafree-Lift KF**
Kopf-/Fussverstellung
Rahmenholme Höhe 7 cm und 28 Federleisten aus Buchenschichtholz
Gesamthöhe 11 cm

Lattenrost **Econom-move**
Unverstellbar
Rahmenholme Höhe 6 cm und 28 Federleisten aus Buchenschichtholz
Gesamthöhe 9 cm

inkl. Gasdruckfedern und allen Beschlägen

Details zu Ultrafree-Lift KF und Econom-move
siehe Register 14, Seite 14.8

Practico-Box + Premium 23
+ Econom-move



Econom-move



Box = fond inclus, utilisation voir pages 6.40/41
pour box Practico:
Sommier **Ultrafree-Lift KF**
Tête et pied réglables
Cadre, hauteur 7 cm et 28 lattes en hêtre multiplis
Hauteur totale 11 cm

Sommier **Econom-move**
Non réglable
Cadre, hauteur 6 cm et 28 lattes en hêtre multiplis
Hauteur totale 9 cm

Pistons à gaz et toute la quincaillerie inclus

Détails pour Ultrafree-Lift KF et Econom-move
voir registre 14, page 14.8

Stauraum | Compartiment de rangement | Storage space

90 × 200/210/220	=	81 × 190/200/210 × 24 cm
100 × 200/210/220	=	91 × 190/200/210 × 24 cm
120 × 200/210/220	=	111 × 190/200/210 × 24 cm
140 × 200/210/220	=	131 × 190/200/210 × 24 cm
160 × 200/210/220	=	74 × 190/200/210 × 24 (2 x)
180 × 200/210/220	=	84 × 190/200/210 × 24 (2 x)
200 × 200/210/220	=	94 × 190/200/210 × 24 (2 x)

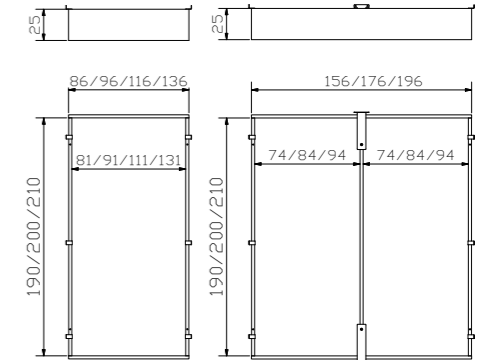

Box = bottom incl., handling see pages 6.40/41
for Practico-box:
Slats **Ultrafree-Lift KF**
Head/footpiece adjustable
Frame, height 7 cm and 28 slats are of beech veneer board
Total height 11 cm

Slats **Econom-move**
Not adjustable
Frame, height 6 cm and 28 slats are of beech veneer board
Total height 9 cm

Pneumatic compression spring and all fittings included

Details for Ultrafree-Lift KF and Econom-move
see index 14, page 14.8

Himmelbett ohne Grenzen

Lit à baldachin sans frontières | Canopy bed without borders

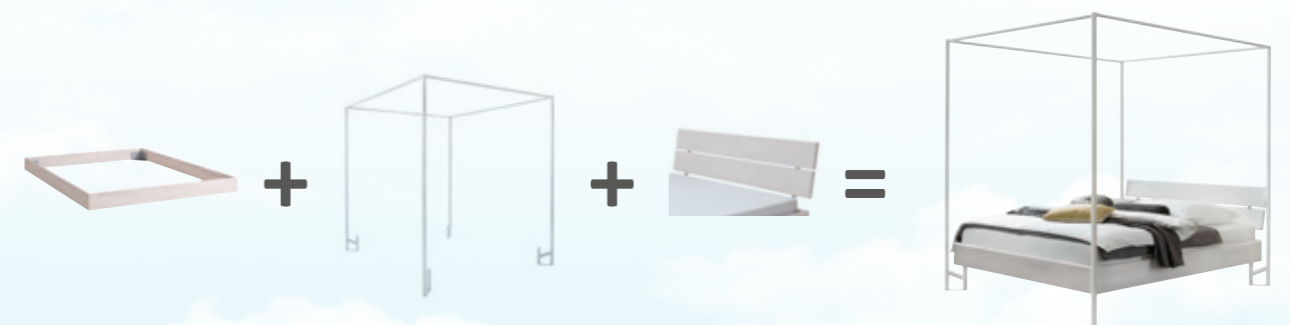

Betrahmen | Cadre de lit | Bedframe

Cielo
Baldachin | Baldachin | Canopy

Kopfteil | Tête de lit | Headboard

Kopfteile | Têtes de lit | Headboards



Dia



Dimension: 90/100, 120, 140, 160, 180/200

Lara

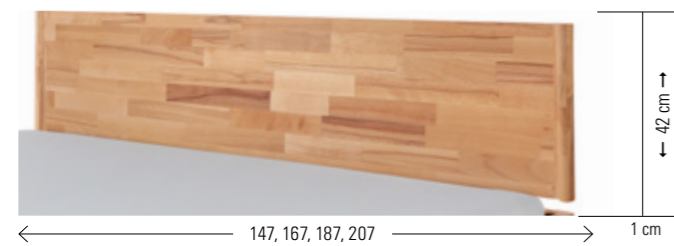

Dimension: 140, 160, 180, 200

Sandro



Dimension: 90/100, 120, 140, 160, 180, 200

Vola

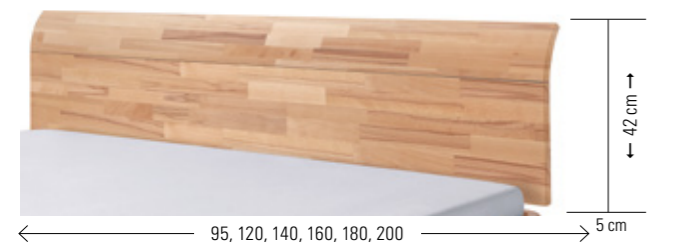

Dimension: 90/100, 120, 140, 160, 180, 200

Duetto



Dimension: 90/100, 120, 140, 160, 180, 200

Litto



Dimension: 140, 160, 180/200

Varus



Dimension: 140, 160, 180, 200

Kopfteil | Têtes de lit | Headboard

Holzfarben

Couleurs bois
Colours wood

	06	07	09	74	76	80
Dia	●	●	●	●	●	●
Duetto	●	●	●	●	●	●
Litto	●	●	●	●	●	●
Lara	●	●	●	●	●	●
Sandro	●	●	●	●	●	●
Varus	●	●	●	●	●	●
Vola	●	●	●	●	●	●

Holz | Bois | Wood

 06 Buche natur, lackiert Hêtre naturel, laqué Natural beech, lacquered	 07 Buche schoko, lackiert Hêtre teinté chocolat, laqué Beech chocolate coloured, lacquered	 09 Buche weiss lasiert, lackiert Hêtre teinté blanc lasuré, laqué Beech white stained, lacquered	 74 Eiche bright, geölt Chêne bright, huilé Oak bright, oiled	 76 Eiche brandy, geölt Chêne brandy, huilé Oak brandy, oiled	 80 Kernbuche natur, geölt Hêtre cœur rouge naturel, huilé Heart beech natural, oiled
---	---	---	---	---	---

Kissen zu Kopfteilen | Coussins pour têtes de lit | Cushions for headboards

Arona + Duetto



Ravo + Varus



Varo + Varus



Lumo + Duetto



Suny + Litto



Befestigung mit 2 Bändern (Klettverschluss)

Fixation avec 2 bandes (Velcro®)
Fixation with 2 ribbons (Velcro®fastener)

Stoffauswahl/Farben für Kissen siehe Register 1, Seiten 6–7

Choix de tissus/couleurs pour coussins voir registre 1, pages 6–7
Choice of tissues/colours for cushions see index 1, pages 6–7

Gepolsterte Kopfteile, Wandpaneele, Stoffauswahl/Farben siehe Register 1, Leselampen siehe Register 2.

Têtes de lits rembourrées, panneaux muraux, choix de tissus/couleurs voir registre 1, lampes de lecture voir registre 2.
Upholstered headboards, wallpanels, choice of tissues/colours see index 1, reading lamps see index 2.

Kissen | Coussins | Cushions

	Effektive Masse cm Dimensions effectives cm Effective dimensions cm
Arona	86, 116, 136, 156, 176×3,5×25
Lumo	86, 116, 136, 156, 176×6×25
Suny (2er Set set de 2 set of 2)	55×6×40
Ravo	80, 110, 130, 150, 170, 190×3,5×35
Varo (2er Set set de 2 set of 2)	55×10×35

zu Kopfteilen

pour têtes de lit
for headboards

	Duetto	Dia	Lara	Litto	Varus
Arona	●	●			
Lumo	●	●			
Suny (2er Set set de 2 set of 2)	●	●	●	●	●
Ravo	●	●	●	●	●
Varo (2er Set set de 2 set of 2)	●	●		●	●

Breitenmasse cm

Dimensions de largeur cm
widths dimensions cm

Arona	90/100, 120, 140, 160, 180/200
Lumo	90/100, 120, 140, 160, 180/200
Suny (2er Set set de 2 set of 2)	90/100, 120, 140, 160, 180, 200
Ravo	90/100, 120, 140, 160, 180, 200
Varo (2er Set set de 2 set of 2)	90/100, 120, 140, 160, 180, 200

Adapter | Adaptateur | Adapter

Bei hohen Matratzen kann mit dem Verlängerungsadapter das Kopfteil um 9 oder 13 cm erhöht werden.

La tête de lit peut être rehaussée de 9 ou 13 cm avec l'adaptateur quand le matelas est plus épais.

With the extension adapter the headboard can be extended 9 or 13 cm if mattresses are high.

Alu für alle Holzfarben, ausser 74 und 76. Black für Holzfarben 74 und 76.

Alu pour toutes les couleurs de bois, sauf 74 et 76. Black pour les couleurs de bois 74 et 76.

Alu for all wood colours except 74 and 76. Black for wood colours 74 and 76.

Head-Plus Metall | Métal | Metal

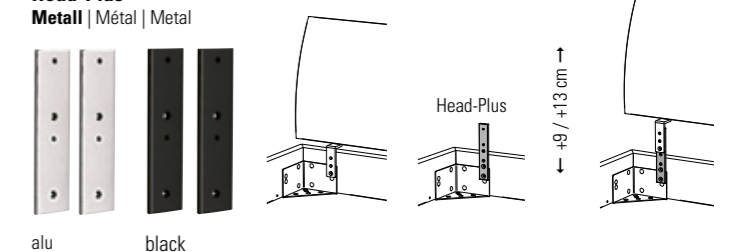

alu

black

Beimöbel | Accessoires | Accessories

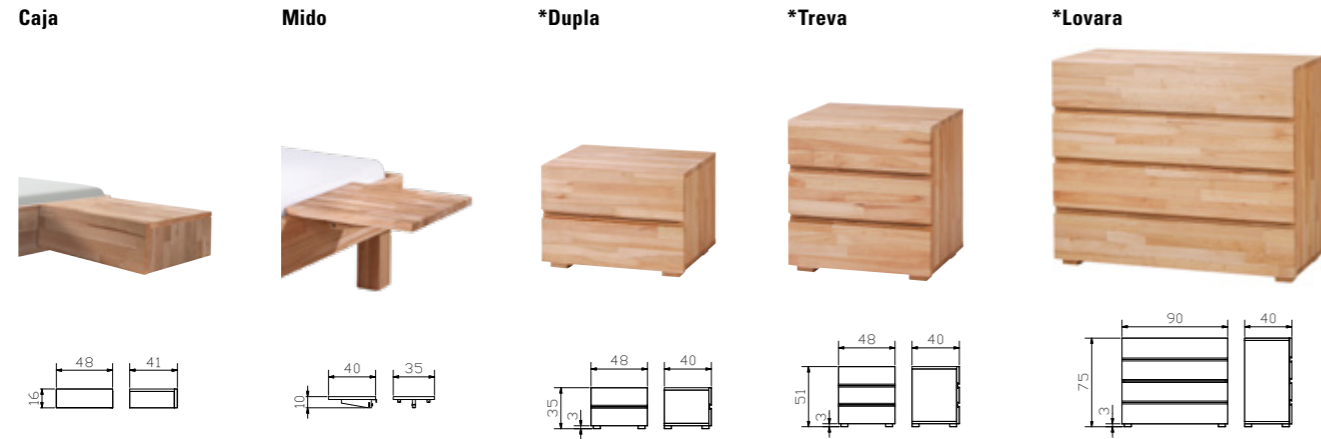

Holz | Bois | Wood

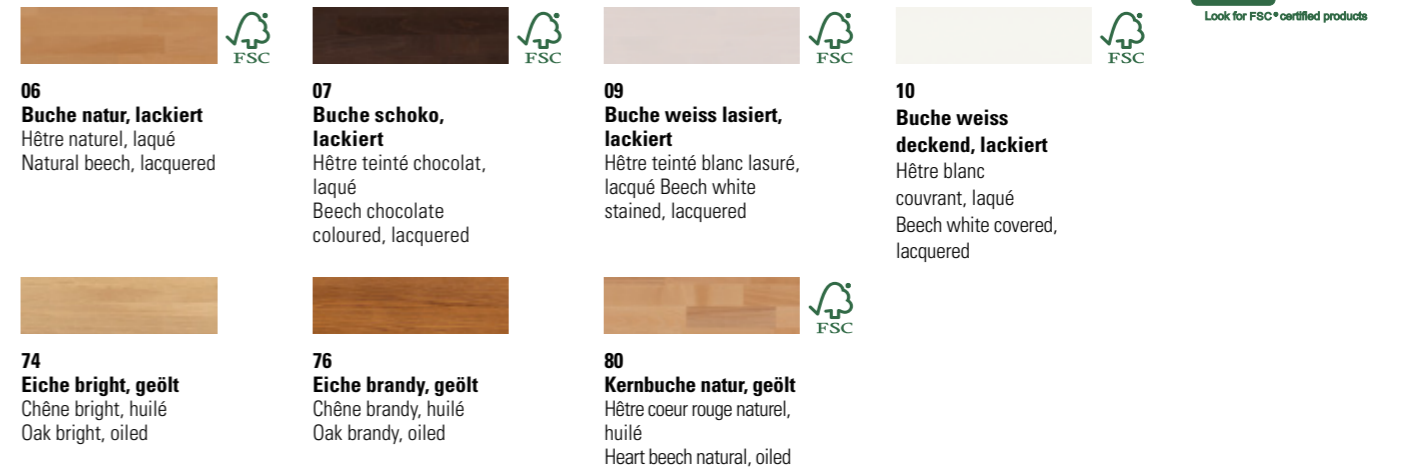

Bank + Kissen | Banquette + Coussin | Bench + Cushion



Herrendiener | Valet | Dressboy

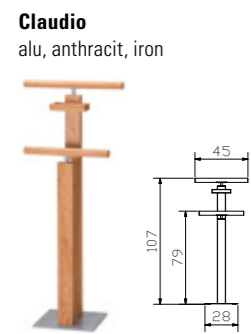

Sekretär | Secrétaire | Bureau

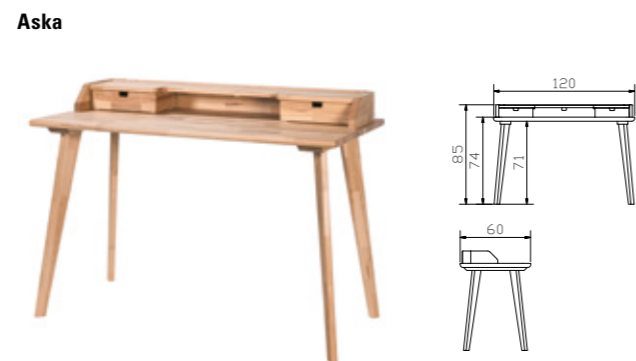

Füsse | Pieds | Feet



Fuss Set (4 Stk.) | Set de pieds (4 pcs) | Set of feet (4 pcs)
Fuss passend zu Dupla, Treva und Lovara | Pied adapté à Dupla, Treva et Lovara | Foot suitable for Dupla, Treva and Lovara

	Holzfarben Couleurs bois Colours wood							Metallfarben Füsse Couleurs métal pieds Colours metal feet			
	06	07	09	10	74	76	80	04	16	42	45
Aska				●			●				
Caja	●	●	●		●	●	●				
Cila								●			
Claudio				●	●	●	●		●	●	●
Dupla	●	●	●		●	●	●				
Jone								●	●		
Leg										●	
Lovara	●	●	●		●	●	●				
Mido	●	●	●		●	●	●				
Sola				●	●	●	●				
Treva	●	●	●		●	●	●				



selezione

01

MODELLAUSWAHL

Sélection du modèle | Model selection

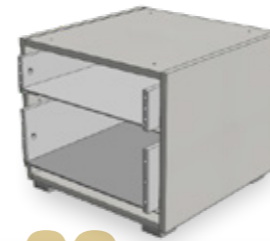
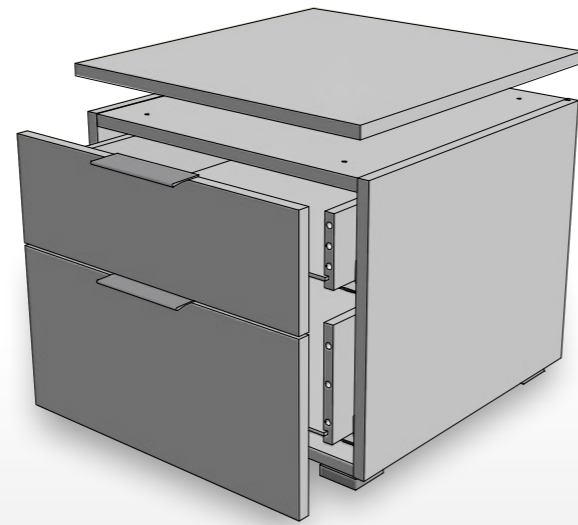

02

KORPUS

Caisson | Body



03

TOP/FRONT

Farben | Couleurs | Colours

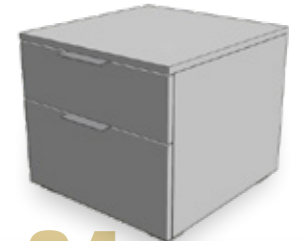

04

GRIFFE

Poignées | Handles

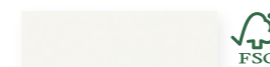
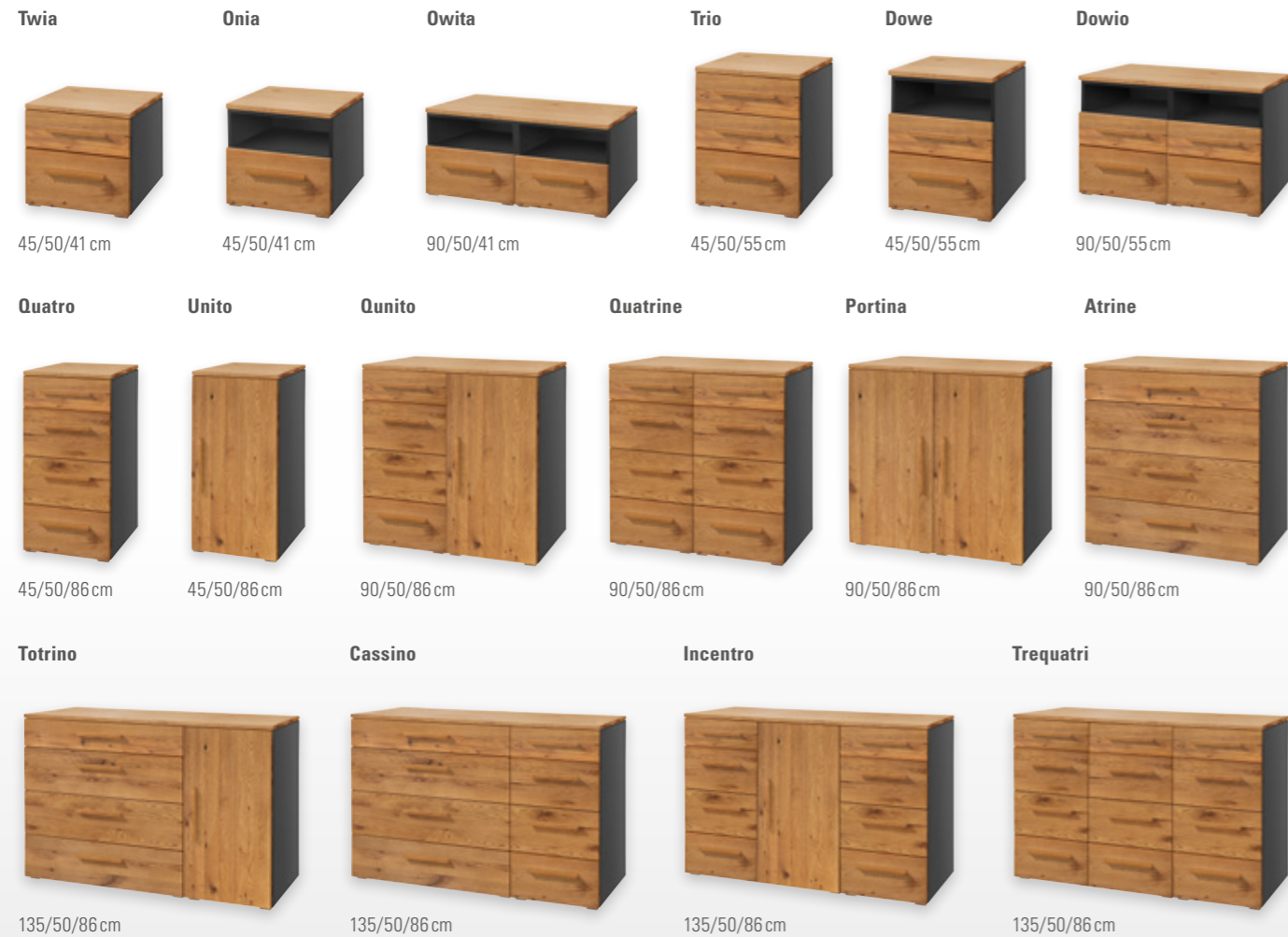

10 Weiss | Blanc | White



16 Anthracit | Anthracite

+ FÜSSE

Pieds | Feet

STANDARD



OPTION

Leg 8 cm



alu

Jone 10 cm



anthracit
used

Cila 10 cm



anthracit

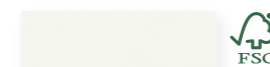

10 Weiss | Blanc | White



16 Anthracit | Anthracite

STANDARD



Alu

Griff zu Folienfronten

Poignée pour façades en mélaminé
Handle for foil fronts



74 Eiche bright, geölt
Chêne bright, huilé
Oak bright, oiled

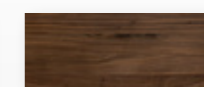

82 Nussbaum, geölt
Noyer, huilé
Walnut, oiled

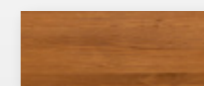

76 Eiche brandy, geölt
Chêne brandy, huilé
Oak brandy, oiled



87 Wildbuche natur, geölt
Hêtre nouveau naturel, huilé
Wildbeech natural, oiled



80 Kernbuche natur, geölt
Hêtre coeur rouge
naturel, huilé
Heart beech natural, oiled



99 Wildeiche natur, geölt
Chêne nouveau naturel, huilé
Wildoak natural, oiled

STANDARD



Holzgriff zu Holzfronten

Poignée en bois pour façades en bois
Wooden handle for wooden fronts

OPTION

Rivo



Used



Anthracit

Metallgriff zu Holzfronten

Poignée en métal pour façades en bois
Metal handle for wooden fronts

Stellen Sie sich Ihr Wunsch-Beimöbel nach Ihrem Geschmack zusammen: Der Korpus (Abb. 02), in zwei verschiedenen Farbvarianten, lässt sich zu den Front- und Top-Covern (Abb. 03) in acht Holz- und Farbausführungen kombinieren. Die Beimöbel können zerlegt oder teilmontiert bestellt werden. Bei zusammengesetzten Möbeln (z. B. Qunito, Incentro, ...) muss der Deckel noch montiert werden. Bei Kommoden mit Türen ist jeweils ein Einlegeboden vorhanden, Türöffnung nach links oder rechts möglich. Zusätzliche Böden sind erhältlich.

Composez le meuble d'appoint de vos rêves selon vos goûts : Le caisson (ill. 02), disponible en 2 variantes de couleurs, peut être combiné avec les façades et couvercles supérieurs (ill. 03) en 8 finitions de bois et de coloris. Les meubles d'appoint peuvent être commandés en kits ou assemblés. Pour les meubles assemblés (p. ex. Qunito, Incentro, ...) le couvercle doit encore être fixé. Les commodes avec portes sont équipées d'une étagère, ouverture de la porte possible à gauche ou à droite. Si besoin, des étagères supplémentaires sont disponibles.

Put together the side furniture you want according to your own taste: The body (fig. 02), in two different colour versions, can be combined with the front and top covers (fig. 03) in eight wood and colour versions. The furniture can be ordered disassembled or assembled. For assembled furniture (e.g. Qunito, Incentro, ...) the top cover must still be fitted. Chests of drawers with doors have one shelf, door opening possible to the left or right. Additional shelves are available.



Kombinationsbeispiele
und techn. Informationen
Exemples et informations
Examples and informations



Lattenroste | Sommier | Slats



Dritto U

U = Unverstellbar
Non réglable
Not adjustable

Rahmenholme und 14 Federleisten aus Buchenschichtholz
Cadre et 14 lattes en hêtre multiplis
Frame and 14 slats are of beech veneer board

Starre Lagerung
Suspension rigide
Rigid suspension

Längen | Longueurs | Lengths

190

200

Höhe | Hauteur | Height: 6 cm

Keine Sondermasse möglich | Dimensions spéciales non disponibles |
No special sizes possible

Breiten | Largeurs | Widths

80	90	100	120	140
	●			●
●	●	●	●	●



Flexo K

K = Kopfteil manuell 13-fach verstellbar
Réglage manuel de la tête en 13 positions
Head piece manually adjustable in 13 positions

Rahmenholme und 28 Federleisten aus Buchenschichtholz
Cadre et 28 lattes en hêtre multiplis
Frame and 28 slats are of beech veneer board

Flexible Lagerung
Suspension flexible
Flexible suspension

Schulterkomfortzone
Zone de confort des épaules
Comfort zone for shoulders

Mittelzonenverstärkung
Zone médiane renforcée
Reinforcement of the middle zone



Längen | Longueurs | Lengths

190

200, 210, 220

Höhe | Hauteur | Height: 9 cm

Keine Sondermasse möglich | Dimensions spéciales non disponibles |
No special sizes possible

Breiten | Largeurs | Widths

80	90	100	120	140
	●			●
●	●	●	●	●



Ultrafree RF

RF = Rücken- und Fussteil manuell je 13-fach verstellbar
Réglage manuel pour le haut du corps et les jambes en 13 positions
Back and foot sections manually adjustable in 13 positions

Rahmenholme und 30 Federleisten aus Buchenschichtholz
Cadre et 30 lattes en hêtre multiplis
Frame and 30 slats are of beech veneer board

Details siehe Seite 13.2–13.3
Détails voir page
Details see page: 13.2–13.3

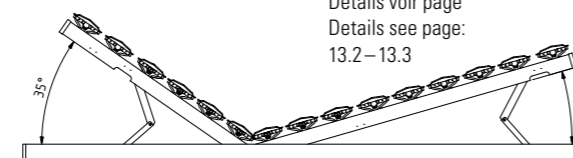

Längen | Longueurs | Lengths

190

200, 210, 220

Höhe | Hauteur | Height: 10 cm

Keine Sondermasse möglich | Dimensions spéciales non disponibles |
No special sizes possible

Breiten | Largeurs | Widths

80	90	100	120	140
●	●	●	●	●
●	●	●	●	●

Matratzen | Matelas | Mattresses

Novo

7-Zonen-Kaltschaumkern, Höhe 8 cm in Härtegrad H3 (RG 35) erhältlich
7-zones noyau en mousse froide, hauteur 8 cm disponible dans le degré de fermeté f3 (densité 35)
7-zones core cold foam, height 8 cm available in the degree of hardness H3 (density 35)

Optimale Unterstützung durch 7-Zonen-Kaltschaum-Noppenprofil in 2.5 cm Stärke
Soutien optimal grâce à une mousse 7-zones froide à picots 2.5 cm
Optimum support through 7-zones cold foam upholstery 2.5 cm with nobs

Breiten | Largeurs | Widths 80, 90, 100, 120, 140, 160, 180, 200 cm

Längen | Longueurs | Lengths 200, 210, 220 cm

Höhe | Hauteur | Height 16 cm

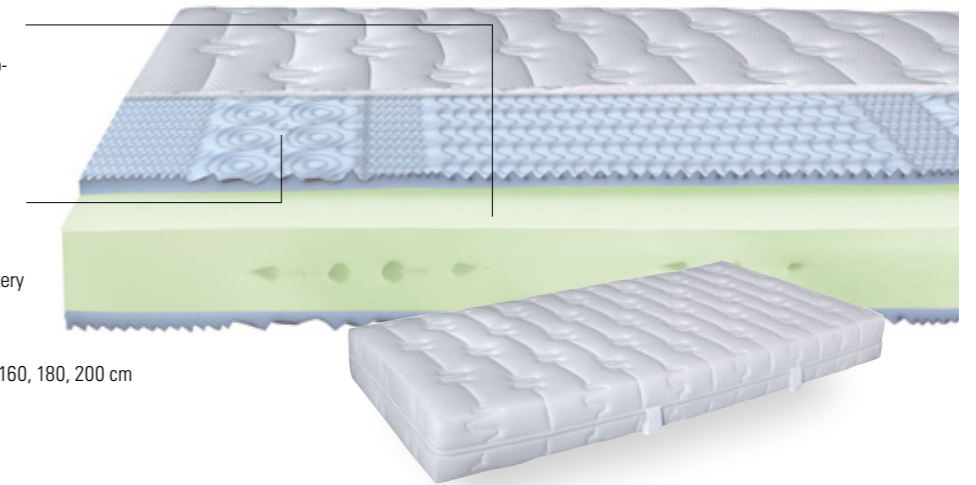

Ultraconfort

7-Zonen-Kaltschaumkern, Höhe 12 cm in den Härtegraden H3 (RG 45) und H4 (RG 50) erhältlich
7-zones noyau en mousse froide, hauteur 12 cm disponible dans les degrés de fermeté f3 (densité 45) et f4 (densité 50)
7-zones core cold foam, height 12 cm available in the degrees of hardness H3 (density 45) and H4 (density 50)

Optimale Unterstützung und Klimatisierung durch 4 cm Soft-Kaltschaum-Auflage RG 60
Soutien optimal et climatisation idéale grâce à une mousse froide souple 4 cm densité 60
Optimum support and climate regulation through 4 cm soft cold foam upholstery density 60

Breiten | Largeurs | Widths 80, 90, 100, 120, 140, 160, 180, 200 cm

Längen | Longueurs | Lengths 190, 200, 210, 220 cm

Höhe | Hauteur | Height 21 cm

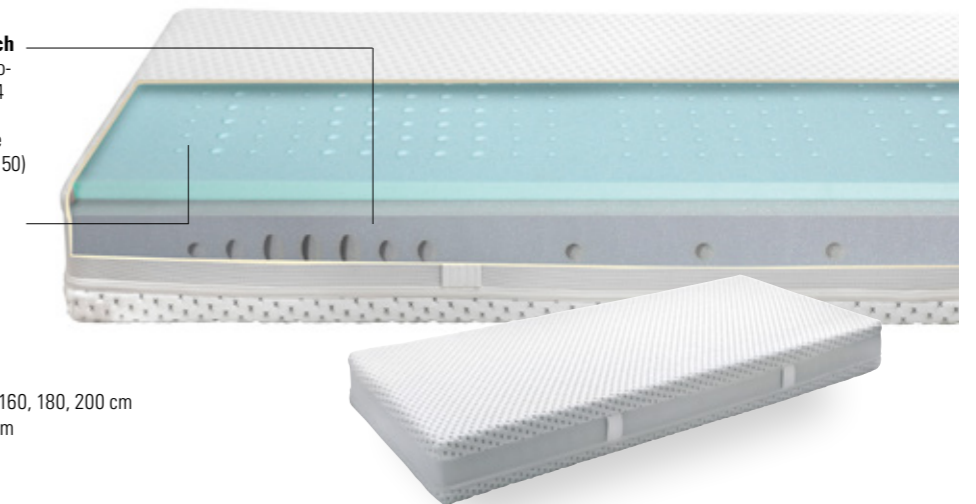

Ultramotion

7-Zonen-Kaltschaum-Tröpfchenkern mit Querbelüftung und Schulterzone, Höhe 20 cm in den Härtegraden H2 (RG 53), H3 (RG 53) und H4 (RG 45) erhältlich

7-zones noyau de gouttelettes en mousse froide avec ventilation transversale et zone pour les épaules, hauteur 20 cm disponible dans les degrés de fermeté f2 (densité 53), f3 (densité 53) et f4 (densité 45)
7-zones cold foam droplet core with lateral ventilation and shoulder zone, height 20 cm available in the degrees of hardness H2 (density 53), H3 (density 53) and H4 (density 45)

Breiten | Largeurs | Widths 80, 90, 100, 120, 140, 160, 180, 200 cm

Längen | Longueurs | Lengths 190, 200, 210, 220 cm

Höhe | Hauteur | Height 23 cm

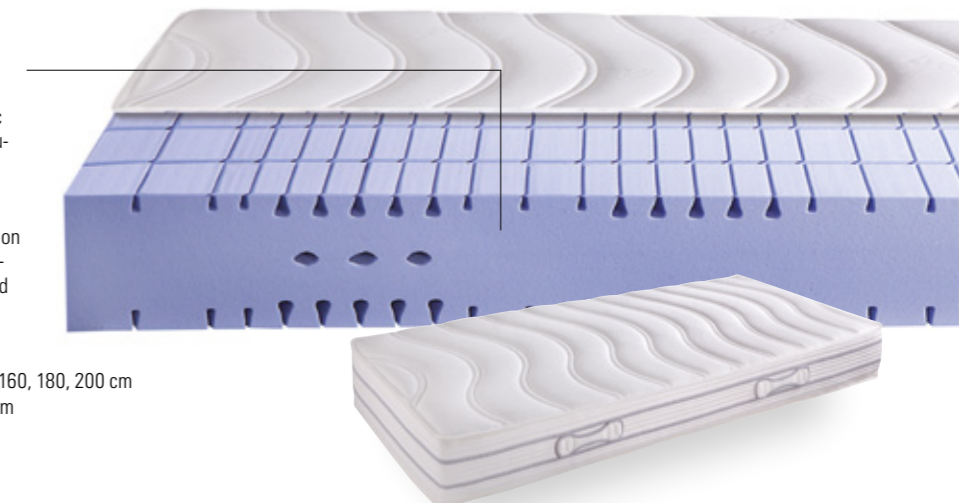

Informationen zu Matratzenbezügen und weitere Lattenroste und Matratzen siehe Register 13

Informations sur les housses de matelas et autres sommier et matelas, voir registre 13
Information on mattress covers and other slatted frames and mattresses, see tab 13.



				Dimension cm
Lovara	Kommode	Commode	Chest of drawers	90/40/75
Dupla	Nachttisch	Table de nuit	Bedside table	48/40/35

				Dimension cm
Classic 16	Rahmen Breiten Längen	Cadre Largeurs Longueurs	Frame Widths Lengths	90, 100, 120, 140, 160, 180, 200 190, 200, 210, 220
Masi	Füße Höhen	Pieds Hauteurs	Feet Heights	20, 25
Boga	Kopfteil, Campos blanc 372 siehe Register 1	Tête de lit, Campos blanc 372 voir registre 1	Headboard, Campos blanc 372 see index 1	90, 100, 120, 140, 160, 180, 200

Alle Holzteile in Kernbuche natur, geölt | Toutes les parties en bois en hêtre cœur rouge naturel, huilé | All wooden parts in heart beech natural, oiled
 Weitere Beimöbel siehe Register 2 | Autres accessoires voir registre 2 | Further accessories see index 2

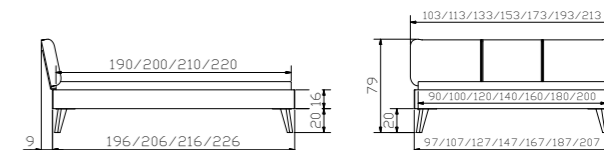



	Dimension cm			
Lovie-Box	1 Bettkasten Breiten	1 Tiroir de lit Largeurs	1 Bed drawer Widths	90, 100, 120, 140
	2 Bettkästen Breiten	2 Tiroirs de lit Largeurs	2 Bed drawers Widths	140, 160, 180, 200
	Höhe	Hauteur	Height	25

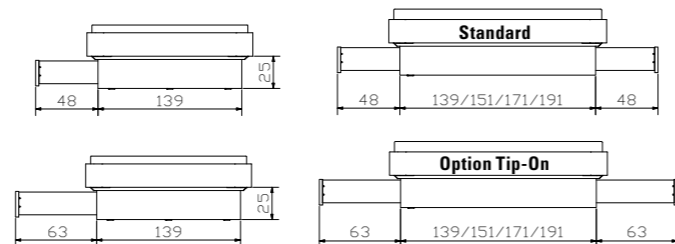

	Dimension cm			
Classic 16	Rahmen Breiten Längen	Cadre Largeurs Longueurs	Frame Widths Lengths	140, 160, 180, 200 190, 200, 210, 220
Indus iron	Kufen Breiten Höhen	Patins Largeurs Hauteurs	Vats Widths Heights	140, 160, 180, 200 20, 25
Elipsa	Kopfteil, Casual cannelle 331 siehe Register 1	Tête de lit, Casual cannelle 331 voir registre 1	Headboard, Casual cannelle 331 see index 1	140, 160, 180, 200
Caja	Nachttisch	Table de nuit	Bedside table	48/41/16
Aska	Sekretär	Secrétaire	Bureau	120/60/85

Alle Holzteile in Kernbuche natur, geölt | Toutes les parties en bois en hêtre cœur rouge naturel, huilé | All wooden parts in heart beech natural, oiled
Weitere Beimöbel siehe Register 2 | Autres accessoires voir registre 2 | Further accessories see index 2

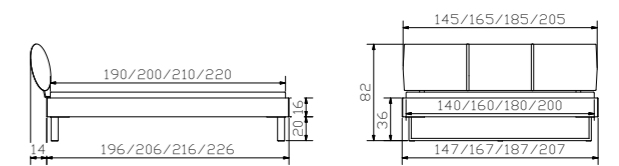



				Dimension cm
Varus	Kopfteil	Tête de lit	Headboard	140, 160, 180, 200
Duetto	Kopfteil	Tête de lit	Headboard	90/100, 120, 140, 160, 180, 200
Arona	Kissen, Kitana grigio 602	Coussin, Kitana grigio 602	Cushion, Kitana grigio 602	90/100, 120, 140, 160, 180/200

				Dimension cm
Classic 16	Rahmen Breiten Längen	Cadre Largeurs Longueurs	Frame Widths Lengths	90, 100, 120, 140, 160, 180, 200 190, 200, 210, 220
Juve	Füße Höhen	Pieds Hauteurs	Feet Heights	20, 25
Dia	Kopfteil	Tête de lit	Headboard	90/100, 120, 140, 160, 180/200
Mido	Nachttisch	Table de nuit	Bedside table	40/35/10

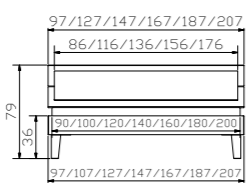
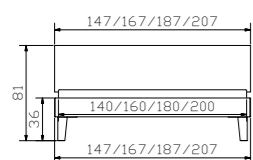

Alle Holzteile in Kernbuche natur, geölt | Toutes les parties en bois en hêtre cœur rouge naturel, huilé | All wooden parts in heart beech natural, oiled
Weitere Beimöbel siehe Register 2 | Autres accessoires voir registre 2 | Further accessories see index 2

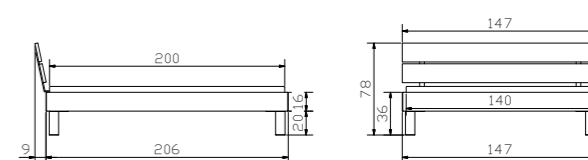



				Dimension cm
Ronna	Kopfteil, Capo rose 762	Tête de lit, Capo rose 762	Headboard, Capo rose 762	90/100, 120, 140, 160, 180, 200
Duetto	Kopfteil	Tête de lit	Headboard	90/100, 120, 140, 160, 180, 200
Arona	Kissen, Capo rose 762	Coussin, Capo rose 762	Cushion, Caop rose 762	90/100, 120, 140, 160, 180/200
Caja	Nachttisch	Table de nuit	Bedside table	48/41/16

				Dimension cm
Classic 16	Rahmen Breiten Längen	Cadre Largeurs Longueurs	Frame Widths Lengths	90, 100, 120, 140, 160, 180, 200 190, 200, 210, 220
Cantu	Füsse Höhen	Pieds Hauteurs	Feet Heights	20, 25, 30
Duetto	Kopfteil	Tête de lit	Headboard	90/100, 120, 140, 160, 180, 200
Lumo	Kissen, Capo rose 762	Coussin, Capo rose 762	Cushion, Capo rose 762	90/100, 120, 140, 160, 180/200
Onia	Nachttisch	Table de nuit	Bedside table	45/49/40
Dowio	Kommode	Commode	Chest of drawers	90/49/55
Roll-Box 20 + Covero	Bettkasten Deckel Covero in weiss	Tiroir de lit Couvercle Covero en blanc	Bed drawer Covero in white	137/67/19

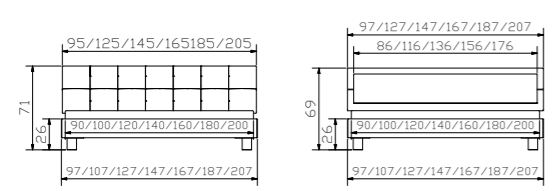

Alle Holzteile in Buche weiss lasiert, lackiert oder weiss | Toutes les parties en bois en hêtre teinté blanc lasuré, laqué ou blanc | All wooden parts in beech white stained, lacquered or white
Weitere Beimöbel siehe Register 2 | Autres accessoires voir registre 2 | Further accessories see index 2

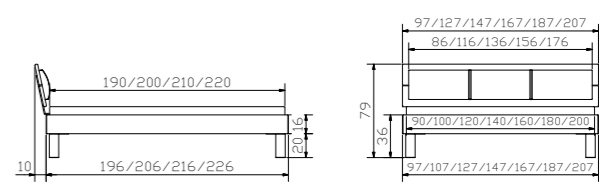



				Dimension cm
Lovara	Kommode	Commode	Chest of drawers	90/40/75
Treva	Nachttisch	Table de nuit	Bedside table	48/40/51

				Dimension cm
Classic 16	Rahmen Breiten Längen	Cadre Largeurs Longueurs	Frame Widths Lengths	90, 100, 120, 140, 160, 180, 200 190, 200, 210, 220
Massa	Füße Höhen	Pieds Hauteurs	Feet Heights	20, 25, 30
Litto	Kopfteil	Tête de lit	Headboard	140, 160, 180/200

Alle Holzteile in Buche weiss lasiert, lackiert | Toutes les parties en bois en hêtre teinté blanc lasuré, laqué | All wooden parts in beech white stained, lacquered
Weitere Beimöbel siehe Register 2 | Autres accessoires voir registre 2 | Aurther accessories see index 2

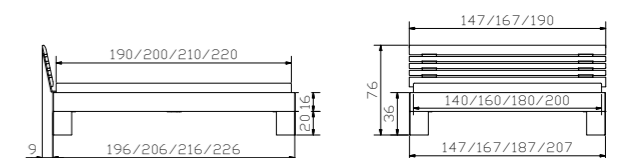





				Dimension cm
Dupla	Nachttisch	Table de nuit	Bedside table	48/40/35

				Dimension cm
Classic 16	Rahmen Breiten Längen	Cadre Largeurs Longueurs	Frame Widths Lengths	90, 100, 120, 140, 160, 180, 200 190, 200, 210, 220
Cantu	Füße Höhen	Pieds Hauteurs	Feet Heights	20, 25, 30
Duetto	Kopfteil	tête de lit	Headboard	90/100, 120, 140, 160, 180, 200

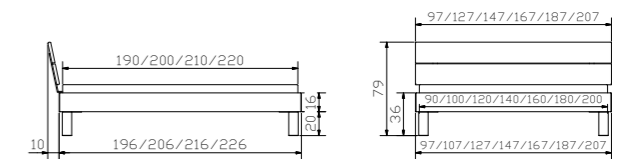
Alle Holzteile in Buche natur, lackiert | Toutes les parties en bois en hêtre naturel, laqué | All wooden parts in natural beech, lacquered
Weitere Beimöbel siehe Register 2 | Autres accessoires voir registre 2 | Further accessories see index 2





				Dimension cm
Topa anthracit	Bank inkl. Kissen Fusio musk 752	Banquette, coussin incl. Fusio musk 752	Bench, cushion incl. Fusio musk 752	144/44/38
Twia	Nachttisch	Table de nuit	Bedside table	45/49/40
Smart black	Leselampe (2er Set) 12V DC, 30 LED warm	Lampe de lecture (set de 2) 12V DC, 30 LED warm	Reading lamp (set of 2) 12V DC, 30 LED warm	

				Dimension cm
Classic 16	Rahmen Breiten Längen	Cadre Largeurs Longueurs	Frame Widths Lengths	90, 100, 120, 140, 160, 180, 200 190, 200, 210, 220
Tondo anthracit	Füße Höhe	Pieds Hauteur	Feet Height	20
Lecco	Kopfteil, Fusio musk 752 siehe Register 1	Tête de lit, Fusio musk 752 voir registre 1	Headboard, Fusio musk 752 see index 1	90/100, 120, 140, 160, 180/200

Alle Holzteile in Buche schoko, lackiert oder anthracit | Toutes les parties en bois en hêtre teinté chocolat, laqué ou anthracite | All wooden parts in beech chocolate, lacquered or anthracite

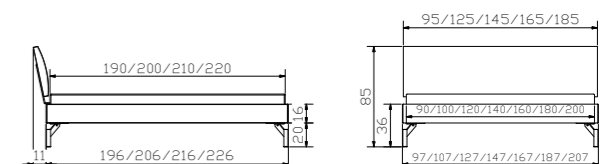

Leselampen und weitere Beimöbel siehe Register 2 | Lampes de lecture et autres accessoires voir registre 2 | Reading lamps and further accessories see index 2





			Dimension cm
Amigo	 Stapelbett (ohne Lattenrost)	lit superposable (sans sommier)	stacking bed (without slats)
		Breite largeur	width largeur
		Länge longueur	length longueur
	Unterbett: Freiraum für Lattenroste und Matratzen 26 cm	lit inférieur : espace libre pour sommiers et matelas 26 cm	lower bed: free space for slats and mattresses 26 cm

Alle Holzteile in Buche weiss lasiert, lackiert | toutes les parties en bois en hêtre teinté blanc lasuré, laqué | all wooden parts in beech white stained, lacquered

			Dimension cm
Amigo	 Einzelbett	lit simple	single bed
		Breite largeur	width largeur
		Länge longueur	length longueur
Dupla	 Nachttisch	table de nuit	bedside table
			48/40/35

Alle Holzteile in Kernbuche natur, geölt | toutes les parties en bois en hêtre coeur rouge nature, huilé | all wooden parts in Heart beech natural, oiled
Weitere Beimöbel siehe Register 2 | autres accessoires voir registre 2 | further accessories see index 2

Ausführungen | Exécutions | Executions

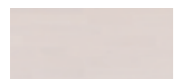

09
Buche weiss, lasiert, lackiert
 Hêtre teinté blanc lasuré, laqué
 Beech white stained, lacquered



80
Kernbuche natur, geölt
 Hêtre coeur rouge naturel, huilé
 Heart beech natura, oiled

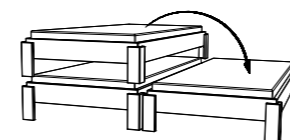
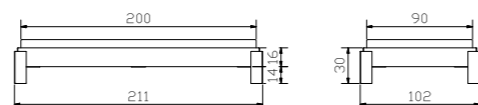

stapelbar | superposable | stackable

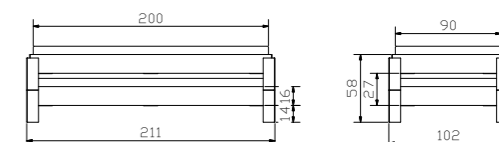





				Dimension cm
Dupla	Nachttisch	Table de nuit	Bedside table	48/40/35
Sola	Bank	Banquette	Bench	144/44/38
Claudio anthracit	Herrendiener	Valet	Dressboy	45/28/107

				Dimension cm
Premium 18	Rahmen Breiten Längen	Cadre Largeurs Longueurs	Frame Widths Lengths	90, 100, 120, 140, 160, 180, 200 200, 210, 220
Slid anthracit	Füße Höhen	Pieds Hauteurs	Feet Heights	20, 25
Sandro	Kopfteil	Tête de lit	Headboard	90/100, 120, 140, 160, 180, 200

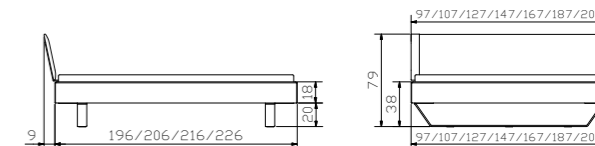
Alle Holzteile in Eiche brandy, geölt | Toutes les parties en bois en chêne brandy, huilé | All wooden parts in oak brandy, oiled
Weitere Beimöbel siehe Register 2 | Autres accessoires voir registre 2 | Further accessories see index 2





				Dimension cm
Colina L	Wandpaneel, Alpina lightgrey 390 siehe Register 1 Seite 5	Panneau mural, Alpina lightgrey 390 voir registre 1 page 5	Wall panel, Alpina lightgrey 390 see index 1 page 5	161, 181, 201, 221
Boa chrom	Leselampe (2er Set) 12V DC, 12 LED kalt weiss	Lampe de lecture (set de 2) 12V DC, 12 LED blanc froid	Reading lamp (set of 2) 12V DC, 12 LED cold white	
Caja	Nachttisch	Table de nuit	Bedside table	48/41/16

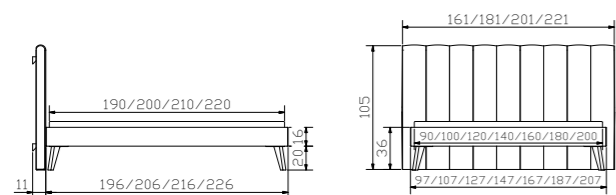

Alle Holzteile in Eiche brandy, geölt
Toutes les parties en chêne brandy, huilé
All wooden parts in oak brandy, oiled

Leselampen und weitere Beimöbel siehe Register 2
Lampes de lecture et autres accessoires voir registre 2
Reading lamps and further accessories see index 2

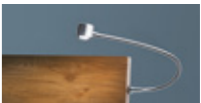
				Dimension cm
Premium 18	Rahmen Breiten Längen	Cadre Largeurs Longueurs	Frame Widths Lengths	90, 100, 120, 140, 160, 180, 200 200, 210, 220
Masi	Füsse Höhen	Pieds Hauteurs	Feet Heights	20, 25
Malta	Kopfteil, Buffalo grey 721 siehe Register 1	Tête de lit, Buffalo grey 721 voir registre 1	Headboard, Buffalo grey 721 see index 1	120, 140, 160, 180, 200
Caja	Nachttisch	Table de nuit	Bedside table	48/41/16
Tina chrom	Leselampe (2er Set) 12 V DC, 1 LED	Lampe de lecture (set de 2) 12 V DC, 1 LED	Reading lamp (set of 2) 12 V DC, 1 LED	

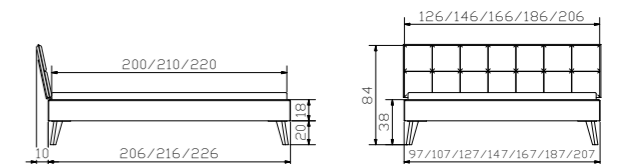



				Dimension cm
Twia	Nachttisch	Table de nuit	Bedside table	45/49/40

				Dimension cm
Premium 18	Rahmen Breiten Längen	Cadre Largeurs Longueurs	Frame Widths Lengths	90, 100, 12140, 160, 180, 200 200, (220)
Tondo anthracit	Füße Höhe	Pieds Hauteur	Feet Height	20
Ceneri	Kopfteil, Casual carbon 334 hat Einfluss auf Bettlänge siehe Register 1 Seite 4	Tête de lit, Casual carbon 334 a un impact sur la longueur du lit voir registre 1 page 4	Headboard, Casual carbon 334 affects the length of bed see index 1 page 4	140, 160, 180, 200

Alle Holzteile in Kernbuche natur, geölt oder anthracit | Toutes les parties en bois en hêtre coeur rouge naturel, huilé ou anthracite | All wooden parts in heart beech natural, oiled or anthracite

Weitere Beimöbel siehe Register 2 | Autres accessoires voir registre 2 | Further accessories see index 2

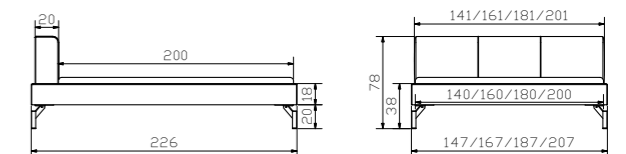



Details siehe Seite 6.9
 Détails voir page 6.9
 Details see page 6.9



Dimension cm

Lovara	Kommode	Commode	Chest of drawers	90/40/75
Treva	Nachttisch	Table de nuit	Bedside table	48/40/51

Dimension cm

Premium 18	Rahmen	Cadre	Frame	140, 160, 180, 200 200, 210, 220
	Breiten Längen	Largeurs Longueurs	Widths Lengths	
Practico-Box	Breiten Längen Höhe	Largeurs Longueurs Hauteur	Widths Lengths Height	140, 160, 180, 200 200, 210, 220 25
	Details siehe Seite 6.9			détails voir page 6.9
	Details siehe Seite 6.9			details see page 6.9
Varus Ravo	Kopfteil Kissen, Campos blanc 372	Tête de lit coussin, Campos blanc 372	Headboard cushion, Campos blanc 372	140, 160, 180, 200 140, 160, 180, 200

Alle Holzteile in Kernbuche natur, geölt | Toutes les parties en bois en hêtre coeur rouge naturel, huilé | All wooden parts in heart beech natural, oiled
Weitere Beimöbel siehe Register 2 | Autres accessoires voir registre 2 | Further accessories see index 2

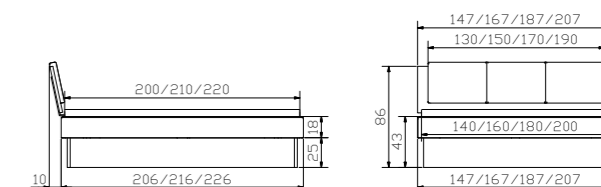



				Dimension cm
Lovara	Kommode	Commode	Chest of drawers	90/40/75
Caja	Nachttisch	Table de nuit	Bedside table	48/41/16

				Dimension cm
Premium 18	Rahmen Breiten Längen	Cadre Largeurs Longueurs	Frame Widths Lengths	90, 100, 120, 140, 160, 180, 200 200, 210, 220
Juve	Füsse Höhen	Pieds Hauteurs	Feet Heights	20, 25
Vola	Kopfteil	Tête de lit	Headboard	90/100, 120, 140, 160, 180, 200

Alle Holzteile in Buche weiss, lasiert, lackiert | Toutes les parties en bois en hêtre teinté blanc lasuré, laqué | All wooden parts in beech white stained, lacquered
Weitere Beimöbel siehe Register 2 | Autres accessoires voir registre 2 | Further accessories see index 2

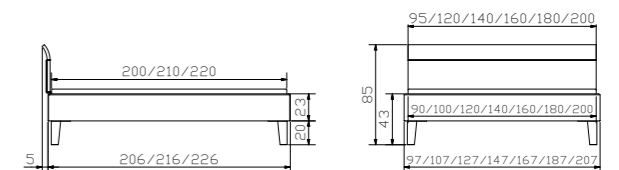



				Dimension cm
Dupla	Nachttisch	Table de nuit	Bedside table	48/40/35

				Dimension cm
Premium 18	Rahmen Breiten Längen	Cadre Largeurs Longueurs	Frame Widths Lengths	90, 100, 120, 140, 160, 180, 200 200, 210, 220
Cielo white	Baldachin Breiten Längen Höhe	Baldaqin Largeurs Longueurs Hauteur	Canopy Widths Lengths Height	120, 140, 160, 180, 200 200/210/220 20
Duetto	Kopfteil	Tête de lit	Headboard	90/100, 120, 140, 160, 180, 200



Curty

Alle Holzteile in Buche weiss lasiert, lackiert
 Toutes les parties en bois en hêtre teinté blanc lasuré, laqué
 All wooden parts in beech white stained, lacquered

Weitere Beimöbel siehe Register 2
 Autres accessoires voir registre 2
 Further accessories see index 2

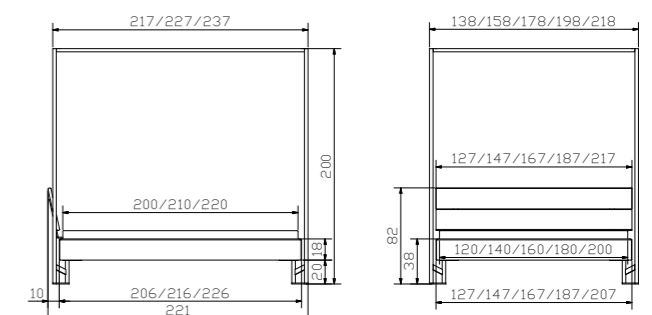
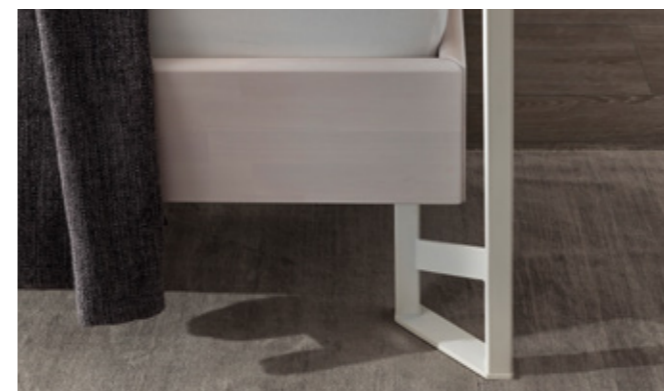



				Dimension cm
Dupla	Nachttisch	Table de nuit	Bedside table	48/40/35

				Dimension cm
Premium 18	Rahmen Breiten Längen	Cadre Largeurs Longueurs	Frame Widths Lengths	90, 100, 120, 140, 160, 180, 200 200, 210, 220
Cantu	Füße Höhen	Pieds Hauteurs	Feet Heights	20, 25, 30
Ripo	Kopfteil, Rinovo taupe 701 siehe Register 1	Tête de lit, Rinovo taupe 701 voir registre 1	Headboard, Rinovo taupe 701 see index 1	90, 100, 120, 140, 160, 180, 200

Alle Holzteile in Buche schoko, lackiert | Toutes les parties en bois en hêtre teinté chocolat, laqué | All wooden parts in beech chocolate, lacquered
Weitere Beimöbel siehe Register 2 | Autres accessoires voir registre 2 | Further accessories see index 2

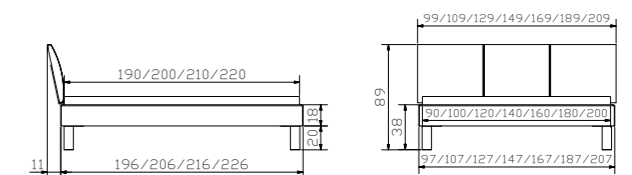



				Dimension cm
Styly	Nachttisch	Table de nuit	Bedside table	43/43/48
Sola	Bank	Secrétaire	Bureau	140/37/38

				Dimension cm
Premium 23	Rahmen Breiten Längen	Cadre Largeurs Longueurs	Frame Widths Lengths	140, 160, 180, 200 200, 210, 220
Lana	Füße Höhen	Pieds Hauteurs	Feet Heights	20, 25
Lara	Kopfteil	Tête de lit	Headboard	140, 160, 180, 200

Alle Holzteile in Eiche bright, geölt | Toutes les parties en bois en chêne bright, huilé | All wooden parts in oak bright, oiled
Lampen und weitere Beimöbel siehe Register 2 | Lampes et autres accessoires voir registre 2 | Lamps and further accessories see index 2

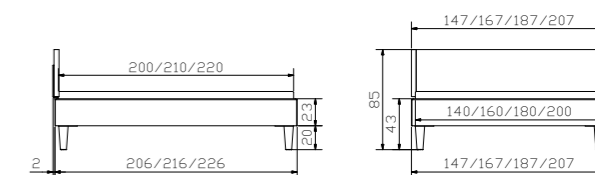



				Dimension cm
Aska	Sekretär	Secrétaire	Bureau	120/60/85
Claudio alu	Herrendiener	Valet	Dressboy	45/28/107
Treva	Nachttisch	Table de nuit	Bedside table	48/40/51

				Dimension cm
Premium 23	Rahmen Breiten Längen	Cadre Largeurs Longueurs	Frame Widths Lengths	120, 140, 160, 180, 200 200, 210, 220
Masi	Füße Höhen	Pieds Hauteurs	Feet Heights	20, 25
Cussina	Kopfteil, Ranch stone 660 siehe Register 1	Tête de lit, Ranch stone 660 voir registre 1	Headboard, Ranch stone 660 see index 1	140, 160, 180, 200

Alle Holzteile in Kernbuche natur, geölt | Toutes les parties en bois en hêtre coeur rouge naturel, huilé | All wooden parts in heart beech natural, oiled
Weitere Beimöbel siehe Register 2 | Autres accessoires voir registre 2 | Further accessories see index 2

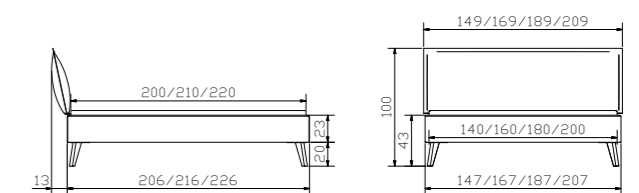



	Dimension cm			
Lovie-Box	1 Bettkasten Breiten	1 Tiroir de lit Largeurs	1 Bed drawer Widths	90, 100, 120, 140
	2 Bettkästen Breiten	2 Tiroirs de lit Largeurs	2 Bed drawers Widths	140, 160, 180, 200
	Höhe	Hauteur	Height	25

	Dimension cm			
Premium 23	Rahmen Breiten Längen	Cadre Largeurs Longueurs	Frame Widths Lengths	140, 160, 180, 200 200, 210, 220
Slid white	Kufen Breiten Höhen	Patins Largeurs Hauteurs	Vats Widths Heights	140, 160, 180, 200 20, 25
Obag	Kopfteil, Campos blanc 372 siehe Register 1	Tête de lit, Campos blanc 372 voir registre 1	Headboard, Campos blanc 372 see index 1	140, 160, 180, 200
Aska	Sekretär	Secrétaire	Bureau	120/60/85
Dowe	Nachttisch	Table de nuit	Bedside table	45/49/55

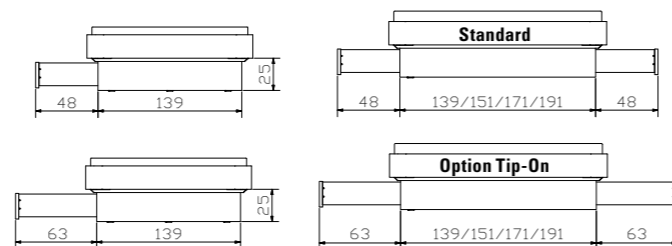

Alle Holzteile in Buche weiss lasiert, lackiert oder Buche weiss, deckend
 Toutes les parties en hêtre teinté blanc lasuré, laqué ou hêtre blanc, couvrant
 All wooden parts in beech white stained, lacquered or beech white covered

Weitere Beimöbel siehe Register 2
 Autres accessoires voir registre 2
 Further accessories see index 2

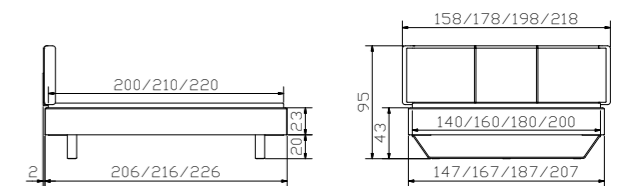



				Dimension cm
Totri	Kommode	Commode	Chest of drawers	135/49/85
Topa anthracit	Bank, inkl. Kissen	Banquette, coussin incl.	Bench, cushion incl.	144/44/38
Banc	Kissen, Kitana aqua 603	Coussin, Kitana aqua 603	Cushion, Kitana aqua 603	119/34/6
Dowe	Nachttisch	Table de nuit	Bedside table	45/49/55
Snake anthracit	Leselampen (2er Set) 12V DC, 6 LED 3 Beleuchtungsarten	Lampe de lecture (set de 2) 12V DC, 6 LED 3 différent illuminations	Reading lamps (set of 2) 12V DC, 6 LED 3 different illuminations	

				Dimension cm
Premium 23	Rahmen Breiten Längen	Cadre Largeurs Longueurs	Frame Widths Lengths	140, 160, 180, 200 200, 210, 220
Juve	Füße Höhen	Pieds Hauteurs	Feet Heights	20, 25
Sogno L	Wandpaneel, Kitana aqua 603 siehe Register 1	Panneau mural, Kitana aqua 603 voir registre 1	Wall panel, Kitana aqua 603 see index 1	161, 181, 201, 221

Alle Holzteile in Buche schoko, lackiert oder anthracit | Toutes les parties en hêtre teinté chocolat, laqué ou anthracite |
All wooden parts in beech chocolate, lacquered or anthracite

Leselampen und weitere Beimöbel siehe Register 2 | Lampes de lecture et autres accessoires voir registre 2 | Reading lamps and further accessories see index 2

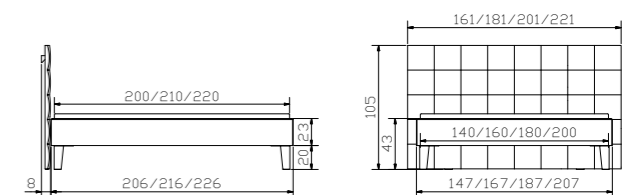

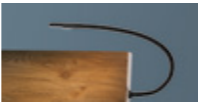

				Dimension cm
Lovara	Kommode	Commode	Chest of drawers	90/40/75
Treva	Nachttisch	Table de nuit	Bedside table	48/40/51
Boa chrom	Leselampe (2er Set) 12V DC, 12 LED warm	Lampe de lecture (set de 2) 12V DC, 12 LED warm	Reading lamp (set of 2) 12V DC, 12 LED warm	

				Dimension cm
Premium 23	Rahmen Breiten Längen	Cadre Largeurs Longueurs	Frame Widths Lengths	140, 160, 180, 200 200, 210, 220
Cantu	Füße Höhen	Pieds Hauteurs	Feet Heights	20, 25, 30
Talma	Kopfteil, Cyclo creme 730 siehe Register 1	Tête de lit, Cyclo creme 730 voir registre 1	Headboard, Cyclo creme 730 see index 1	140, 160, 180, 200

Alle Holzteile in Eiche bright, geölt | Toutes les parties en bois en chêne bright, huilé | All wooden parts in oak bright, oiled
Leselampen und weitere Beimöbel siehe Register 2 | Lampes de lecture et autres accessoires voir registre 2 | Reading lamps and further accessories see index 2

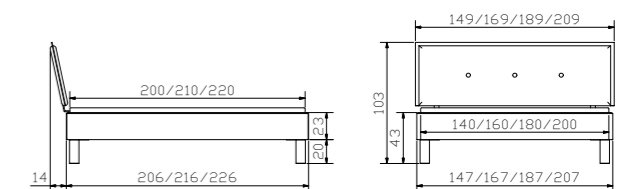



				Dimension cm
Varus	Kopfteil	Tête de lit	Headboard	140, 160, 180, 200
Varo	Kissen (2er Set), Boston tizo 654	Coussins (set de 2), Boston tizo 654	Cushions (set of 2), Boston tizo 654	55/10/35
Duetto	Kopfteil	Tête de lit	Headboard	90/100, 120, 140, 160, 180, 200
Lumo	Kissen, Boston tizo 654	Coussin, Boston tizo 654	Cushion, Boston tizo 654	90/100, 120, 140, 160, 180/200

				Dimension cm
Premium 23	Rahmen	Cadre	Frame	140, 160, 180, 200
	Breiten	Largeurs	Widths	200, 210, 220
	Längen	Longueurs	Lengths	
Slid anthracit	Kufen	Patins	Vats	140, 160, 180, 200
	Breiten	Largeurs	Widths	20, 25
	Höhen	Hauteurs	Heights	
Varus	Kopfteil	Tête de lit	Headboard	140, 160, 180, 200
Ravo	Kissen, Boston tizo 654	Coussin, Boston tizo 654	Cushion, Boston tizo 654	140, 160, 180, 200
Lovara	Kommode	Commode	Chest of drawers	90/40/75
Dupla	Nachttisch	Table de nuit	Bedside table	48/40/35

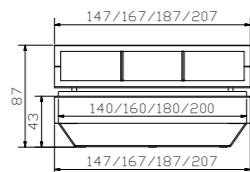
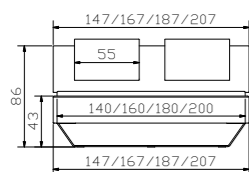

Alle Holzteile in Eiche brandy, geölt
 Toutes les parties en chêne brandy, huilé
 All wooden parts in oak brandy, oiled

Weitere Beimöbel siehe Register 2
 Autres accessoires voir registre 2
 Further accessories see index 2

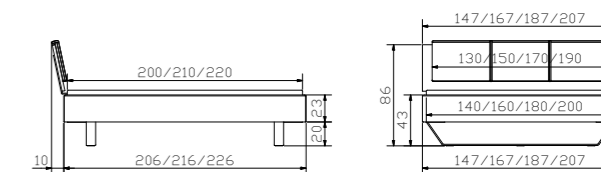

Spazio

Komfortbett mit Stauraum

Lit confortable avec espace de rangement | Comfort bed with storage space

Details und weitere Ausführungen siehe Register 13, Seite 13.10–13.17

Détails et autres versions voir registre 13, page 13.10–13.17

Details and further versions see index 13, page 13.10–13.17



