



swiss bed concept



FACTORY LINE

AKAZIE & EICHE MASSIV | ACACIA & CHENE MASSIF | ACACIA & OAK SOLID

Achten Sie auf FSC®-zertifizierte Produkte | Soyez attentifs aux produits certifiés FSC® | Look for FSC®-certified products

Bettrahmen | Cadre de lit | Bedframe

Bloc 16



Breiten | Largeurs | Widths:
140, 160, 180, 200 cm

Längen | Longueurs | Lengths:
200, 210, 220 cm

Einlegetiefe | Hauteur encastrable | Insertion depth:
16 cm

Loft 18



Breiten | Largeurs | Widths:
90, 100, 120, 140, 160, 180, 200 cm

Längen | Longueurs | Lengths:
200, 210, 220 cm

Einlegetiefe | Hauteur encastrable | Insertion depth:
18 cm

Cone 23



Breiten | Largeurs | Widths:
140, 160, 180, 200 cm

Längen | Longueurs | Lengths:
200, 210, 220 cm

Einlegetiefe | Hauteur encastrable | Insertion depth:
18*, 23 cm

Option

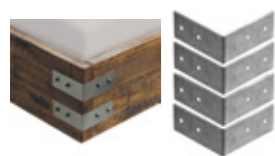

Case 8

Winkel (8er Set zu Loft und Cone Bettrahmen)
Équerres (set de 8 pour cadre de lit Loft et Cone)
Bracket (set of 8 for Loft and Cone bedframe)

Holz | Bois | Wood

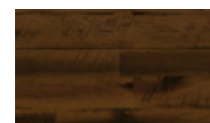

62 Akazie Vintage brown, lackiert
Acacia Vintage brown, laqué
Acacia Vintage brown, lacquered

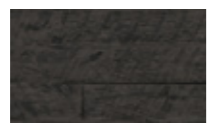

64 Akazie Vintage grey, lackiert
Acacia Vintage grey, laqué
Acacia Vintage grey, lacquered

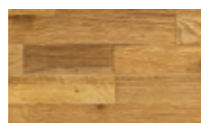

70 Eiche uniq clear, geölt
Chêne uniq clear, huilé
Oak uniq clear, oiled

Hergestellt aus recyceltem Holz
Fabriqué en bois recyclé
Made of recycled wood



No time to waste – Nachhaltigkeit bei Hasena

Le développement durable chez Hasena
Sustainability at Hasena



Unter Pre-Consumer-Recycling versteht man die Rückgewinnung von Abfallstoffen, die bei der Herstellung oder Lieferung von Waren vor der Auslieferung an den Verbraucher anfallen. Recycelte Materialien können zerlegt und in ähnliche oder andere Materialien umgewandelt werden. Denken Sie an die Schnittverluste bei der Herstellung oder an die Holzabfälle, die bei der Möbelproduktion anfallen.

Le recyclage pré-consommation désigne la récupération des déchets générés lors de la production ou de la livraison de marchandises avant leur livraison au consommateur. Les matériaux recyclés peuvent être démontés et transformés en matériaux similaires ou différents. Pensez aux pertes de coupe lors de la fabrication ou aux déchets de bois générés par la production de meubles.

Pre-consumer recycling is the recovery of waste materials generated during the manufacture or supply of goods before delivery to the consumer. Recycled materials can be broken down and transformed into similar or other materials. Think of the cutting losses during manufacturing or the wood waste generated during furniture production.

Mehr über Nachhaltigkeit auf S. 4-7

Pour en savoir plus sur la durabilité, voir p. 4-7
More about sustainability on p. 4-7

Traversen | Traverses | Bars

Wir empfehlen grundsätzlich den Einsatz von Crosstraver (Quertraverse) oder Midtraver (Längstraverse).
Nous recommandons en général l'utilisation de Crosstraver (traverse transversale) ou Midtraver (traverse centrale).
We recommend basically the insertion of Crosstraver (central cross bar) or Midtraver (central bar).

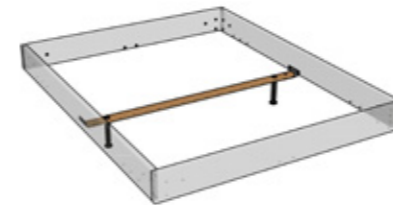

Crosstraver

Quertraverse | Traverse transversale | Central cross bar

Für alle Bettbreiten | Pour toutes les largeurs de lit | For all bed widths

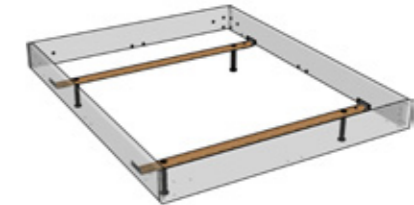

Crosstraver-Twin

Quertraversen | Traverses transversales | Cross bars

Für alle Bettbreiten | Pour toutes les largeurs de lit | For all bed widths

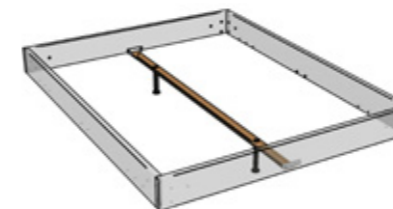

Midtraver

Längstraverse | Traverse centrale | Central bar

Für Betten ab Breite 140 cm mit 2 Lattenrosten oder Motorrahmen-einbau | Pour les lits à partir de 140 cm de largeur avec 2 sommiers ou l'installation d'un cadre motorisé | For beds from 140 cm width with 2 slats or motor frame installation

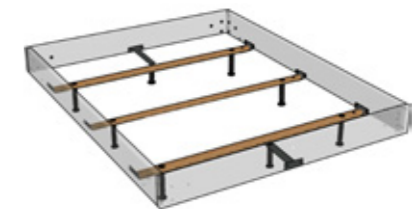

Crosstraver-XXL

Quertraversen | Traverses transversales | Cross bars

Für alle Bettbreiten | Pour toutes les largeurs de lit | For all bed widths

Übersicht Kompatibilität Traversen siehe Seite 2.12 | Aperçu compatibilité traverses voir page 2.12 | Overview compatibility bars see page 2.12

* Cone 23

Bei der Einlegetiefe 18 cm sind die Füße/Sockel um 5 cm versenkt und um diese Höhe weniger sichtbar.

Avec les équerres en position haute (18 cm) les pieds/socle sont encastrés de 5 cm sous le cadre et donc moins visibles.

With the insertion depth 18 cm the feet/socket are sunken in by 5 cm and this height less visible.

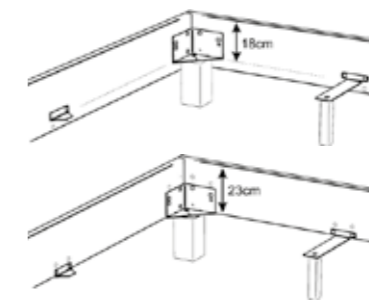

Option Midtraver-move

Achtung: nicht bei Füßen in der Höhe 30 cm, Lovie-Box und Practico-Box einsetzbar

Attention : ne s'applique pas aux pieds avec une hauteur de 30 cm, Lovie-Box et Practico-Box

Attention: not applicable for feet at a height of 30 cm, Lovie-Box and Practico-Box

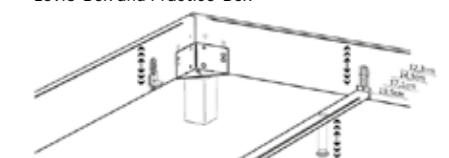

Urbanes Flair

Robust, schroff, mit dekorativen Metallbeschlägen und natürlichen Unregelmäßigkeiten: der unkonventionelle Fabrikhallen-Stil unserer Factory-Line taucht jedes Schlafzimmer in ein aussergewöhnlich urbanes Flair.

Alle Holzteile werden aus massiver Akazie oder Eiche gefertigt. Sie besitzt eine hohe Widerstandsfähigkeit und ist dadurch ein sehr dauerhaftes Holz. Neben dieser Robustheit verfügen Akazie oder Eiche über eine unvergleichliche Elastizität; Rissbildungen und Verziehen des Holzes kommen sehr selten vor. Bitte beachten Sie, dass Farb- und Strukturunterschieden bei Echtholz naturbedingte Eigenschaften sind.

Ambiance urbaine

Robuste, rugueux, avec des ferrures décoratives en métal et des irrégularités naturelles: le style non conventionnel du hall d'usine de notre Factory-Line plonge chaque chambre dans une ambiance urbaine extraordinaire.

Toutes les pièces en bois sont en acacia ou chêne massif. Il a une haute résistance et est donc un bois très durable. En plus de cette robustesse, l'acacia et le chêne possèdent une élasticité incomparable; les fissures et les déformations du bois sont très rares. Veuillez noter que les différences de coloris et de structures sont des caractéristiques naturelles du bois.

Urban flair

Robust, rugged, with decorative metal fittings and natural irregularities: the unconventional factory hall style of our Factory-Line immerses every bedroom in an extraordinary urban flair.

All wooden parts are made of solid acacia or oak. It has a high resistance and is therefore a very durable wood. In addition to this robustness, acacia and oak have an incomparable elasticity; cracking and warping of the wood occur very rarely. Please note that differences in colour and texture are natural features of real wood.

Füsse | Pieds | Feet



Holz | Bois | Wood



Standard: gedämpfter Selbsteinzug Blumotion von BLUM
Option: Tip-On-Öffnung mit Vollauszug von BLUM
Standard: système d'amortissement Blumotion de BLUM
Option: ouverture Tip-On avec sortie totale de BLUM
Standard: soft closing runner Blumotion of BLUM
Option: opening Tip-On with full extension of BLUM

Holz | Bois | Wood

	Masse cm Dimensions cm	Breiten cm Largeurs cm Widths cm	Höhen cm Hauteurs cm Heights cm				Holzfarben Couleurs bois Colours wood				
			10	20	25	30	10	16	62	64	70
Evio		90-200									
Gola	8/5x8/5										
Ivio	10x10										
Lovie-Box* (1 Schublade/Tiroir/Drawer)		90-140									
Lovie-Box* (2 Schubladen/Tiroirs/Drawers)		140-200									
Practico-Box (inkl. Boden Fond inclus Bottom included)		90-200									
Stabil**		140-200									
Vilo		90-200									

*bei Cone 23 Rahmen nur mit Einlegetiefe 23 cm möglich | avec cadre Cone 23 uniquement possible avec la hauteur encastrable de 23 cm | with Cone 23 frame only possible with insertion depth 23 cm

**Stabil nur mit Bloc 16 Rahmen möglich | Stabil uniquement possible avec cadre de lit Bloc16 | Stabil only possible with frame Bloc 16

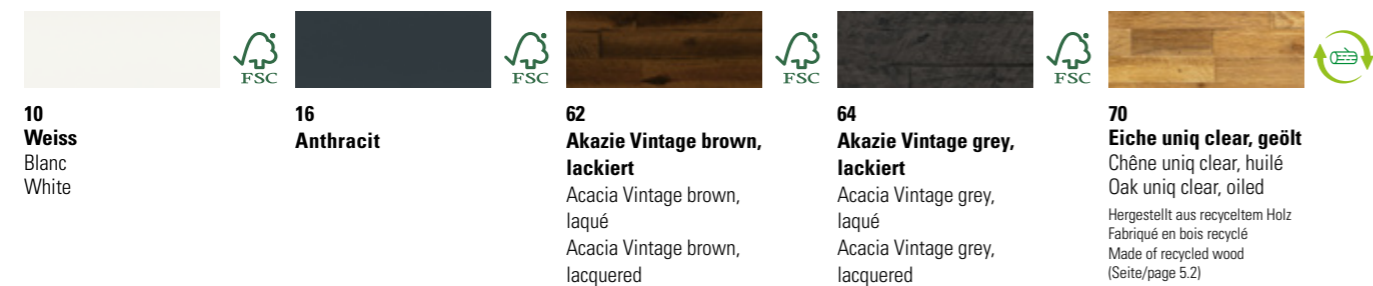

Füsse | Pieds | Feet

Metall | Métal | Metal



Metall Métal Metal	Masse cm Dimensions cm	Breiten cm Largeurs cm Widths cm	Höhen cm Hauteurs cm Heights cm				Metallfarben Couleurs métal Colours metal										
			10	20	25	30	00	04	10	16	40	41	42	43	45		
Caro	6x6																
Cielo***		120-200															
Facil																	
Fasio	Ø5/9																
Indus	6x2	140-200															
Jeno	12x5																
Mico	8x8																
Quada	20x6,5																
Reca	24x12																
Road*	Ø13																
Slid	8/1	140-200															
Soko	Ø6																
Stomp	Ø8																
Tondo	Ø3,5																

*Füsse fixiert, Rollen nur optisch | Pieds fixes, roulettes uniquement décoratives | Feet fixed, castors only visual

▲ Curty Vorhang und Vela Baldachin-Tuch siehe Register 2, Seite 12 | Curty rideau et Vela tissu de baldaquin voir registre 2, page 12 | Curty curtain and Vela canopy cloth see index 2, page 12



00 Chrom = Edelstahl poliert | Acier polît | Stainless steel polished
 04 Used = Stahl galvanisiert | Acier galvanisé | Steel galvanised
 10 White = Stahl pulverbeschichtet | Acier thermolaqué | Steel powder-coated
 16 Anthracit = Stahl pulverbeschichtet | Acier thermolaqué | Steel powder-coated
 40 Bronze = Stahl lackiert | Acier laqué | Steel lacquered

41 Copper = Stahl lackiert | Acier laqué | Steel lacquered
 42 Alu = Stahl pulverbeschichtet | Acier thermolaqué | Steel powder-coated
 43 Inox = Edelstahl geschliffen | Acier inoxydable poncé | Stainless steel ground
 45 Iron = Metall geflammt, pulverbeschichtet | Métal flammé, thermolaqué | Metal mottled, powder-coated

Bettkasten mit Holzkufen | Tiroirs de lit avec patins en bois | Bed drawers with wooden vat



Lovie-Box + Covero  **90-140 cm 1 Schublade** | 1 Tiroir | 1 Drawer

Stauraum | Compartment de rangement | Storage space:
134×61×16 cm

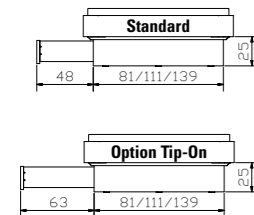

Standard: gedämpfter Selbstzug Blumotion von BLUM
Option: Tip-On-Öffnung mit Vollauszug von BLUM

Lovie-Box + Saceto  **140-200 cm 2 Schubladen** | 2 Tiroirs | 2 Drawers

Stauraum | Compartment de rangement | Storage space:
2×134×61×16 cm

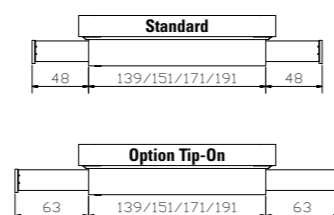

Standard: système d'amortissement Blumotion de BLUM
Option: ouverture Tip-On avec sortie totale de BLUM
Standard: soft closing runner Blumotion of BLUM
Option: opening Tip-On with full extension of BLUM

Roll-Box 20/25 



Bettkasten in weiss oder anthrazit (Boden weiss)

Voraussetzung
Bettfusshöhe von mindestens 20cm erforderlich

Optionen
Deckel Covero in weiss, Stoffabdeckung Saceto in Polyester grau.

Roll-Box 20/25 + Covero 



Tiroir de lit en blanc ou anthracite (fond blanc)

Condition préalable
Une hauteur de pieds de lit d'au moins 20 cm est nécessaire

Options
Couvercle Covero en blanc, tissu de protection Saceto en polyester gris.

Roll-Box 20/25 + Saceto 



Bed drawer in white or anthracite (bottom white)

Condition
Feet of bed need a minimum height of 20 cm

Options
Cover Covero in white, tissue of protection Saceto in polyester grey.

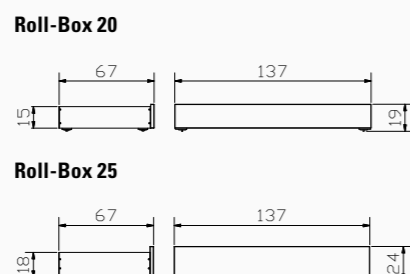

Stauraum Espace de rangement Storage space		
Roll-Box 20	=	134×61×13 cm
Roll-Box 25	=	134×61×16 cm

Bettkasten | Coffres à literie | Bedding boxes

Practico-Box + Loft 18 + Ultrafree-Lift KF



Ultrafree-Lift KF



Box = inkl. Boden, Anwendung siehe Seite 5.17
zu Practico-Box:
Lattenrost **Ultrafree-Lift KF**
Kopf-/Fussverstellung
Rahmenholme Höhe 7 cm und 28 Federleisten aus Buchenschichtholz
Gesamthöhe 11 cm

Lattenrost **Econom-move**
Unverstellbar
Rahmenholme Höhe 6 cm und 28 Federleisten aus Buchenschichtholz
Gesamthöhe 9 cm

inkl. Gasdruckfedern und allen Beschlägen

Details zu Ultrafree-Lift KF und Econom-move siehe Register 14, Seite 14.8

Practico-Box + Loft 18 + Econom-move



Econom-move



Box = fond inclus, utilisation voir page 5.17
pour box Practico:
Sommier **Ultrafree-Lift KF**
Tête et pied réglables
Cadre, hauteur 7 cm et 28 lattes en hêtre multiplis
Hauteur totale 11 cm

Sommier **Econom-move**
Non réglable
Cadre, hauteur 6 cm et 28 lattes en hêtre multiplis
Hauteur totale 9 cm

Pistons à gaz et toute la quincaillerie inclus

Détails pour Ultrafree-Lift KF et Econom-move voir registre 14, page 14.8

Stauraum Espace de rangement Storage space		
90 × 200/210/220	=	81 × 190/200/210 × 24 cm
100 × 200/210/220	=	91 × 190/200/210 × 24 cm
120 × 200/210/220	=	111 × 190/200/210 × 24 cm
140 × 200/210/220	=	131 × 190/200/210 × 24 cm
160 × 200/210/220	=	74 × 190/200/210 × 24 (2 x) cm
180 × 200/210/220	=	84 × 190/200/210 × 24 (2 x) cm
200 × 200/210/220	=	94 × 190/200/210 × 24 (2 x) cm

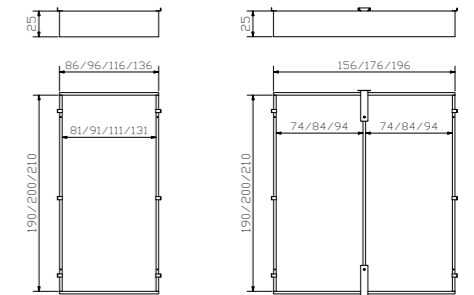

Box = bottom incl., handling see page 5.17
for Practico-box:
Slats **Ultrafree-Lift KF**
Head/footpiece adjustable
Frame, height 7 cm and 28 slats are of beech veneer board
Total height 11 cm

Slats **Econom-move**
Not adjustable
Frame, height 6 cm and 28 slats are of beech veneer board
Total height 9 cm

Pneumatic compression spring and all fittings included

Details for Ultrafree-Lift KF and Econom-move see index 14, page 14.8

Himmelbett ohne Grenzen

Lit à baldachin sans frontières | Canopy bed without borders

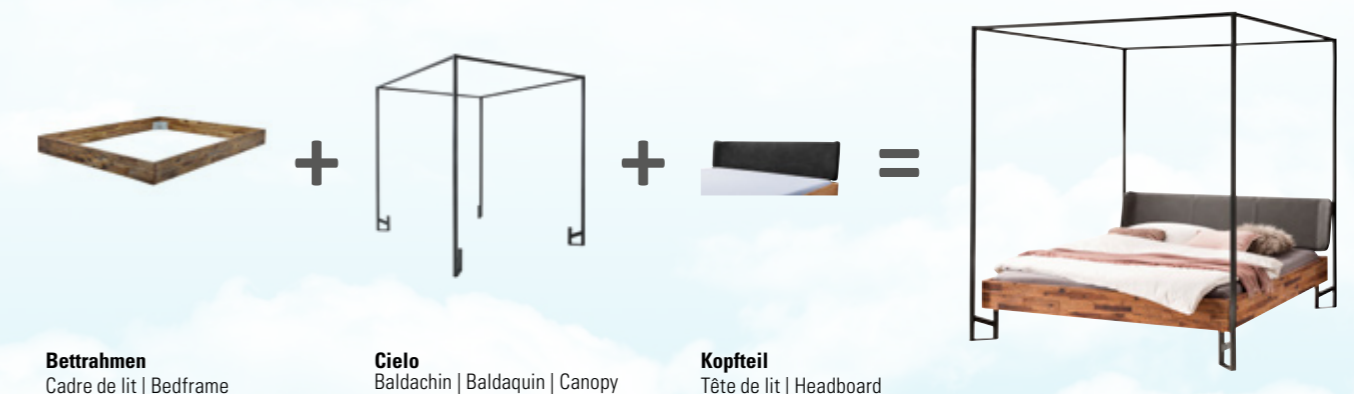

Betrahmen
Cadre de lit | Bedframe

Cielo
Baldachin | Baldachin | Canopy

Kopfteil
Tête de lit | Headboard

Kopfteile | Têtes de lit | Headboards

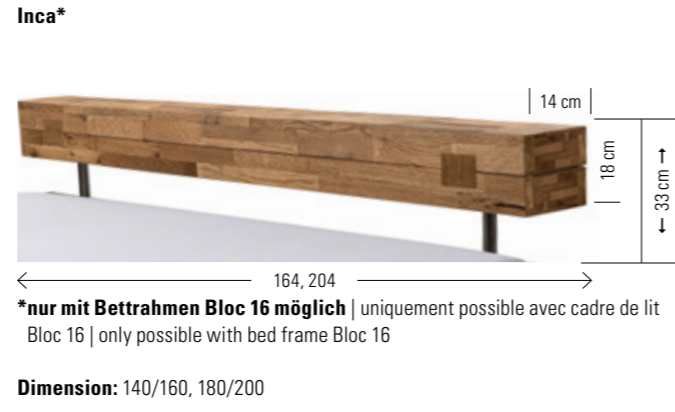

***nur mit Bettrahmen Bloc 16 möglich | uniquement possible avec cadre de lit Bloc 16 | only possible with bed frame Bloc 16**

Gepolsterte Kopfteile, Wandpaneele, Stoffauswahl/Farben siehe Register 1, Leselampen siehe Register 2.
Têtes de lits rembourrées, panneaux muraux, choix de tissus/couleurs voir registre 1, lampes de lecture voir registre 2.
Upholstered headboards, wallpanels, choice of tissues/colours see index 1, reading lamps see index 2.



Ausführungen | Exécutions | Executions

Holz | Bois | Wood

 62 Akazie Vintage brown, lackiert Acacia Vintage brown, laqué Acacia Vintage brown, lacquered	 64 Akazie Vintage grey, lackiert Acacia Vintage grey, laqué Acacia Vintage grey, lacquered	 70 Eiche uniq clear, geölt Chêne uniq clear, huilé Oak uniq clear, oiled Hergestellt aus recyceltem Holz Fabriqué en bois recyclé Made of recycled wood (Seite/page 5.2)
--	---	---

Adapter | Adaptateur | Adapter

Bei hohen Matratzen kann mit dem Verlängerungsadapter das Kopfteil erhöht werden.
La tête de lit peut être rehaussée avec l'adaptateur lorsque le matelas est plus épais.
With the extension adapter the headboard can be extended if mattresses are high.

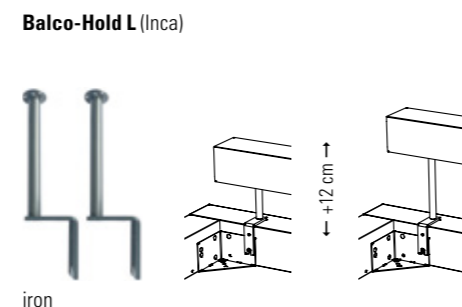
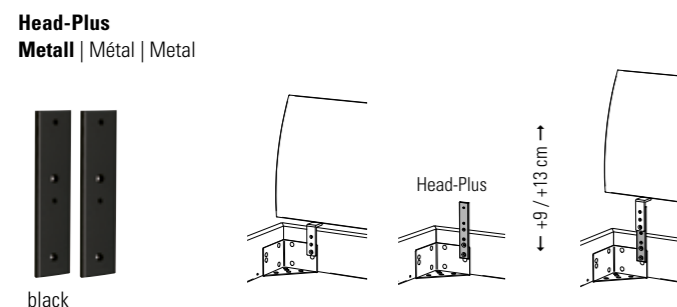

Kissen und Kopfteile gepolstert | Coussins et têtes de lit capitonnées | Cushions and headboards upholstered



Befestigung mit 2 Bändern (Klettverschluss)
Fixation avec 2 bandes (Velcro®)
Fixation with 2 ribbons (Velcro® fastener)

Kissen | Coussins | Cushions

	Effektive Masse cm Dimensions effectives cm Effective dimensions cm
Arona	86, 116, 136, 156, 176×3,5×25
Lumo	86, 116, 136, 156, 176×6×25
Nakio (2er Set Set de 2 Set of 2)	55×18×14
Ravo	80, 110, 130, 150, 170, 190×3,5×35
Sunny (2er Set Set de 2 Set of 2)	55×6×40
Varo (2er Set Set de 2 Set of 2)	55×10×35

zu Kopfteilen pour têtes de lit for headboards

	Arcada	Varus	Inca
Arona	●		
Lumo	●		
Nakio			●
Ravo	●	●	
Sunny	●	●	
Varo	●	●	

Breitenmasse cm Dimensions de largeur cm Widths dimensions cm

Arona	90/100, 120, 140, 160, 180/200
Lumo	90/100, 120, 140, 160, 180/200
Nakio	
Ravo	90/100, 120, 140, 160, 180, 200
Sunny	
Varo	

Alle Kissen in Echtleder haben Zier- sowie Teilungsnähte. Ausnahmen: Nakio, Sunny und Varo, diese Kissen haben lediglich Ziernähte. | Tous les coussins en cuir véritable ont des coutures décoratives et des coutures de séparation. A l'exception des coussins : Nakio, Sunny et Varo, ces coussins ont uniquement des coutures décoratives. | All cushions in genuine leather have decorative and dividing seams. Exceptions: Nakio, Sunny and Varo, these cushions only have decorative seams.



Das Kopfteil Dorma enthält in Echtleder keine Teilungsnähte. | En cuir véritable, la tête de lit Dorma ne comporte pas de coutures de séparation. | The Dorma headboard contains no dividing seams in genuine leather.

***nur mit Bettrahmen Bloc möglich | uniquement possible avec cadre de lit Bloc | only possible with bed frame Bloc**

Nachttische, Kommoden, Bänke + Kissen | Tables de nuit, commodes, banquettes + coussins | Bedside tables, chest of drawers, benches + cushions



Jago

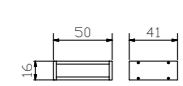

Jesa

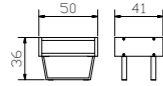

Lica

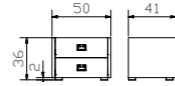

Carpi

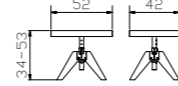

- ◀ **höhenverstellbar**
réglable en hauteur
adjustable in height
- ◀ **inkl. Glasplatte**
plateau en verre inclus
incl. glass plate

Calino

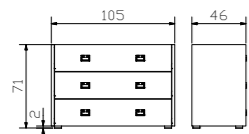

Scola / Case 4

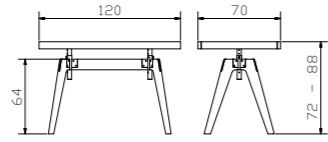

- höhenverstellbar** | réglable en hauteur | adjustable in height
- Schreibtischunterlage** | Sous-main de bureau | Deskpad Casual carbon 334

Case 4



- 4er Set zu** | set de 4 pour | set of 4 for: Calino, Lica, Scola

Coban

anthracit, copper, bronze

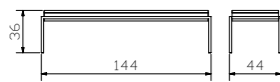

Topia

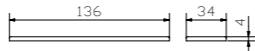

Vano

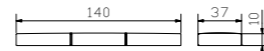

Topa

anthracit, copper, bronze

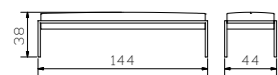

Stoffauswahl siehe Register 1, Seiten 1.6–1.7
Choix de tissus voir registre 1, pages 1.6–1.7
Choice of tissues see index 1, pages 1.6–1.7

Ausführungen | Exécutions | Executions

Holz | Bois | Wood

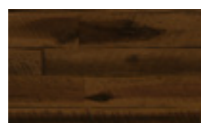

62 Akazie Vintage brown, lackiert
Acacia Vintage brown, laqué
Acacia Vintage brown, lacquered

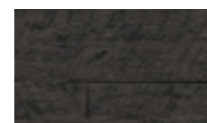

64 Akazie Vintage grey, lackiert
Acacia Vintage grey, laqué
Acacia Vintage grey, lacquered



70 Eiche uniq clear, geölt
Chêne uniq clear, huilé
Oak uniq clear, oiled
Hergestellt aus recyceltem Holz
Fabriqué en bois recyclé
Made of recycled wood
(Seite/page 5.2)



selezione

01

MODELLAUSWAHL

Sélection du modèle | Model selection

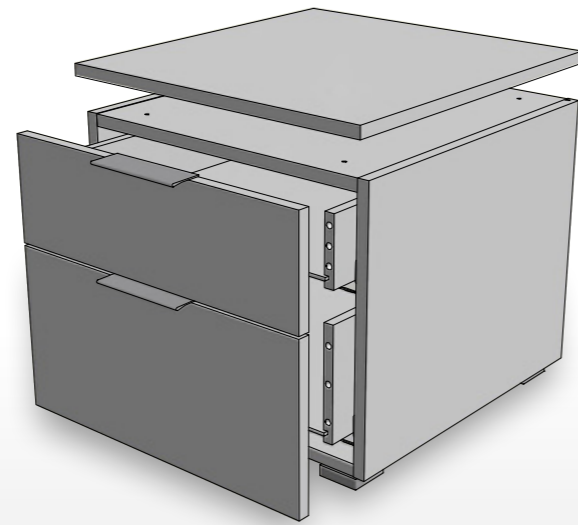

02

KORPUS

Caisson | Body



03

TOP/FRONT

Farben | Couleurs | Colours

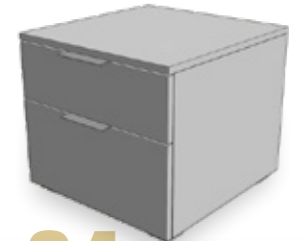

04

GRIFFE

Poignées | Handles

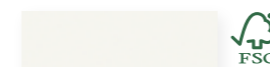
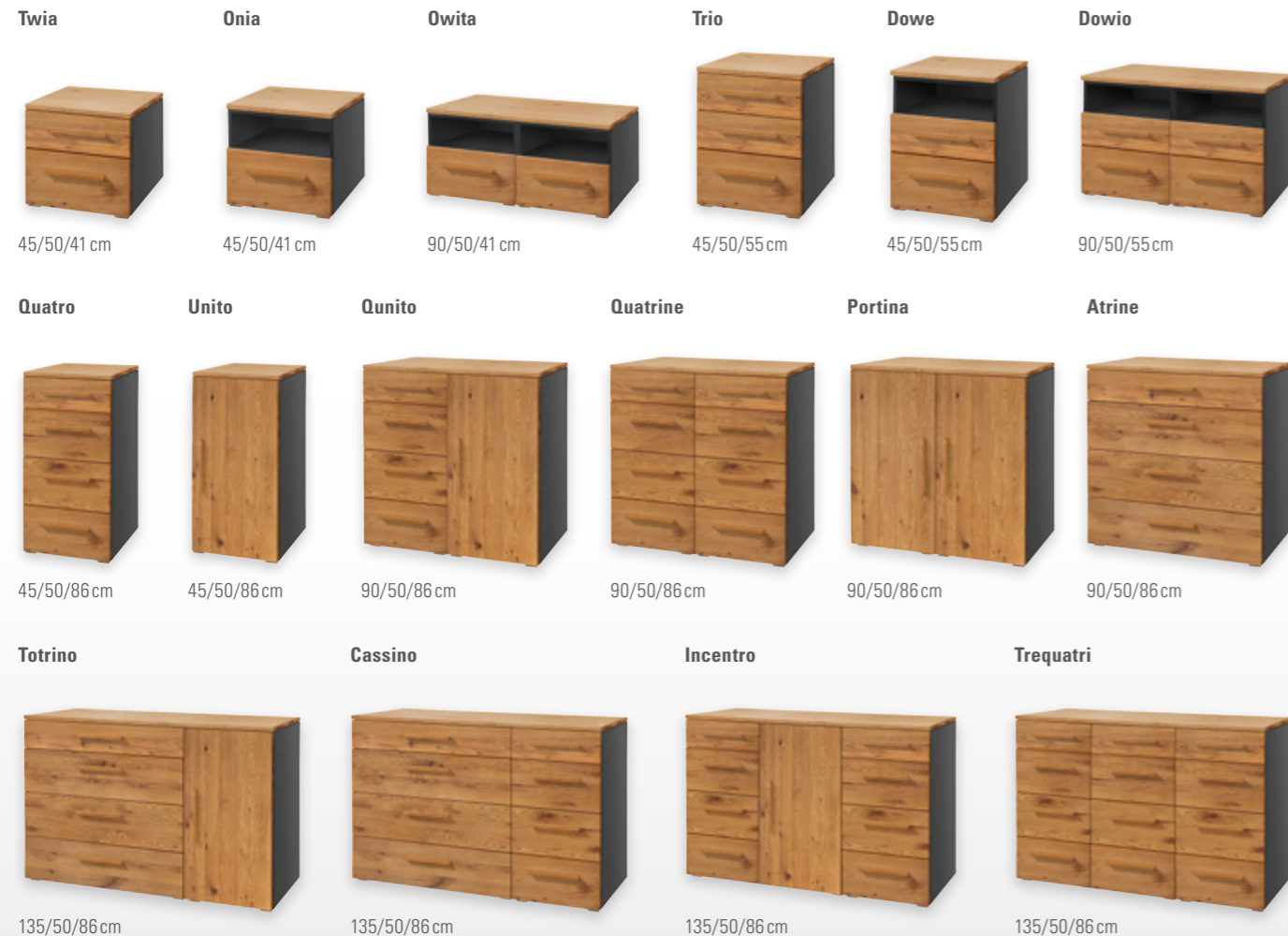

10 Weiss | Blanc | White



16 Anthracit | Anthracite

+ FÜSSE

Pieds | Feet

STANDARD



OPTION

Leg 8 cm



alu

Jone 10 cm



anthracit
used

Cila 10 cm



anthracit

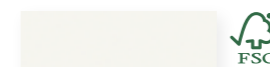

10 Weiss | Blanc | White



16 Anthracit | Anthracite

STANDARD



Alu

Griff zu Folienfronten

Poignée pour façades en mélaminé
Handle for foil fronts



74 Eiche bright, geölt
Chêne bright, huilé
Oak bright, oiled

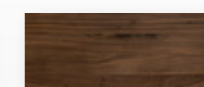

82 Nussbaum, geölt
Noyer, huilé
Walnut, oiled

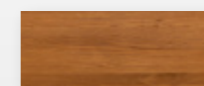

76 Eiche brandy, geölt
Chêne brandy, huilé
Oak brandy, oiled

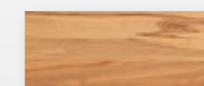

87 Wildbuche natur, geölt
Hêtre naturel, huilé
Wildbeech natural, oiled



80 Kernbuche natur, geölt
Hêtre coeur rouge
naturel, huilé
Heart beech natural, oiled



99 Wildeiche natur, geölt
Chêne naturel, huilé
Wildoak natural, oiled

STANDARD



Holzgriff zu Holzfronten

Poignée en bois pour façades en bois
Wooden handle for wooden fronts

OPTION

Rivo



Used

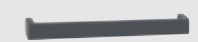

Anthracit

Metallgriff zu Holzfronten

Poignée en métal pour façades en bois
Metal handle for wooden fronts

Stellen Sie sich Ihr Wunsch-Beimöbel nach Ihrem Geschmack zusammen: Der Korpus (Abb. 02), in zwei verschiedenen Farbvarianten, lässt sich zu den Front- und Top-Covern (Abb. 03) in acht Holz- und Farbausführungen kombinieren. Die Beimöbel können zerlegt oder teilmontiert bestellt werden. Bei zusammengesetzten Möbeln (z. B. Qunito, Incentro, ...) muss der Deckel noch montiert werden. Bei Kommoden mit Türen ist jeweils ein Einlegeboden vorhanden, Türöffnung nach links oder rechts möglich. Zusätzliche Böden sind erhältlich.

Composez le meuble d'appoint de vos rêves selon vos goûts : Le caisson (ill. 02), disponible en 2 variantes de couleurs, peut être combiné avec les façades et couvercles supérieurs (ill. 03) en 8 finitions de bois et de coloris. Les meubles d'appoint peuvent être commandés en kits ou assemblés. Pour les meubles assemblés (p. ex. Qunito, Incentro, ...) le couvercle doit encore être fixé. Les commodes avec portes sont équipées d'une étagère, ouverture de la porte possible à gauche ou à droite. Si besoin, des étagères supplémentaires sont disponibles.

Put together the side furniture you want according to your own taste: The body (fig. 02), in two different colour versions, can be combined with the front and top covers (fig. 03) in eight wood and colour versions. The furniture can be ordered disassembled or assembled. For assembled furniture (e.g. Qunito, Incentro, ...) the top cover must still be fitted. Chests of drawers with doors have one shelf, door opening possible to the left or right. Additional shelves are available.



Kombinationsbeispiele
und techn. Informationen
Exemples et informations
Examples and informations



Lattenroste | Sommier | Slats



Dritto U

U = Unverstellbar
Non réglable
Not adjustable

Rahmenholme und 14 Federleisten aus Buchenschichtholz
Cadre et 14 lattes en hêtre multiplis
Frame and 14 slats are of beech veneer board

Starre Lagerung
Suspension rigide
Rigid suspension

Längen | Longueurs | Lengths

200

Höhe | Hauteur | Height: 6 cm

Keine Sondermasse möglich | Dimensions spéciales non disponibles |
No special sizes possible

Breiten | Largeurs | Widths

80	90	100	120	140
●	●	●	●	●



Flexo K

K = Kopfteil manuell 13-fach verstellbar
Réglage manuel de la tête en 13 positions
Head piece manually adjustable in 13 positions

Rahmenholme und 28 Federleisten aus Buchenschichtholz
Cadre et 28 lattes en hêtre multiplis
Frame and 28 slats are of beech veneer board

Flexible Lagerung
Suspension flexible
Flexible suspension

Schulterkomfortzone
Zone de confort des épaules
Comfort zone for shoulders

Mittelzonenverstärkung
Zone médiane renforcée
Reinforcement of the middle zone



Längen | Longueurs | Lengths

200, 210, 220

Höhe | Hauteur | Height: 9 cm

Keine Sondermasse möglich | Dimensions spéciales non disponibles |
No special sizes possible

Breiten | Largeurs | Widths

80	90	100	120	140
●	●	●	●	●



Ultrafree RF

RF = Rücken- und Fussteil manuell je 13-fach verstellbar
Réglage manuel pour le haut du corps et les jambes en 13 positions
Back and foot sections manually adjustable in 13 positions

Rahmenholme und 30 Federleisten aus Buchenschichtholz
Cadre et 30 lattes en hêtre multiplis
Frame and 30 slats are of beech veneer board

Details siehe Seite 13.2-13.3
Détails voir page
Details see page:
13.2-13.3

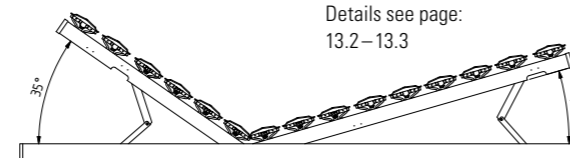

Längen | Longueurs | Lengths

200, 210, 220

Höhe | Hauteur | Height: 10 cm

Keine Sondermasse möglich | Dimensions spéciales non disponibles |
No special sizes possible

Breiten | Largeurs | Widths

80	90	100	120	140
●	●	●	●	●

Matratzen | Matelas | Mattresses

Novo

7-Zonen-Kaltschaumkern, Höhe 8 cm in Härtegrad H3 (RG 35) erhältlich
7-zones noyau en mousse froide, hauteur 8 cm disponible dans le degré de fermeté f3 (densité 35)
7-zones core cold foam, height 8 cm available in the degree of hardness H3 (density 35)

Optimale Unterstützung durch 7-Zonen-Kaltschaum-Noppenprofil in 2.5 cm Stärke
Soutien optimal grâce à une mousse 7-zones froide à picots 2.5 cm
Optimum support through 7-zones cold foam upholstery 2.5 cm with nobs

Breiten | Largeurs | Widths 80, 90, 100, 120, 140, 160, 180, 200 cm

Längen | Longueurs | Lengths 200, 210, 220 cm

Höhe | Hauteur | Height 16 cm

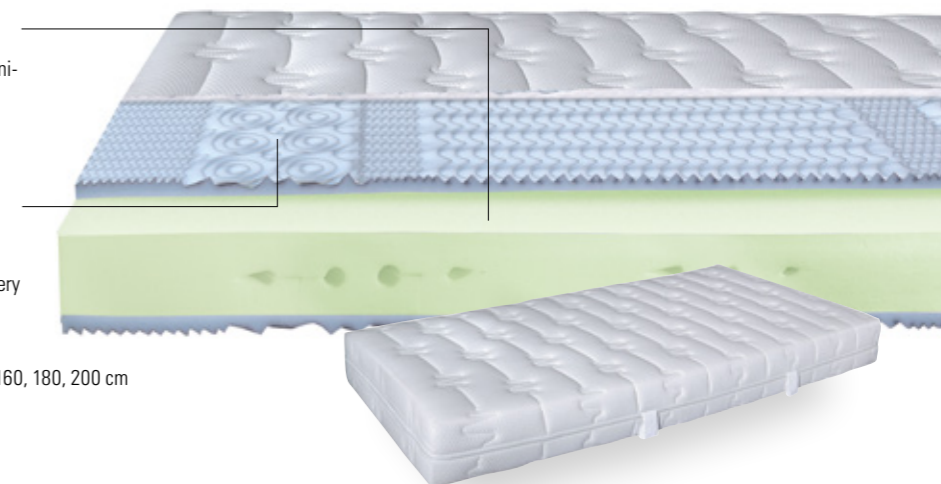

Ultraconfort

7-Zonen-Kaltschaumkern, Höhe 12 cm in den Härtegraden H3 (RG 45) und H4 (RG 50) erhältlich
7-zones noyau en mousse froide, hauteur 12 cm disponible dans les degrés de fermeté f3 (densité 45) et f4 (densité 50)
7-zones core cold foam, height 12 cm available in the degrees of hardness H3 (density 45) and H4 (density 50)

Optimale Unterstützung und Klimatisierung durch 4 cm Soft-Kaltschaum-Auflage RG 60
Soutien optimal et climatisation idéale grâce à une mousse froide souple 4 cm densité 60
Optimum support and climate regulation through 4 cm soft cold foam upholstery density 60

Breiten | Largeurs | Widths 80, 90, 100, 120, 140, 160, 180, 200 cm

Längen | Longueurs | Lengths 200, 210, 220 cm

Höhe | Hauteur | Height 21 cm

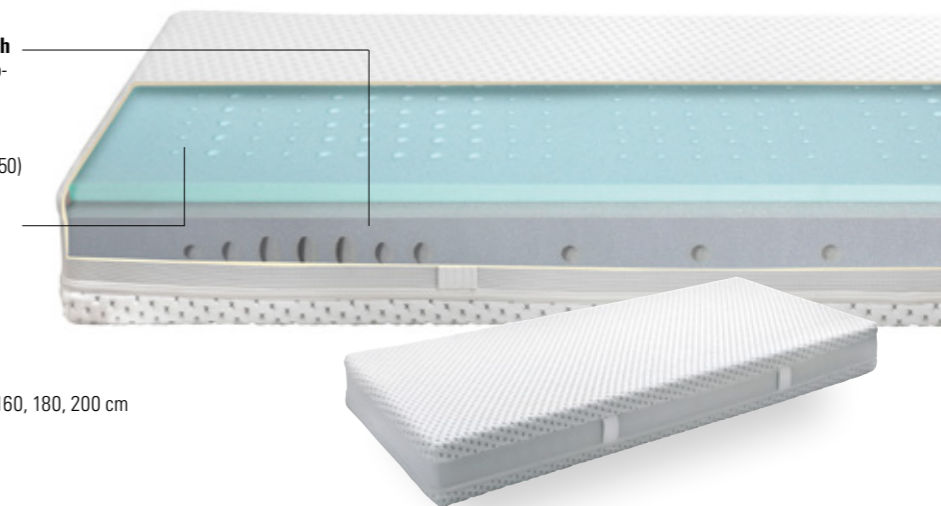

Ultramotion

7-Zonen-Kaltschaum-Tröpfchenkern mit Querbelüftung und Schulterzone, Höhe 20 cm in den Härtegraden H2 (RG 53), H3 (RG 53) und H4 (RG 45) erhältlich

7-zones noyau de gouttelettes en mousse froide avec ventilation transversale et zone pour les épaules, hauteur 20 cm disponible dans les degrés de fermeté f2 (densité 53), f3 (densité 53) et f4 (densité 45)
7-zones cold foam droplet core with lateral ventilation and shoulder zone, height 20 cm available in the degrees of hardness H2 (density 53), H3 (density 53) and H4 (density 45)

Breiten | Largeurs | Widths 80, 90, 100, 120, 140, 160, 180, 200 cm

Längen | Longueurs | Lengths 200, 210, 220 cm

Höhe | Hauteur | Height 23 cm



Informationen zu Matratzenbezügen und weitere Lattenroste und Matratzen siehe Register 13

Informations sur les housses de matelas et autres sommier et matelas, voir registre 13
Information on mattress covers and other slatted frames and mattresses, see tab 13.



				Dimension cm
Scola	Sekretär höhenverstellbar Schreibtischunterlage in Casual carbon 334	Secrétaire réglable en hauteur Sous-main de bureau en Casual carbon 334	Bureau adjustable in height Deskpad in Casual carbon 334	120/70/72-88
Carpi	Nachttisch höhenverstellbar 34–53 cm	Table de nuit réglable en hauteur 34–53 cm	Bedside table adjustable in height 34–53 cm	52/42/34-53

				Dimension cm
Bloc 16	Rahmen Breiten Längen	Cadre Largeurs Longueurs	Frame Widths Lengths	140, 160, 180, 200 200, 210, 220
Slid anthracit	Kufen Breiten Höhen	Patins Largeurs Hauteurs	Vats Widths Heights	140, 160, 180, 200 20, 25
Opera	Kopfteil, Fusio shell 750	Tête de lit, Fusio shell 750	Headboard, Fusio shell 750	140, 160, 180, 200



Alle Holzteile in Akazie Vintage brown, lackiert
 Toutes les parties en bois en acacia Vintage brown, laqué
 All wooden parts in acacia Vintage brown, lacquered
Weitere Beimöbel siehe Register 2
 Autres accessoires voir registre 2
 Further accessories see index 2

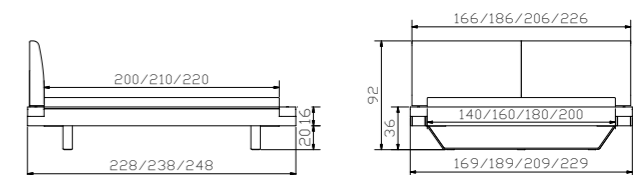



Details siehe Seite 5.7
 Détails voir page 5.7
 Details see page 5.7

				Dimension cm
Atrine	Kommode	Commode	Chest of drawers	90/49/85
Onia	Nachttisch	Table de nuit	Bedside table	45/49/40

				Dimension cm
Bloc 16	Rahmen Breiten Längen	Cadre Largeurs Longueurs	Frame Widths Lengths	140, 160, 180, 200 200, 210, 220
Practico-Box	Anthrazit Breiten Längen Höhe	Anthracite Largeurs Longueurs Hauteur	Anthracite Widths Lengths Height	140, 160, 180, 200 200, 210, 220 25
Ripo	Kopfteil, Casual sahara 330 siehe Register 1	Tête de lit, Casual sahara 330 voir registre 1	Headboard, Casual sahara 330 see index 1	90, 100, 120, 140, 160, 180, 200

Alle Holzteile in Akazie Vintage grey, lackiert oder anthracit | Toutes les parties en bois en acacia Vintage grey, laqué ou anthracite |
 All wooden parts in acacia Vintage grey, lacquered or anthracite

Weitere Beimöbel siehe Register 2 | Autres accessoires voir registre 2 | Further accessories see index 2

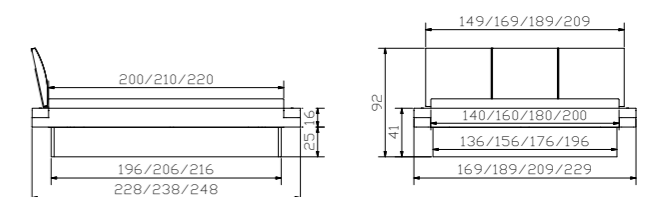



				Dimension cm
Calino	Kommode	Commode	Chest of drawers	105/46/71
Carpi	Nachttisch höhenverstellbar 34–53 cm	Table de nuit réglable en hauteur 34–53 cm	Bedside table adjustable in height 34–53 cm	52/42/34-53

				Dimension cm
Bloc 16	Rahmen Breiten Längen	Cadre Largeurs Longueurs	Frame Widths Lengths	140, 160, 180, 200 200, 210, 220
Stabil	Kufen Breiten Höhe	Patins Largeurs Hauteur	Vats Widths Height	140, 160, 180, 200 25
Inca Nakio	Kopfteil Kissen (2er Set) Casual carbon 334	Tête de lit Coussins (set de 2) Casual carbon 334	Headboard Cushions (set of 2) Casual carbon 334	140/160, 180/200 55/18/14

Alle Holzteile in Akazie Vintage grey, lackiert | Toutes les parties en bois en acacia Vintage grey, laqué | All wooden parts in acacia Vintage grey, lacquered
 Weitere Beimöbel siehe Register 2 | Autres accessoires voir registre 2 | Further accessories see index 2

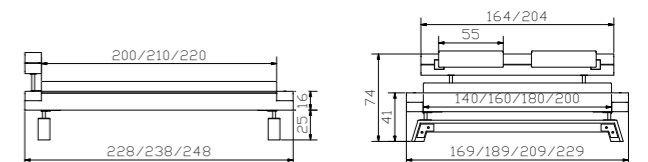



Dimension cm

Bloc 16	Rahmen Breiten Längen	Cadre Largeurs Longueurs	Frame Widths Lengths	Dimension cm
				140, 160, 180, 200 200, 210, 220
Ivio	Füße Höhen	Pieds Hauteurs	Feet Heights	10, 20, 25
Varus	Kopfteil	Tête de lit	Headboard	90/100, 120, 140, 160, 180, 200
Ravo	Kissen Buffalo grey 721	Coussin Buffalo grey 721	Cushion Buffalo grey 721	90/100, 120, 140, 160, 180, 200

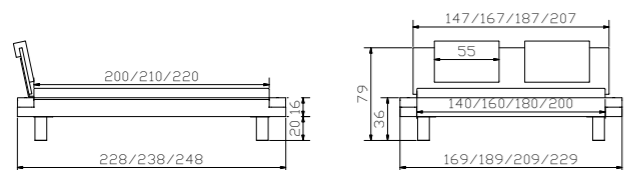

Alle Holzteile in Eiche uniq clear, geölt - Hergestellt aus recycletem Holz
 Toutes les parties en bois en chêne uniq clear, huilé - Fabriqué en bois recyclé
 All wooden parts in oak uniq clear, oiled - Made of recycled wood
Weitere Beimöbel siehe Register 2 | Autres accessoires voir registre 2 |
 Further accessories see index 2

				Dimension cm
Dorma	Kopfteil, Buffalo grey 721	Tête de lit, Buffalo grey 721	Headboard, Buffalo grey 721	140, 160, 180, 200
Inca	Kopfteil	Tête de lit	Headboard	140/160, 180/200
Nakio	Kissen (2er Set) Buffalo grey 721	Coussins (set de 2) Buffalo grey 721	Cushions (set of 2) Buffalo grey 721	55/18/14
Lica	Nachttisch	Table de nuit	Bedside table	50/41/36



NO TIME TO WASTE
 Mehr Informationen auf Seite 5.2
 Plus d'informations à la page 5.2
 More information on page 5.2

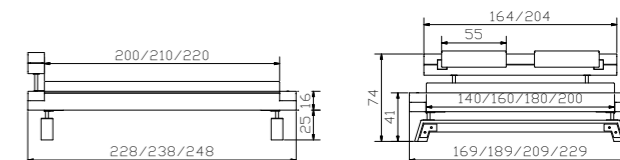





				Dimension cm
Calino	Kommode	Commode	Chest of drawers	105/46/71
Jesa	Nachttisch	Table de nuit	Bedside table	50/41/36

				Dimension cm
Loft 18	Rahmen Breiten Längen Winkel (8er-Set)	Cadre Largeurs Longueurs Équerres (set de 8)	Frame Widths Lengths Brackets (set of 8)	90, 100, 120, 140, 160, 180, 200 200, 210, 220
Gola	Füße Höhen	Pieds Hauteurs	Feet Heights	20, 25
Varus	Kopfteil	Tête de lit	Headboard	140, 160, 180, 200
Ravo	Kissen, Casual carbon 334	Coussin, Casual carbon 334	Cushion, Casual carbon 334	140, 160, 180, 200

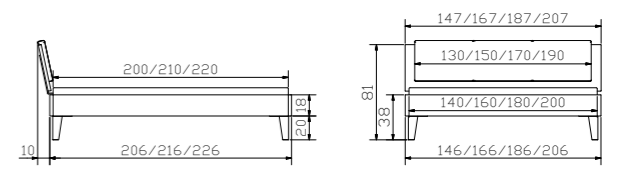
Alle Holzteile in Akazie Vintage brown, lackiert | Toutes les parties en bois en acacia Vintage brown, laqué | All wooden parts in acacia Vintage brown, lacquered
 Weitere Beimöbel siehe Register 2 | Autres accessoires voir registre 2 | Further accessories see index 2





				Dimension cm
Topa bronze	Bank inkl. Kissen Cyclo cream 730	Banquette, Coussin incl. Cyclo cream 730	Bench, Cushion incl. Cyclo cream 730	144/44/38
Scola	Sekretär, höhenverstellbar Schreibtischunterlage in Casual carbon 334	Secrétaire, réglable en hauteur Équerres (set de 4) Sous-main de bureau en Casual carbon 334	Bureau, adjustable in height Brackets (set of 8) Deskpad in Casual carbon 334	120/70/72-88
Case used	Winkel (4er-Set)			
Carpi	Nachtisch höhenverstellbar 34–53 cm	Table de nuit réglable en hauteur 34–53 cm	Beside table adjustable in height 34–53 cm	52/42/34-53
Smart black	Leselampe (2er Set) 12V DC, 30 LED warm	Lampe de lecture (Set de 2) 12V DC, 30 LED warm	Reading lamp (Set of 2) 12V DC, 30 LED warm	

Alle Holzteile in Akazie Vintage grey, lackiert | Toutes les parties en bois en acacia Vintage grey, laqué | All wooden parts in acacia Vintage grey, lacquered
Leselampen und weitere Beimöbel siehe Register 2 | Lampes de lecture et autres accessoires voir registre 2 | Reading lamps and further accessories see index 2

				Dimension cm
Loft 18	Rahmen Breiten Längen	Cadre Largeurs Longueurs	Frame Widths Lengths	90, 100, 120, 140, 160, 180, 200 200, 210, 220
Fasio bronze	Füsse Höhe	Pieds Hauteur	Feet Height	20
Boga	Kopfteil, Cyclo cream 730 siehe Register 1	Tête de lit, Cyclo cream 730 voir registre 1	Headboard, Cyclo cream 730 see index 1	90, 100, 120, 140, 160, 180, 200

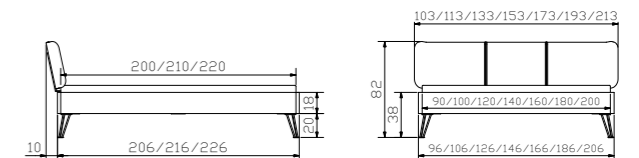



				Dimension cm
Malta	Kopfteil Alpina smoke 394 Alpina lightgrey 390 siehe Register 1	Tête de lit Alpina smoke 394 Alpina lightgrey 390 voir registre 1	Headboard Alpina smoke 394 Alpina lightgrey 390 see index 1	120, 140, 160, 180, 200
Calino	Kommode	Commode	Chest of drawers	105/46/71

				Dimension cm
Loft 18	Rahmen Breiten Längen	Cadre Largeurs Longueurs	Frame Widths Lengths	90, 100, 120, 140, 160, 180, 200
Case 8 used	Winkel (8er-Set)	équerres (Set de 8)	Brackets (Set of 8)	200, 210, 220
Ivio	Füsse Höhen	Pieds Hauteurs	Feet Heights	10, 20, 25
Malta	Kopfteil, Capo 763 Linen siehe Register 1	Tête de lit, Capo 763 Linen voir registre 1	Headboard, Capo 763 Linen see index 1	120, 140, 160, 180, 200
Roll-Box	Bettkasten, weiss Höhen	Tiroir de lit, blanc Hauteurs	Bed drawer, white Heights	137/67 19, 24
Jago	Nachttisch	Table de nuit	Bedside table	50/41/16

Alle Holzteile in Eiche uniq clear, geölt - Hergestellt aus recycletem Holz | Toutes les parties en chêne uniq clear, huilé - Huilé fabriqué en bois recyclé | All wooden parts in oak uniq clear, oiled - Made of recycled wood

Weitere Beimöbel siehe Register 2 | Autres accessoires voir registre 2 | Further accessories see index 2



NO TIME TO WASTE

Mehr Informationen auf Seite 5.2
Plus d'informations à la page 5.2
More information on page 5.2

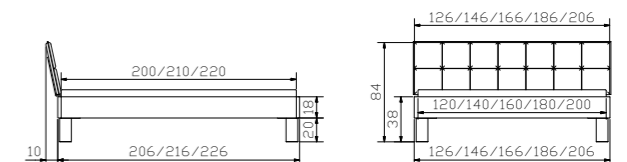



Dimension cm

Scola	Sekretär, höhenverstellbar Schreibtischunterlage in Casual carbon 334	Secrétaire, réglable en hauteur Équerres (set de 4) Sous-main de bureau en	Bureau, adjustable in height Brackets (set of 8) Deskpad in Casual carbon 334	120/70/72-88
Calino	Kommode	Commode	Chest of drawers	105/46/71
Lica	Nachttisch	Table de nuit	Bedside table	50/41/36
Coban	Bank	Banquette	Bench	144/44/36
Curty	Baldachin-Vorhang (3er Set) Baumwolle weiss	Rideau de baldaquin (set de 3) Coton blanc	Curtain of canopy (set of 3) Cotton white	272/185 (3x)

Dimension cm

Loft 18	Rahmen Breiten Längen	Cadre Largeurs Longueurs	Frame Widths Lengths	90, 100, 120, 140, 160, 180, 200 200, 210, 220
Cielo anthracit	Baldachin Breiten Längen Höhe, Boden bis Unterkante Bettrahmen	Baldaquin Largeurs Longueurs Hauteur, Du sol au bord Inférieur du cadre du lit	Canopy Widths Lengths Height, Floor to lower Edge of bed frame	120, 140, 160, 180, 200 200, 210, 220 20
Obag	Kopfteil, Casual carbon 334 siehe Register 1	Tête de lit, Casual carbon 334 voir registre 1	Headboard, Casual carbon 334 see index 1	140, 160, 180, 200



Curty

Alle Holzteile in Akazie Vintage brown, lackiert
Toutes les parties en bois en acacia Vintage brown, laqué
All wooden parts in acacia Vintage brown, lacquered
Weitere Beimöbel siehe Register 2
Autres accessoires voir registre 2
Further accessories see index 2

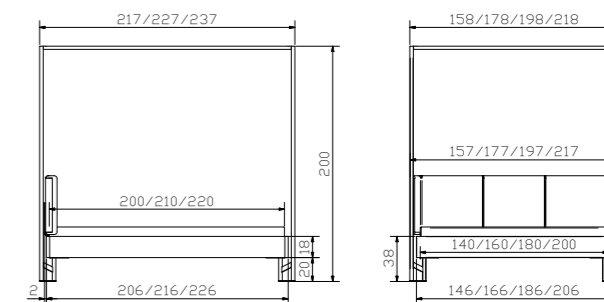



Dimension cm

Loft 18	Rahmen Breiten Längen	Cadre Largeurs Longueurs	Frame Widths Lengths	90, 100, 120, 140, 160, 180, 200 200, 210, 220
Indus iron	Kufen Breiten Höhen	Patins Largeurs Hauteurs	Vats Widths Heights	140, 160, 180, 200 20, 25
Ronna	Kopfteil, Buffalo shale 720 siehe Register 1	Tête de lit, Buffalo shale 720 voir registre 1	Headboard, Buffalo shale 720 see index 1	90/100, 120, 140, 160, 180, 200
Tina chrom	Leselampe (2er Set) 12 V DC, 1 LED	Lampe de lecture (set de 2) 12 V DC, 1 LED	Reading lamp (set of 2) 12 V DC, 1 LED	
Jago	Nachttisch	Table de nuit	Bedside table	50/41/16

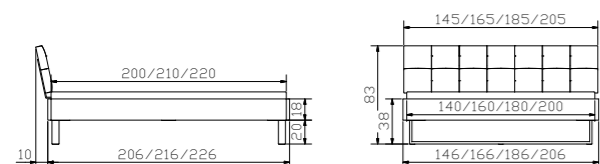

Alle Holzteile in Akazie Vintage brown, lackiert
 Toutes les parties en bois en acacia Vintage brown, laqué
 All wooden parts in acacia Vintage brown, lacquered
Leselampen und weitere Beimöbel siehe Register 2
 Lampes de lecture et autres accessoires voir registre 2
 Reading lamps and further accessories see index 2

Dimension cm

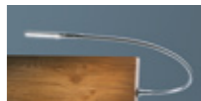
Arcada Arona	Kopfteil Kissen, Buffalo shale 720	Tête de lit Coussin, Buffalo shale 720	Headboard Cushion, Buffalo shale 720	90/100, 120, 140, 160, 180, 200 90/100, 120, 140, 160, 180/200
Smart black	Leselampe (2er Set), schwarz 12V DC, 30 LED warm Dreistufenschaltung	Lampe de lecture (set de 2), noir 12V DC, 30 LED warm interrupteur à 3 crans	Reading lamp (set of 2), black 12V DC, 30 LED warm three step circuit	
Varus Varo	Kopfteil Kissen 2er Set, Tocco creme 711	Tête de lit Set de 2 coussins, Tocco creme 711	Headboard Set of 2 cushions, Tocco creme 711	140, 160, 180, 200 55/10/35
Boa chrom	Leselampe (2er Set) 12V DC, 12 LED kalt weiss	Lampe de lecture (set de 2) 12V DC, 12 LED blanc froid	Reading lamp (set of 2) 12V DC, 12 LED cold white	

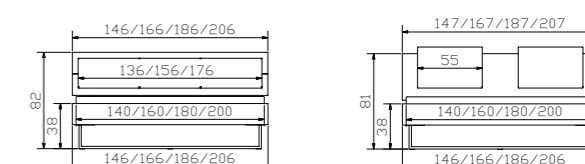



				Dimension cm
Calino	Kommode	Commode	Chest of drawers	105/46/71
Lica	Nachttisch	Table de nuit	Bedside table	50/41/36

				Dimension cm
Loft 18	Rahmen Breiten Längen	Cadre Largeurs Longueurs	Frame Widths Lengths	90, 100, 120, 140, 160, 180, 200 200 (220)
Road used	Füsse fixiert Rollen nur optisch Höhe	Pieds fixes Roulettes uniquement décoration Hauteur	Feet fixed Castors only visual Height	20
Ceneri	Kopfteil, Casual carbon 334 hat Einfluss auf Bettlänge siehe Register 1 Seite 4	Tête de lit, Casual carbon 334 a un impact sur la longueur du lit voir registre 1 page 4	Headboard, Casual carbon 334 affects the length of bed see index 1 page 4	140, 160, 180, 200

Alle Holzteile in Akazie Vintage grey, lackiert | Toutes les parties en bois en acacia Vintage grey, laqué | All wooden parts in acacia Vintage grey, lacquered
 Weitere Beimöbel siehe Register 2 | Autres accessoires voir registre 2 | Further accessories see index 2

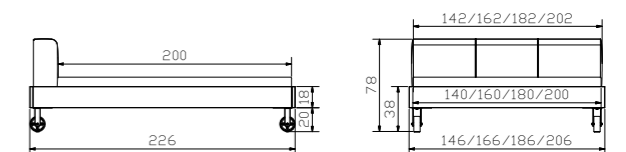



	Nachttisch	Table de nuit	Bedside table	Dimension cm
Dowe	1 Bettkasten	1 Tiroir de lit	1 Bed drawer	45/49/55
Lovie-Box	Breite	Largeur	Width	140
	2 Bettkästen	2 Tiroirs de lit	2 Bed drawers	140, 160, 180, 200
	Breiten	Largeurs	Widths	
	Höhe	Hauteur	Height	25

	Rahmen	Cadre	Frame	Dimension cm
Cone 23	Breiten	Largeurs	Widths	140, 160, 180, 200
	Längen	Longueurs	Lengths	200, 210, 220
Gola	Füße	Pieds	Feet	20, 25
	Höhen	Hauteurs	Heights	
Varus	Kopfteil	Tête de lit	Headboard	140, 160, 180, 200

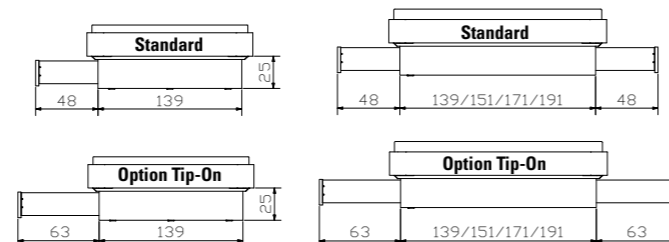

NO TIME TO WASTE
 Mehr Informationen auf Seite 5.2
 Plus d'informations à la page 5.2
 More information on page 5.2

Alle Holzteile in Eiche uniq clear, geölt - Hergestellt aus recycletem Holz
 Toutes les parties en bois en chêne uniq clear, huilé - Fabriqué en bois recyclé
 All wooden parts in oak uniq clear, oiled - Made of recycled wood
Weitere Beimöbel siehe Register 2 | Autres accessoires voir registre 2 |
 Further accessories see index 2

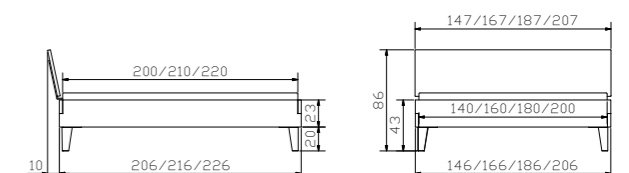



				Dimension cm
Lica	Nachttisch	Table de nuit	Bedside table	50/41/36

				Dimension cm
Cone 23	Rahmen Breiten Längen	Cadre Largeurs Longueurs	Frame Widths Lengths	140, 160, 180, 200 200, 210, 220
Ivio	Füße Höhen	Pieds Hauteurs	Feet Heights	10, 20, 25
Umbia L	Wandpaneel, Boucle fresco 772 nur für Wandmontage siehe Register 1, Seite 5	Panneau mural, Boucle fresco 772 uniquement pour montage mural voir registre 1, page 5	Wallpanel, Boucle fresco 772 wall assembly only see index 1, page 5	153, 173, 193, 213

Alle Holzteile in Akazie Vintage grey, lackiert | Toutes les parties en bois en acacia Vintage grey, laqué | All wooden parts in acacia Vintage grey, lacquered
 Weitere Beimöbel siehe Register 2 | Autres accessoires voir registre 2 | Further accessories see index 2

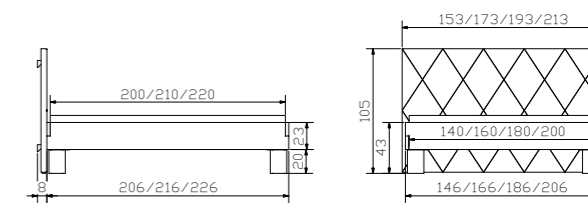



				Dimension cm
Calino	Kommode	Commode	Chest of drawers	105/46/71
Jesa	Nachttisch	Table de nuit	Bedside table	50/41/36

				Dimension cm
Cone 23	Rahmen Breiten Längen	Cadre Largeurs Longueurs	Frame Widths Lengths	140, 160, 180, 200 200, 210, 220
Slid anthracit	Kufen Breiten Höhen	Patins Largeurs Hauteurs	Vats Widths Heights	140, 160, 180, 200 20, 25
Varus	Kopfteil	Tête de lit	Headboard	140, 160, 180, 200

Alle Holzteile in Akazie Vintage brown, lackiert | Toutes les parties en bois en acacia Vintage brown, laqué | All wooden parts in acacia Vintage brown, lacquered
Weitere Beimöbel siehe Register 2 | Autres accessoires voir registre 2 | Further accessories see index 2

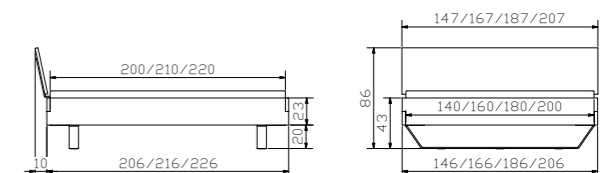



Jago	Nachttisch	Table de nuit	Bedside table	Dimension cm 50/41/16
-------------	------------	---------------	---------------	---------------------------------



Alle Holzteile in Eiche uniq clear, geölt - Hergestellt aus recycletem Holz
 Toutes les parties en bois en chêne uniq clear, huilé - Fabriqué en bois recyclé
 All wooden parts in oak uniq clear, oiled - Made of recycled wood
Weitere Beimöbel siehe Register 2 | Autres accessoires voir registre 2 |
 Further accessories see index 2

Cone 23	Rahmen Breiten Längen	Cadre Largeurs Longueurs	Frame Widths Lengths	Dimension cm 140, 160, 180, 200 200, 210, 220
Jeno used	Füße Höhen	Pieds Hauteurs	Feet Heights	10, 20, 25
Cussina	Kopfteil, Fusio shell 750	Tête de lit, Fusio shell 750	Headboard, Fusio shell 750	140, 160, 180, 200



NO TIME TO WASTE
 Mehr Informationen auf Seite 5.2
 Plus d'informations à la page 5.2
 More information on page 5.2

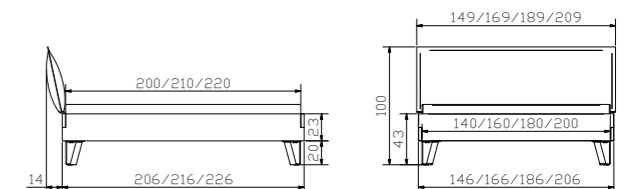



Dimension cm

Coban	Bank	Banquette	Bench	144/44/36
Vano	Kissen, Vintage marone 521	Coussin, Vintage marone 521	Cushion, Vintage marone 521	136/34/4
Quatro	Kommode	Commode	Chest of drawers	45/49/85
Onia	Nachttisch	Table de nuit	Bedside table	45/49/40

Dimension cm

Cone 23	Rahmen Breiten Längen	Cadre Largeurs Longueurs	Frame Widths Lengths	140, 160, 180, 200 200 (210), 210 (220)
Tondo anthracit	Füße Höhe	Pieds Hauteur	Feet Height	20
Cena	Kopfteil, Vintage marone 521 hat Einfluss auf Bettlänge siehe Register 1 Seite 4	Tête de lit, Vintage marone 521 a un impact sur la longueur du lit voir registre 1 page 4	Headboard, Vintage marone 521 affects the length of bed see index 1 page 4	140, 160, 180, 200

Alle Holzteile in Akazie Vintage brown, lackiert | Toutes les parties en bois en acacia Vintage brown, laqué | All wooden parts in acacia Vintage brown, lacquered
Weitere Beimöbel siehe Register 2 | Autres accessoires voir registre 2 | Further accessories see index 2

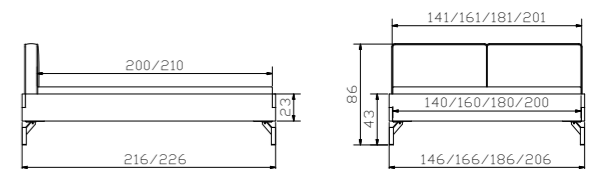



	Dimension cm		
Lovie-Box	1 Bettkasten Breite 2 Bettkästen Breiten Höhe	1 Tiroir de lit Largeur 2 Tiroirs de lit Largeurs Hauteur	1 Bed drawer Width 2 Bed drawers Widths Height
			140 140, 160, 180, 200 25

Anthracit | anthracite

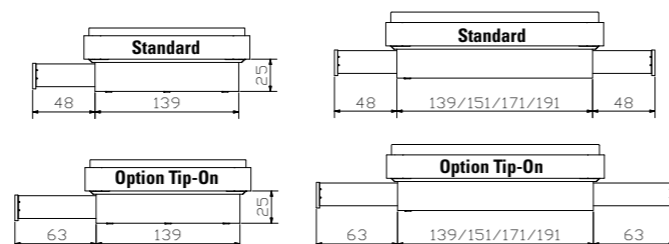

5.46

	Dimension cm			
Cone 23	Rahmen Breiten Längen	Cadre Largeurs Longueurs	Frame Widths Lengths	140, 160, 180, 200 200, 210, 220
Jeno used	Füße Höhen	Pieds Hauteurs	Feet Heights	10, 20, 25
Lumo + Arcada	Kopfteil, Tocco chocolate 712	Tête de lit, Tocco chocolate 712	Headboard, Tocco chocolate 712	140, 160, 180/200
Calino	Kommode	Commode	Chest of drawers	105/46/71
Lica	Nachttisch	Table de nuit	Bedside table	50/41/36



NO TIME TO WASTE
Mehr Informationen auf Seite 5.2
Plus d'informations à la page 5.2
More information on page 5.2

Alle Holzteile in Eiche uniq clear, geölt - Hergestellt aus recycletem Holz
Toutes les parties en bois en chêne uniq clear, huilé - Fabriqué en bois recyclé
All wooden parts in oak uniq clear, oiled - Made of recycled wood
Weitere Beimöbel siehe Register 2 | Autres accessoires voir registre 2 |
Further accessories see index 2

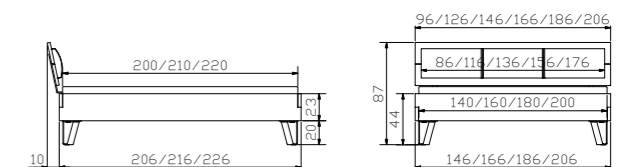

5.47

