



swiss bed concept



# MOVIE-/TOP LINE

Achten Sie auf FSC®-zertifizierte Produkte | Soyez attentifs aux produits certifiés FSC® | Look for FSC®-certified products







# Bettrahmen | Cadre de lit | Bedframe



## Star 16 Movie-Line



**Breiten** | Largeurs | Widths:  
90, 100, 120, 140, 160, 180, 200 cm

**Längen** | Longueurs | Lengths:  
190, 200, 210, 220 cm

**Einlegetiefe** | Hauteur encastrable | Insertion depth:  
16 cm

## Advance 18 Top-Line



**Breiten** | Largeurs | Widths:  
90, 100, 120, 140, 160, 180, 200 cm

**Längen** | Longueurs | Lengths:  
190, 200, 210, 220 cm

**Einlegetiefe** | Hauteur encastrable | Insertion depth:  
18 cm

**Bettrahmen MDF ummantelt in unten genannten Ausführungen. Die Holzstrukturen sind Nachbildungen. Gehrungsteile in alu und chrom inklusive.**

Cadre de lit en MDF dans les exécutions ci-dessous. Les structures en bois sont laminées. Angles décoratifs en alu et chrome inclus.  
Bedframe in MDF in below mentioned executions. All wooden structures are laminated. Deco corners in alu and chrome are included.

## Ausführungen | Exécutions | Executions

### Holz | Bois | Wood

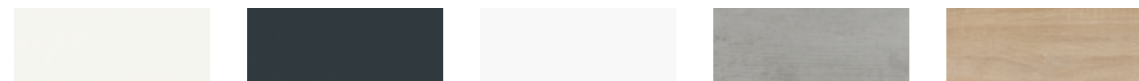

**10 Weiss**  
Blanc  
White

**16 Anthracit**

**35 Hochglanz weiss**  
Blanc brillant  
White highgloss

**49 Beton Nachbildung**  
Béton laminé  
Concrete laminated

**50 Eiche sägerauh natur**  
Chêne brut de sciage naturel  
Oak rough sawn natural

# Traversen | Traverses | Bars

**Wir empfehlen grundsätzlich den Einsatz von Crosstraver (Quertraverse) oder Midtraver (Längstraverse).**

Nous recommandons en général l'utilisation de Crosstraver (traverse transversale) ou Midtraver (traverse centrale).

We recommend basically the insertion of Crosstraver (central cross bar) or Midtraver (central bar).

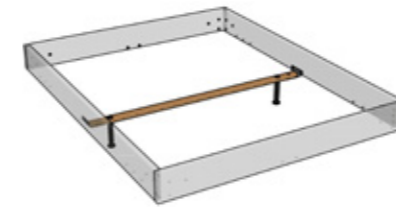

### Crosstraver

Quertraverse | Traverse transversale | Central cross bar

**Für alle Bettbreiten** | Pour toutes les largeurs de lit | For all bed widths

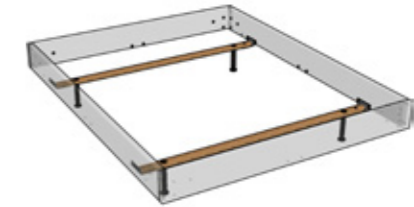

### Crosstraver-Twin

Quertraversen | Traverses transversales | Cross bars

**Für alle Bettbreiten** | Pour toutes les largeurs de lit | For all bed widths

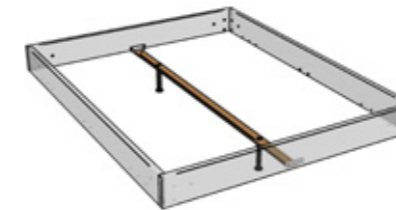

### Midtraver

Längstraverse | Traverse centrale | Central bar

**Für Betten ab Breite 140 cm mit 2 Lattenrosten oder Motorrahmen-einbau** | Pour les lits à partir de 140 cm de largeur avec 2 sommiers ou l'installation d'un cadre motorisé | For beds from 140 cm width with 2 slats or motor frame installation

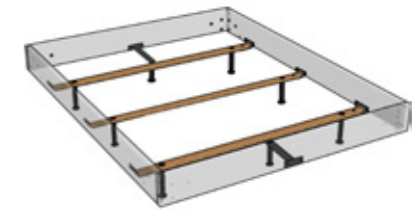

### Crosstraver-XXL

Quertraversen | Traverses transversales | Cross bars

**Für alle Bettbreiten** | Pour toutes les largeurs de lit | For all bed widths

**Übersicht Kompatibilität Traversen siehe Seite 2.12** | Aperçu compatibilité traverses voir page 2.12 | Overview compatibility bars see page 2.12

## Das Bettsystem der unbegrenzten Möglichkeiten

Die Betten unserer Movie-Line und Top-Line sind in zahlreichen Variationen erhältlich. Mit ihrem jugendlichen Esprit und den Bettrahmen-Höhen von 16 und 18 cm verleihen sie jedem Schlafzimmer einen frischen Charakter und ermöglichen ein Einrichten ganz nach Ihren Wünschen. Die höheren Bettrahmen punkten durch den Einsatz von höheren Matratzen und einer grösseren Einlegetiefe.

- 7 Breiten
- 4 Längen
- Spezialgrössen
- Star- und Advance-Bettrahmen in 5 Farben
- Bettrahmen MDF ummantelt, Holzstrukturen sind Nachbildungen
- Gehrungsteile in Alu und Chrom inklusive
- grosse Auswahl an Fussvarianten, Kopfteilen und Wandpaneelen
- Füsse in Komforthöhen erhältlich
- perfekt passende Beimöbel

## Le système de lit des possibilités illimitées

Les lits de notre gamme Movie-Line et Top-Line sont disponibles en de nombreuses variantes. Avec leur esprit jeune et leurs hauteurs de cadre de lit de 14 et 16 cm, ils donnent à chaque chambre un caractère frais et permettent de l'aménager selon vos souhaits. Les cadres de lit plus hauts marquent des points grâce à l'utilisation de matelas plus épais et à une plus grande profondeur d'insertion.

- 7 largeurs
- 4 longueurs
- Dimensions spéciales
- Cadre de lit Star et Advance en 5 couleurs
- Cadre du lit en mdf, les structures en bois sont laminées
- Angles décoratifs en alu et chrome inclus
- grand choix de variantes de pieds têtes de lit et panneaux muraux
- Pieds disponibles en hauteurs de confort
- Meubles d'appoint parfaitement assortis

## The bed system of the unlimited possibilities

The beds of our Movie- and Top-Line are available in numerous variations. With their youthful esprit and bed frame heights of 14 and 16 cm, they give every bedroom a fresh character and make it possible to furnish it according to your wishes. The higher bed frames score points through the use of higher mattresses and a greater insertion depth.

- 7 widths
- 4 lengths
- Special sizes
- Star and Advance bed frames in 5 colours
- Bedframe in mdf, all wooden structures are laminated
- Deco corners in alu and chrome are included
- large selection of foot variations, headboards and wall panels
- Feet available in comfort heights
- perfectly matching side furniture

# Füsse | Pieds | Feet

Holz | Bois | Wood



Holz   Bois   Wood	Masse cm Dimensions cm	Breiten cm Largeurs cm Widths cm	Höhen cm Hauteurs cm Heights cm				Holzfarben Couleurs bois Colours wood		
			10	20	25	30	10	16	50
Cantu	8x8			●	●	●	●		●
Evio		90-200			●			●	
Juve	6-8x6-8			●	●				
Lovie-Box (1 Schublade/Tiroir/Drawer)		90-140			●			●	
Lovie-Box (2 Schublade/Tiroirs/Drawers)		140-200			●			●	
Masi	6x4			●	●				
Practico-Box (inkl. Boden Fond inclus   Bottom included)		90-200			●			●	
Vilo		90-200		●				●	

Practico-Box aus MDF ummantelt. Holzfüsse sind aus Massivholz | Practico-Box en mdf laminé. Pieds en bois massif | Practico-Box in mdf coated. Wooden feet are of solid wood.

## Ausführungen | Exécutions | Executions

Holz | Bois | Wood



**10 Buche weiss deckend, lackiert**  
Hêtre blanc couvrant, laqué  
Beech white covered, lacquered

**16 Buche anthracit deckend, lackiert**  
Hêtre anthracite couvrant, laqué  
Beech anthracit covered, lacquered

**50 Eiche sägerauh natur**  
Chêne brut de sciage naturel  
Oak rough sawn natural

# Füsse | Pieds | Feet

Metall | Métal | Metal



Metall   Métal   Metal	Masse cm Dimensions cm	Breiten cm Largeurs cm Widths cm	Höhen cm Hauteurs cm Heights cm				Metallfarben Couleurs métal Colours metal										Hochglanz Brillant Highgloss								
			10	20	25	30	00	04	10	16	40	41	42	43	45										
Caro	6x6			●	●		●				●													35	
Cielo <sup>▲</sup>		120-200		●						●															
Facil				●																					
Fasio	∅5/9			●							●		●												
Indus	6x2	140-200		●	●						●														
Jeno	12x5		●	●	●					●															
Mico	8x8		●	●	●	●			●																●
Quada	20x6,5			●	●																				●
Reca	24x12		●																						
Road*	∅13			●							●														
Slid	8/1	140-200		●	●							●													
Soko	∅6			●	●																				
Stomp	∅8		●	●	●	●																			
Tondo	∅3,5			●																					

\*Füsse fixiert, Rollen nur optisch | Pieds fixes, roulettes uniquement décoratives | Feet fixed, castors only visual  
 ▲ Curty Vorhang und Vela Baldachin-Tuch siehe Register 2, Seite 2.12 | Curty rideau et Vela tissu de baldachin voir registre 2, page 2.12 | Curty curtain and Vela canopy cloth see index 2, page 2.12

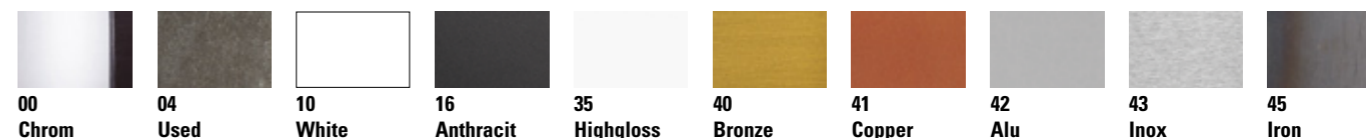

**00 Chrom = Edelstahl poliert** | Acier polié | Stainless steel polished

**04 Used = Stahl galvanisiert** | Acier galvanisé | Steel galvanised

**10 White = Stahl pulverbeschichtet** | Acier thermolaqué | Steel powder-coated

**16 Anthracit = Stahl pulverbeschichtet** | Acier thermolaqué | Steel powder-coated

**40 Bronze = Stahl lackiert** | Acier laqué | Steel lacquered

**41 Copper = Stahl lackiert** | Acier laqué | Steel lacquered

**42 Alu = Stahl pulverbeschichtet** | Acier thermolaqué | Steel powder-coated

**43 Inox = Edelstahl geschliffen** | Acier poncé | Stainless steel ground

**45 Iron = Stahl geflammt, pulverbeschichtet** | Acier flammé, thermolaqué | Steel mottled, powder-coated



# Bettkasten mit Holzkufe | Tiroirs de lit avec patins en bois | Bed drawers with wooden vat



**Lovie-Box + Covero**  **90-140 cm 1 Schublade** | 1 Tiroir | 1 Drawer

**Stauraum** | Compartiment de rangement | Storage space:  
134×61×16 cm

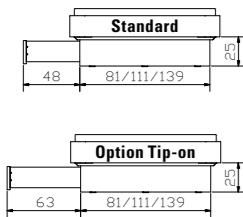

**Standard:** gedämpfter Selbsteinzug Blumotion von BLUM | système d'amortissement Blumotion de BLUM | soft closing runner Blumotion of BLUM  
**Option:** Tip-on-Öffnung mit Vollauszug von BLUM | ouverture Tip-on avec sortie totale de BLUM | opening Tip-on with full extension of BLUM

**Lovie-Box + Saceto**  **140-200 cm 2 Schubladen** | 2 Tiroirs | 2 Drawers

**Stauraum** | Compartiment de rangement | Storage space:  
2×134×61×16 cm

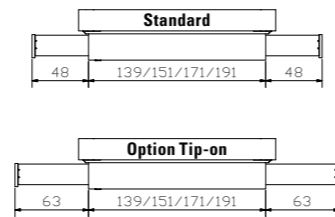

**Roll-Box 20/25** 



Bettkasten in weiss oder anthrazit (Boden weiss)

**Voraussetzung**  
Bettfusshöhe von mindestens 20cm erforderlich

**Optionen**  
Deckel Covero in weiss, Stoffabdeckung Saceto in Polyester grau.

**Roll-Box 20/25 + Covero** 



Tiroir de lit en blanc ou anthracite (fond blanc)

**Condition préalable**  
Une hauteur de pieds de lit d'au moins 20 cm est nécessaire

**Options**  
Couvercle Covero en blanc, tissu de protection Saceto en polyester gris.

**Roll-Box 20/25 + Saceto** 



Bed drawer in white or anthracite (bottom white)

**Condition**  
Feet of bed need a minimum height of 20 cm

**Options**  
Cover Covero in white, tissue of protection Saceto in polyester grey.

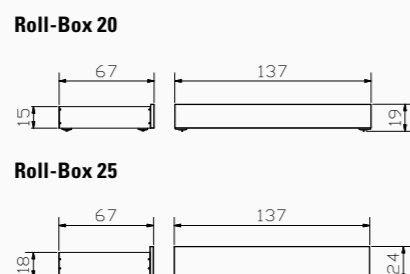

Stauraum   Espace de rangement   Storage space			
Roll-Box 20	=	134×61×13 cm	
Roll-Box 25	=	134×61×16 cm	

# Bettkasten | Coffres à literie | Bedding boxes

**Practico-Box + Star 16**  
+ **Ultrafree-Lift KF**



**Ultrafree-Lift KF**



Box = inkl. Boden, Anwendung siehe Seiten 3.50 – 3.51  
**zu Practico-Box:**  
Lattenrost **Ultrafree-Lift KF**  
Kopf-/Fussverstellung  
Rahmenholme Höhe 7 cm und 28 Federleisten aus Buchenschichtholz  
Gesamthöhe 11 cm

Lattenrost **Econom-move**  
Unverstellbar  
Rahmenholme Höhe 6 cm und 28 Federleisten aus Buchenschichtholz  
Gesamthöhe 9 cm

inkl. Gasdruckfedern und allen Beschlägen

**Details zu Ultrafree-Lift KF und Econom-move**  
siehe Register 14, Seite 14.8

**Practico-Box + Advance 18**  
+ **Econom-move**



**Econom-move**



Box = fond inclus, utilisation voir pages 3.50 – 3.51  
**pour box Practico-Box:**  
Sommier **Ultrafree-Lift KF**  
Tête et pied réglables  
Cadre, hauteur 7 cm et 28 lattes en hêtre multiplis  
Hauteur totale 11 cm

Sommier **Econom-move**  
Non réglable  
Cadre, hauteur 6 cm et 28 lattes en hêtre multiplis  
Hauteur totale 9 cm

Pistons à gaz et toute la quincaillerie inclus

**Détails pour Ultrafree-Lift KF et Econom-move**  
voir registre 14, page 14.8

**Stauraum** | Espace de rangement | Storage space

90 × 200/210/220	=	81 × 190/200/210 × 24 cm
100 × 200/210/220	=	91 × 190/200/210 × 24 cm
120 × 200/210/220	=	111 × 190/200/210 × 24 cm
140 × 200/210/220	=	131 × 190/200/210 × 24 cm
160 × 200/210/220	=	74 × 190/200/210 × 24 (2 x) cm
180 × 200/210/220	=	84 × 190/200/210 × 24 (2 x) cm
200 × 200/210/220	=	94 × 190/200/210 × 24 (2 x) cm

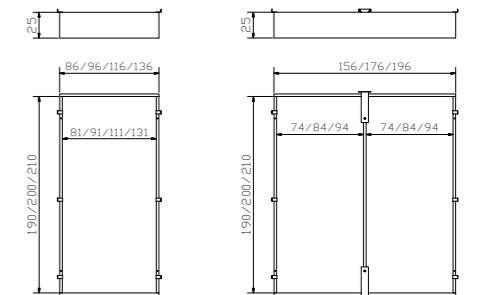

Box = bottom incl., handling see pages 3.50 – 3.51  
**for Practico-Box:**  
Slats **Ultrafree-Lift KF**  
Head/footpiece adjustable  
Frame, height 7 cm and 28 slats are of beech veneer board  
Total height 11 cm

Slats **Econom-move**  
Not adjustable  
Frame, height 6 cm and 28 slats are of beech veneer board  
Total height 9 cm

Pneumatic compression spring and all fittings included

**Details for Ultrafree-Lift KF and Econom-move**  
see index 14, page 14.8

# Himmelbett ohne Grenzen

Lit à baldachin sans frontières | Canopy bed without borders



**Betrahmen**  
Cadre de lit | Bedframe

**Cielo**  
Baldachin | Baldeckin | Canopy

**Kopfteil**  
Tête de lit | Headboard

# Kopfteile | Têtes de lit | Headboards



**Dimension:** 90/100, 120, 140, 160, 180, 200

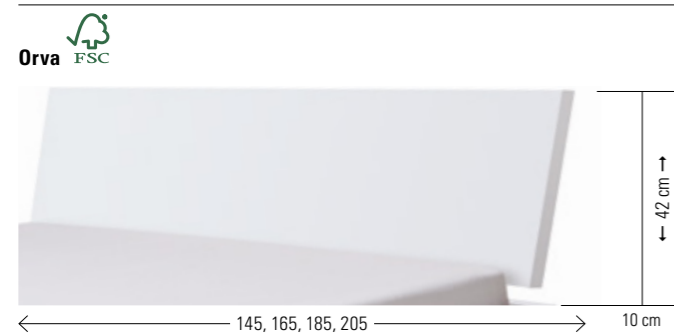

**Dimension:** 140, 160, 180, 200

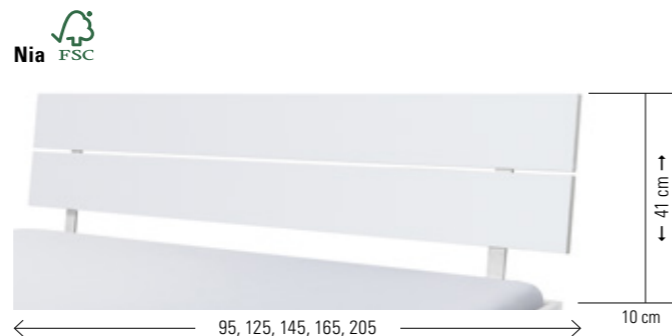

**Dimension:** 90/100, 120, 140, 160, 180/200

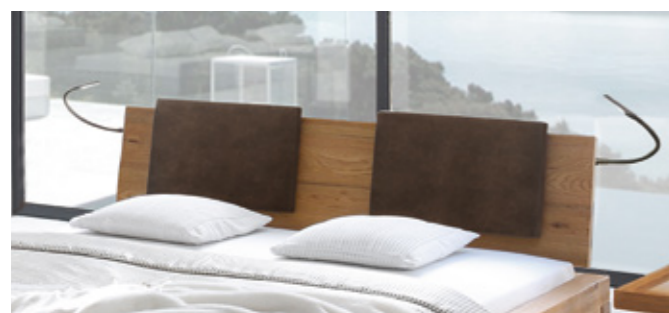

**Gepolsterte Kopfteile, Wandpaneele, Stoffauswahl/Farben siehe Register 1, Seite 1.6 – 1.7, Leselampen siehe Register 2, Seite 2.12**

Têtes de lits rembourrées, panneaux muraux, choix de tissus/couleurs voir registre 1, page 1.6 – 1.7, lampes de lecture voir registre 2, page 2.12

Upholstered headboards, wallpanels, choice of tissues/colours see index 1, page 1.6 – 1.7, reading lamps see index 2, page 2.12

## Holz | Bois | Wood

					<p><b>Die Holzstrukturen sind Nachbildungen</b></p> <p>Les structures bois sont en bois laminé</p> <p>The wood structures are laminated</p>
<p><b>10 Weiss</b> Blanc White</p>	<p><b>16 Anthracit</b></p>	<p><b>35 Hochglanz weiss</b> Blanc brillant White highgloss</p>	<p><b>49 Beton Nachbildung</b> Béton laminé Concrete laminated</p>	<p><b>50 Eiche sägerauh natur</b> Chêne brut de sciage naturel Oak rough sawn natural</p>	

# Kissen zu Kopfteilen | Coussins pour têtes de lit | Cushions for headboards

**Arona + Nuetta**



**Ravo + Orva**



**Varo + Orva**



**Lumo + Nia**



**Suny + Orva**



**Befestigung mit 2 Bändern (Klettverschluss)**

Fixation avec 2 bandes (Velcro®)

Fixation with 2 ribbons (Velcro®fastener)

**Stoffauswahl/Farben für Kissen siehe Register 1, Seiten 1.6–1.7**

Choix de tissus/couleurs pour coussins voir registre 1, pages 1.6–1.7

Choice of tissues/colours for cushions see index 1, pages 1.6–1.7

**Kissen | Coussins | Cushions**

**Effektive Masse cm**  
Dimensions effectives cm  
Effective dimensions cm

**zu Kopfteilen**  
pour têtes de lit  
for headboards

**Breitenmasse cm**  
Dimensions de largeur cm  
Widths dimensions cm

	Effektive Masse cm	zu Kopfteilen	Breitenmasse cm
Arona	86, 116, 136, 156, 176×3,5×25	Nuetta: ●, Nia: ●, Orva: ●	90/100, 120, 140, 160, 180/200
Lumo	86, 116, 136, 156, 176×6×25	Nuetta: ●, Nia: ●, Orva: ●	90/100, 120, 140, 160, 180/200
Ravo	80, 110, 130, 150, 170, 190×3,5×35	Nuetta: ●, Nia: ●, Orva: ●	90/100, 120, 140, 160, 180, 200
Suny (2er Set   set de 2   set of 2)	55×5×40	Nuetta: ●, Nia: ●, Orva: ●	
Varo (2er Set   set de 2   set of 2)	55×10×35	Nuetta: ●, Nia: ●, Orva: ●	

**Alle Kissen in Echtleder haben Zier- sowie Teilungsnähte. Ausnahmen: Suny und Varo, diese Kissen haben lediglich Ziernähte.** | Tous les coussins en cuir véritable ont des coutures décoratives et des coutures de séparation. A l'exception des coussins : Suny et Varo, ces coussins ont uniquement des coutures décoratives. | All cushions in genuine leather have decorative and dividing seams. Exceptions: Suny and Varo, these cushions only have decorative seams.

## Adapter | Adaptateur | Adapter

**Bei hohen Matratzen kann mit dem Verlängerungsadapter das Kopfteil um 9 oder 13 cm erhöht werden.**

La tête de lit peut être rehaussée de 9 ou 13 cm avec l'adaptateur lorsque le matelas est plus épais. With the extension adapter the headboard can be extended 9 or 13 cm if mattresses are high.

**Head-Plus Metall | Métal | Metal**



alu

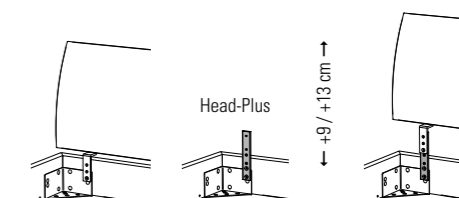



# selezione

## 01

### MODELLAUSWAHL

Sélection du modèle | Model selection

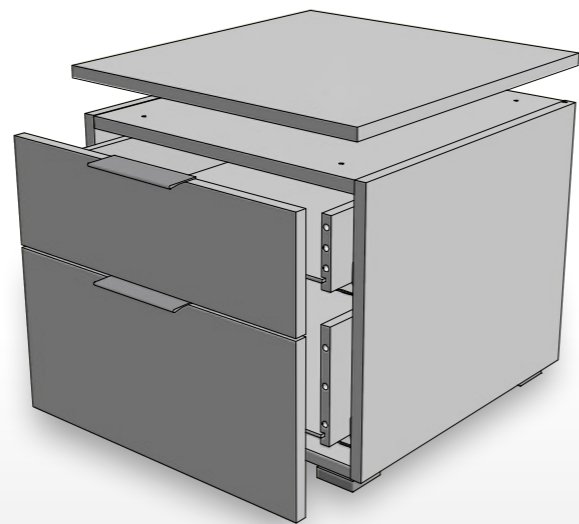

## 02

### KORPUS

Caisson | Body



## 03

### TOP/FRONT

Farben | Couleurs | Colours



## 04

### GRIFFE

Poignées | Handles

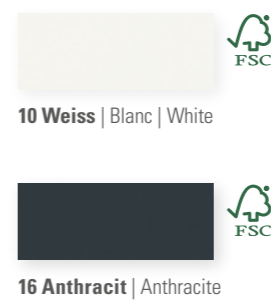
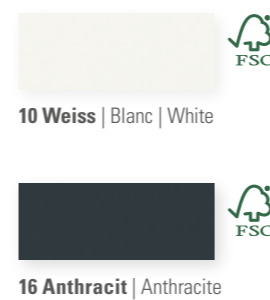
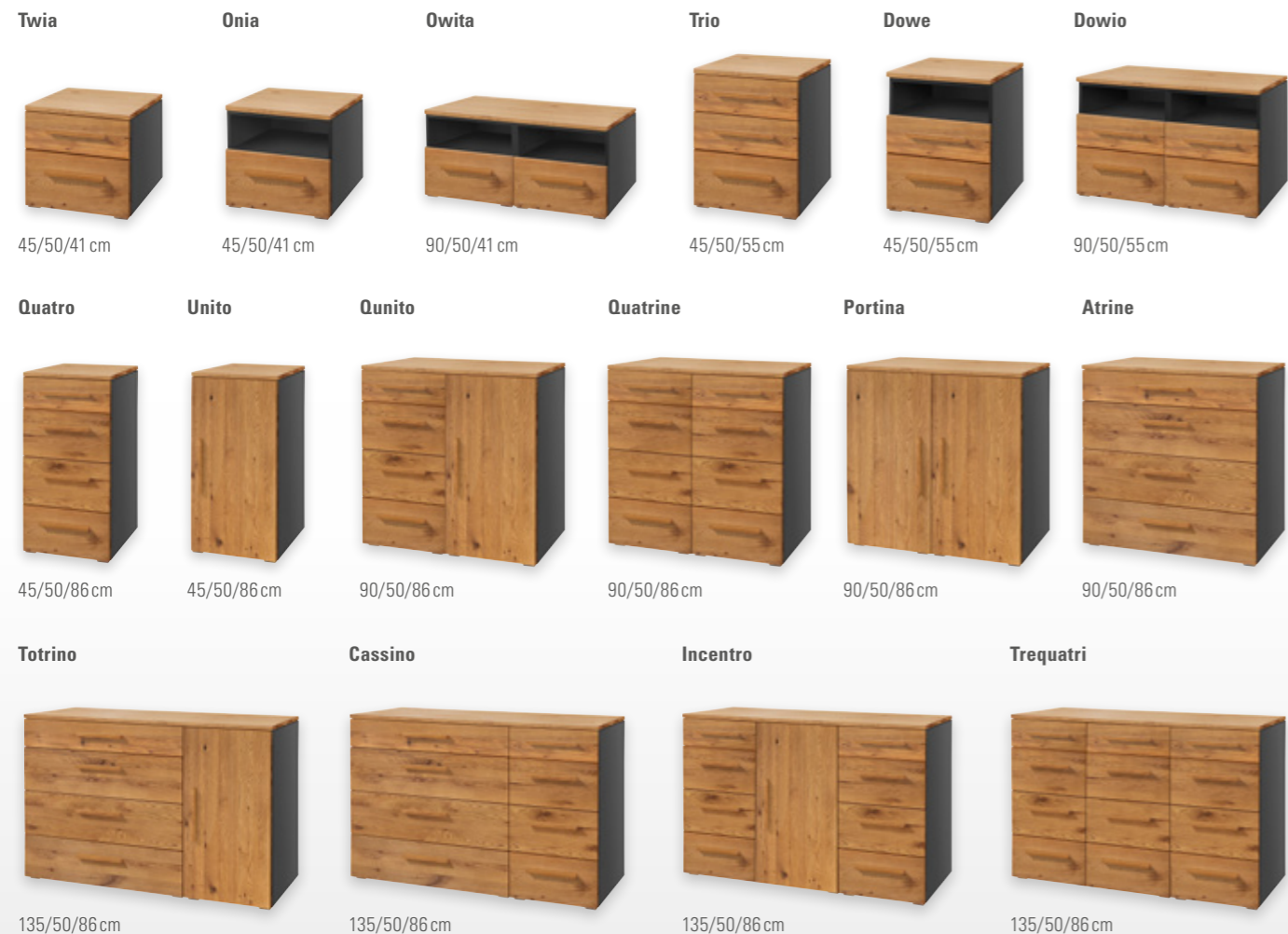

#### STANDARD



#### OPTION

Leg 8 cm    Jone 10 cm    Cila 10 cm



alu



anthracit  
used



anthracit

#### STANDARD



Alu

#### Griff zu Folienfronten

Poignée pour façades en mélaminé  
Handle for foil fronts

#### STANDARD



#### Holzgriff zu Holzfronten

Poignée en bois pour façades en bois  
Wooden handle for wooden fronts

#### OPTION

##### Rivo



Used



Anthracit

#### Metallgriff zu Holzfronten

Poignée en métal pour façades en bois  
Metal handle for wooden fronts

Stellen Sie sich Ihr Wunsch-Beimöbel nach Ihrem Geschmack zusammen: Der Korpus (Abb. 02), in zwei verschiedenen Farbvarianten, lässt sich zu den Front- und Top-Covern (Abb. 03) in acht Holz- und Farbausführungen kombinieren. Die Beimöbel können zerlegt oder teilmontiert bestellt werden. Bei zusammengesetzten Möbeln (z. B. Qunito, Incentro, ...) muss der Deckel noch montiert werden. Bei Kommoden mit Türen ist jeweils ein Einlegeboden vorhanden, Türöffnung nach links oder rechts möglich. Zusätzliche Böden sind erhältlich.

Composez le meuble d'appoint de vos rêves selon vos goûts : Le caisson (ill. 02), disponible en 2 variantes de couleurs, peut être combiné avec les façades et couvercles supérieurs (ill. 03) en 8 finitions de bois et de coloris. Les meubles d'appoint peuvent être commandés en kits ou assemblés. Pour les meubles assemblés (p. ex. Qunito, Incentro, ...) le couvercle doit encore être fixé. Les commodes avec portes sont équipées d'une étagère, ouverture de la porte possible à gauche ou à droite. Si besoin, des étagères supplémentaires sont disponibles.

Put together the side furniture you want according to your own taste: The body (fig. 02), in two different colour versions, can be combined with the front and top covers (fig. 03) in eight wood and colour versions. The furniture can be ordered disassembled or assembled. For assembled furniture (e.g. Qunito, Incentro, ...) the top cover must still be fitted. Chests of drawers with doors have one shelf, door opening possible to the left or right. Additional shelves are available.



**Kombinationsbeispiele und techn. Informationen**  
Exemples et informations  
Examples and informations





# Lattenroste | Sommier | Slats



## Dritto U

**U = Unverstellbar**  
Non réglable  
Not adjustable

**Rahmenholme und 14 Federleisten aus Buchenschichtholz**  
Cadre et 14 lattes en hêtre multiplis  
Frame and 14 slats are of beech veneer board

**Starre Lagerung**  
Suspension rigide  
Rigid suspension

**Längen** | Longueurs | Lengths

200

**Höhe** | Hauteur | Height: 6 cm

**Keine Sondermasse möglich** | Dimensions spéciales non disponibles |  
No special sizes possible

**Breiten** | Largeurs | Widths

80	90	100	120	140
●	●	●	●	●



## Flexo K

**K = Kopfteil manuell 13-fach verstellbar**  
Réglage manuel de la tête en 13 positions  
Head piece manually adjustable in 13 positions

**Rahmenholme und 28 Federleisten aus Buchenschichtholz**  
Cadre et 28 lattes en hêtre multiplis  
Frame and 28 slats are of beech veneer board

**Flexible Lagerung**  
Suspension flexible  
Flexible suspension

**Schulterkomfortzone**  
Zone de confort des épaules  
Comfort zone for shoulders

**Mittelzonenverstärkung**  
Zone médiane renforcée  
Reinforcement of the middle zone



**Längen** | Longueurs | Lengths

200, 210, 220

**Höhe** | Hauteur | Height: 9 cm

**Keine Sondermasse möglich** | Dimensions spéciales non disponibles |  
No special sizes possible

**Breiten** | Largeurs | Widths

80	90	100	120	140
●	●	●	●	●



## Ultrafree RF

**RF = Rücken- und Fussteil manuell je 13-fach verstellbar**  
Réglage manuel pour le haut du corps et les jambes en 13 positions  
Back and foot sections manually adjustable in 13 positions

**Rahmenholme und 30 Federleisten aus Buchenschichtholz**  
Cadre et 30 lattes en hêtre multiplis  
Frame and 30 slats are of beech veneer board

**Details siehe Seite 14.2–14.3**  
Détails voir page  
Details see page:

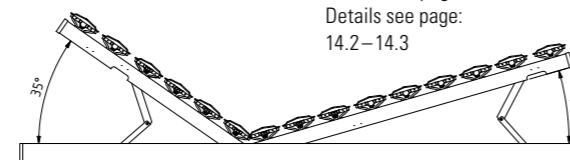

**Längen** | Longueurs | Lengths

200, 210, 220

**Höhe** | Hauteur | Height: 10 cm

**Keine Sondermasse möglich** | Dimensions spéciales non disponibles |  
No special sizes possible

**Breiten** | Largeurs | Widths

80	90	100	120	140
●	●	●	●	●

# Matratzen | Matelas | Mattresses

## Novo

**7-Zonen-Kaltschaumkern, Höhe 8 cm in Härtegrad H3 (RG 35) erhältlich**  
7-zones noyau en mousse froide, hauteur 8 cm disponible dans le degré de fermeté f3 (densité 35)  
7-zones core cold foam, height 8 cm available in the degree of hardness H3 (density 35)

**Optimale Unterstützung durch 7-Zonen-Kaltschaum-Noppenprofil in 2.5 cm Stärke**  
Soutien optimal grâce à une mousse 7-zones froide à picots 2.5 cm  
Optimum support through 7-zones cold foam upholstery 2.5 cm with nobs

**Breiten** | Largeurs | Widths 80, 90, 100, 120, 140, 160, 180, 200 cm

**Längen** | Longueurs | Lengths 200, 210, 220 cm

**Höhe** | Hauteur | Height 16 cm

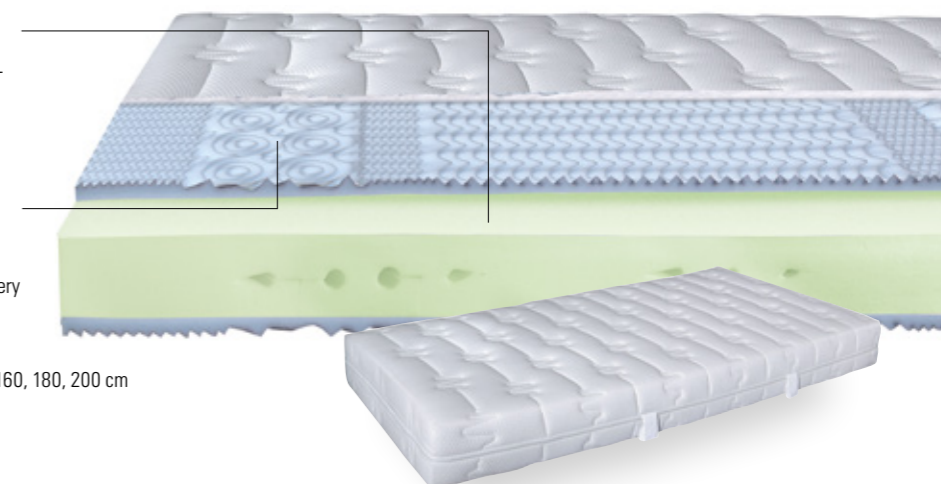

## Ultraconfort

**7-Zonen-Kaltschaumkern, Höhe 12 cm in den Härtegraden H3 (RG 45) und H4 (RG 50) erhältlich**  
7-zones noyau en mousse froide, hauteur 12 cm disponible dans les degrés de fermeté f3 (densité 45) et f4 (densité 50)  
7-zones core cold foam, height 12 cm available in the degrees of hardness H3 (density 45) and H4 (density 50)

**Optimale Unterstützung und Klimatisierung durch 4 cm Soft-Kaltschaum-Auflage RG 60**  
Soutien optimal et climatisation idéale grâce à une mousse froide souple 4 cm densité 60  
Optimum support and climate regulation through 4 cm soft cold foam upholstery density 60

**Breiten** | Largeurs | Widths 80, 90, 100, 120, 140, 160, 180, 200 cm

**Längen** | Longueurs | Lengths 190, 200, 210, 220 cm

**Höhe** | Hauteur | Height 21 cm

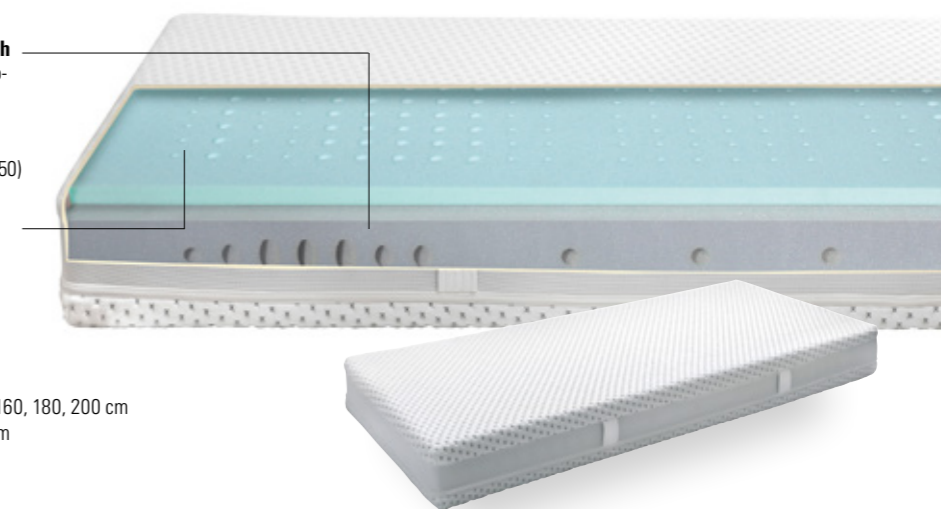

## Ultramotion

**7-Zonen-Kaltschaum-Tröpfchenkern mit Querbelüftung und Schulterzone, Höhe 20 cm in den Härtegraden H2 (RG 53), H3 (RG 53) und H4 (RG 45) erhältlich**

7-zones noyau de gouttelettes en mousse froide avec ventilation transversale et zone pour les épaules, hauteur 20 cm disponible dans les degrés de fermeté f2 (densité 53), f3 (densité 53) et f4 (densité 45)  
7-zones cold foam droplet core with lateral ventilation and shoulder zone, height 20 cm available in the degrees of hardness H2 (density 53), H3 (density 53) and H4 (density 45)

**Breiten** | Largeurs | Widths 80, 90, 100, 120, 140, 160, 180, 200 cm

**Längen** | Longueurs | Lengths 190, 200, 210, 220 cm

**Höhe** | Hauteur | Height 23 cm



**Informationen zu Matratzenbezügen und weitere Lattenroste und Matratzen siehe Register 14**

Informations sur les housses de matelas et autres sommiers et matelas, voir registre 14  
Information on mattress covers and other slatted frames and mattresses, see index 14









Dimension cm

<b>Twia</b>	Nachttisch	Table de nuit	Bedside table	45/49/40
<b>Atrine</b>	Kommode	Commode	Chest of drawers	90/49/85

Dimension cm

<b>Star 16</b>	Rahmen Breiten Längen	Cadre Largeurs Longueurs	Frame Widths Lengths	140, 160, 180, 200 190, 200, 210, 220
<b>Mico chrom</b>	Füsse Höhen	Pieds Hauteurs	Feet Heights	10, 20, 25, 30
<b>Orva</b> <b>Varo</b>	Kopfteil Kissen (2er Set) Alpina lightgrey 390	Tête de lit Coussins (set de 2) Alpina lightgrey 390	Headboard Cushions (set of 2) Alpina lightgrey 390	140, 160, 180, 200 55/10/35

Alle Holzteile in Hochglanz weiss oder weiss | Toutes les parties en bois en blanc brillant ou blanc | All wooden parts in white highgloss or white  
 Weitere Beimöbel siehe Register 2 | Autres accessoires voir registre 2 | Further accessories see index 2

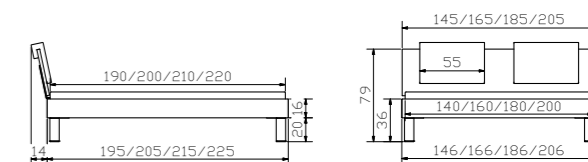





**Lovie-Box**

1 Bettkasten  
Breiten  
2 Bettkästen  
Breiten  
Höhe

1 Tiroir de lit  
Largeurs  
2 Tiroirs de lit  
Largeurs  
Hauteur

1 Bed drawer  
Widths  
2 Bed drawers  
Widths  
Height

**Dimension cm**

90, 100, 120, 140  
140, 160, 180, 200  
25



**Star 16**

Rahmen  
Breiten  
Längen

Cadre  
Largeurs  
Longueurs

Frame  
Widths  
Lengths

**Dimension cm**

120, 140, 160, 180, 200  
190, 200, 210, 220

**Tondo alu**

Füße  
Höhe

Pieds  
Hauteur

Feet  
Height

20

**Malta**

Kopfteil Velluto grey 740

Tête de lit Velluto grey 740

Headboard Velluto grey 740

120, 140, 160, 180, 200

**Onia**

Nachttisch

Table de nuit

Bedside table

45/49/40

**Alle Holzteile in weiss** | Toutes les parties en bois en blanc | All wooden parts in white

**Weitere Beimöbel siehe Register 2** | Autres accessoires voir registre 2 | Further accessories see index 2

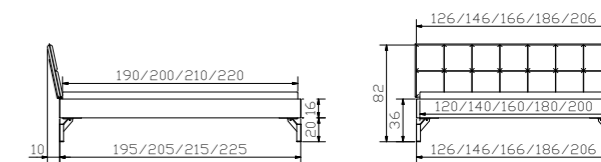





				Dimension cm
<b>Dowe</b>	Nachttisch	Table de nuit	Bedside table	45/49/55
<b>Roll-Box 25</b>	Bettkasten, weiss	Tiroir de lit, blanc	Bed drawer, white	137/67/24

				Dimension cm
<b>Star 16</b>	Rahmen Breiten Längen	Cadre Largeurs Longueurs	Frame Widths Lengths	140, 160, 180, 200 190, 200, 210, 220
<b>Indus iron</b>	Kufen Breiten Höhen	Patins Largeurs Hauteurs	Vats Widths Heights	140, 160, 180, 200 20, 25
<b>Orva Varo</b>	Kopfteil Kissen (2er Set), Casual olive 333	Tête de lit Coussins (set de 2), Casual olive 333	Headboard Cushions (set of 2), Casual olive 333	140, 160, 180, 200 55/10/35

**Alle Holzteile in Eiche sägerauh natur oder weiss** | Toutes les parties en bois en chêne brut de sciage naturel ou blanc | All wooden parts in oak rough sawn natural or white  
**Weitere Beimöbel siehe Register 2** | Autres accessoires voir registre 2 | Further accessories see index 2

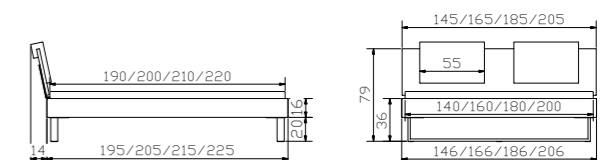





				Dimension cm
<b>Onia</b>	Nachttisch	Table de nuit	Bedside table	45/49/40

				Dimension cm
<b>Star 16</b>	Rahmen Breiten Längen	Cadre Largeurs Longueurs	Frame Widths Lengths	90, 100, 120, 140, 160, 180, 200 190, 200, 210, 220
<b>Caro alu</b>	Füße Höhen	Pieds Hauteurs	Feet Heights	20, 25
<b>Nia</b>	Kopfteil	Tête de lit	Headboard	90/100, 120, 140, 160, 180/200

**Alle Holzteile in Beton Nachbildung oder weiss** | Toutes les parties en bois en béton laminé ou blanc | All wooden parts in concrete laminated or white  
**Weitere Beimöbel siehe Register 2** | Autres accessoires voir registre 2 | Further accessories see index 2

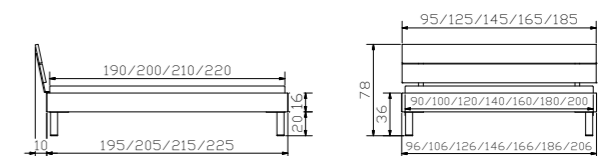





**Dimension cm**

<b>Twia</b>	Nachttisch	Table de nuit	Bedside table	45/49/40
-------------	------------	---------------	---------------	----------

**Dimension cm**

<b>Star 16</b>	Rahmen Breiten Längen	Cadre Largeurs Longueurs	Frame Widths Lengths	90, 100, 120, 140, 160, 180, 200 190, 200, 210, 220
<b>Caro alu</b>	Füße Höhen	Pieds Hauteurs	Feet Heights	20, 25
<b>Nia</b>	Kopfteil	Tête de lit	Headboard	90/100, 120, 140, 160, 180/200

**Alle Holzteile in weiss** | Toutes les parties en bois en blanc | All wooden parts in white

**Weitere Beimöbel siehe Register 2** | Autres accessoires voir registre 2 | Further accessories see index 2

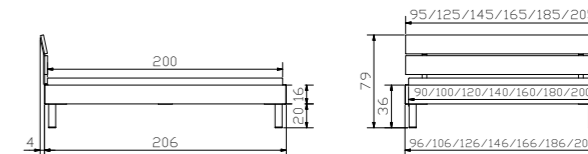





				Dimension cm
<b>Atrine</b>	Kommode	Commode	Chest of drawers	90/49/85
<b>Twia</b>	Nachttisch	Table de nuit	Bedside table	45/49/40

				Dimension cm
<b>Star 16</b>	Rahmen Breiten Längen	Cadre Largeurs Longueurs	Frame Widths Lengths	140, 160, 180, 200 190, 200, 210, 220
<b>Juve</b>	Füsse Höhen	Pieds Hauteurs	Feet Heights	20, 25
<b>Orva</b> <b>Suny</b>	Kopfteil Kissen (2er Set) Capo rose 762	Tête de lit Coussins (set de 2) Capo rose 762	Headboard Cushions (set of 2) Capo rose 762	140, 160, 180, 200 55/6/40

Alle Holzteile in weiss | Toutes les parties en bois en blanc | All wooden parts in white

Weitere Beimöbel siehe Register 2 | Autres accessoires voir registre 2 | Further accessories see index 2

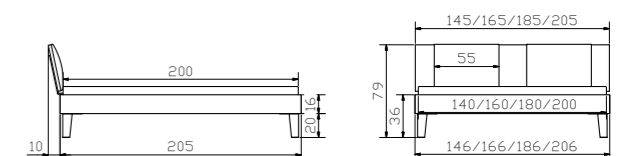





Alle Holzteile in weiss | Toutes les parties en bois en blanc | All wooden parts in white

Weitere Beimöbel siehe Register 2 | Autres accessoires voir registre 2 | Further accessories see index 2

### Curty

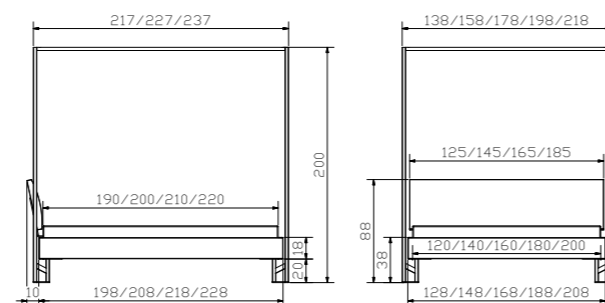

				Dimension cm
<b>Advance 18</b>	Rahmen Breiten Längen	Cadre Largeurs Longueurs	Frame Widths Lengths	120, 140, 160, 180, 200 190, 200, 210, 220
<b>Cielo white</b>	Baldachin Breiten Höhe	Baldaqin Largeurs Hauteur	Canopy Widths Height	120, 140, 160, 180, 200 20
<b>Lecco</b>	Kopfteil, Campos blanc 372 siehe Register 1	Tête de lit, Campos blanc 372 voir registre 1	Headboard, Campos blanc 372 see index 1	120, 140, 160, 180/200
<b>Vela</b>	Baldachin-Tuch, Baumwolle weiss Breiten Länge	Tissu de baldaqin, coton blanc Largeurs Longueur	Canopy cloth, cotton white Widths Length	120, 140, 160, 180 200
<b>Trio</b>	Nachttisch	Table de nuit	Bedside table	45/49/55





				Dimension cm
<b>Atrine</b>	Kommode	Commode	Chest of drawers	90/49/85
<b>Twia</b>	Nachttisch	Table de nuit	Bedside table	45/49/40
<b>Jone 10 used</b>	Füße Höhe	Pieds Hauteur	Feet Height	10

				Dimension cm
<b>Advance 18</b>	Rahmen Breiten Längen	Cadre Largeurs Longueurs	Frame Widths Lengths	90, 100, 120, 140, 160, 180, 200 190 (200), 200 (210), 210 (220)
<b>Jeno used</b>	Füße Höhen	Pieds Hauteurs	Feet Heights	10, 20, 25
<b>Cena</b>	Kopfteil, Campos blanc 372 hat Einfluss auf Bettlänge siehe Register 1, Seite 4	Tête de lit, Campos blanc 372 a un impact sur la longueur du lit voir registre, page 4	Headboard, Campos blanc 372 affects the length of bed see index 1, page 4	90, 100, 120, 140, 160, 180, 200 90 – 120 = 1 Kissen/Coussin/ Cushion

**Alle Holzteile in weiss oder Eiche sägerauh natur** | Toutes les parties en bois en blanc ou chêne brut de sciage naturel |  
All wooden parts in white or oak rough sawn natural

**Weitere Beimöbel siehe Register 2** | Autres accessoires voir registre 2 | Further accessories see index 2

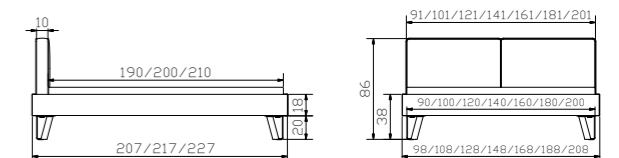





				Dimension cm
<b>Dowe</b>	Nachttisch	Table de nuit	Bedside table	45/49/55
<b>Orva</b>	Kopfteil	Tête de lit	Headboard	140, 160, 180, 200
<b>Varo</b>	Kissen, Alpina anthracit 391	Coussin, Alpina anthracit 391	Cushion, Alpina anthracit 391	55/10/35
<b>Roll-Box 25</b>	Bettkasten, weiss	Tiroir de lit, blanc	Bed drawer, white	137/67/24

				Dimension cm
<b>Advance 18</b>	Rahmen Breiten Längen	Cadre Largeurs Longueurs	Frame Widths Lengths	140, 160, 180, 200 190, 200, 210, 220
<b>Road used</b>	Füsse fixiert Rollen nur optisch Höhe	Pieds fixes Roulettes uniquement décoration Hauteur	Feet fixed Castors only visual Height	20
<b>Orva</b>	Kopfteil	Tête de lit	Headboard	140, 160, 180, 200
<b>Ravo</b>	Kissen, Alpina anthracit 391	Coussin, Alpina anthracit 391	Cushion, Alpina anthracit 391	90/100, 120, 140, 160, 180, 200
<b>Twia</b>	Nachttisch	Table de nuit	Bedside table	45/49/40

**Alle Holzteile in Eiche sägerauh natur, weiss oder anthracit** | Toutes les parties en bois en chêne brut de sciage naturel, blanc ou anthracite |  
All wooden parts in oak rough sawn natural, white or anthracite

**Weitere Beimöbel siehe Register 2** | Autres accessoires voir registre 2 | Further accessories see index 2

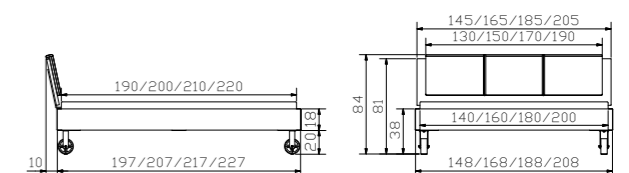





				Dimension cm
<b>Topa</b> anthracit	Bank inkl. Kissen Casual carbon 334	Banquette, coussin incl. Casual carbon 334	Bench, cushion incl. Casual carbon 334	144/44/38
<b>Twia</b>	Nachttisch	Table de nuit	Bedside table	45/49/40
<b>Atrine</b>	Kommode	Commode	Chest of drawers	90/49/85

				Dimension cm
<b>Advance 18</b>	Rahmen Breiten Längen	Cadre Largeurs Longueurs	Frame Widths Lengths	140, 160, 180, 200 190, 200, 210, 220
<b>Tondo</b> anthracit	Füße Höhe	Pieds Hauteur	Feet Height	20
<b>Cussina</b>	Kopfteil, Casual carbon 334 siehe Register 1	Tête de lit, Casual carbon 334 voir registre 1	Headboard, Casual carbon 334 see index 1	140, 160, 180, 200

**Alle Holzteile in anthracit** | Toutes les parties en bois en anthracite | All wooden parts in anthracite  
**Weitere Beimöbel siehe Register 2** | Autres accessoires voir registre 2 | Further accessories see index 2

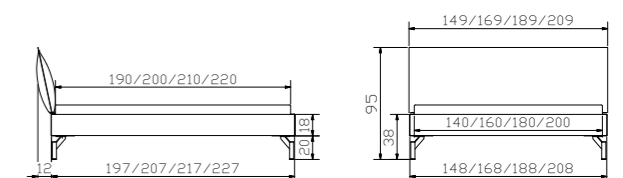





**Dimension cm**

<b>Advance 18</b>	Rahmen Breiten Längen	Cadre Largeurs Longueurs	Frame Widths Lengths	140, 160, 180, 200 190, 200, 210, 220
<b>Indus anthracit</b>	Kufen Breiten Höhen	Patins Largeurs Hauteurs	Vats Widths Heights	140, 160, 180, 200 20, 25
<b>Cussina</b>	Kopfteil, Ranch stone 660 siehe Register 1	Tête de lit, Ranch stone 660 voir registre 1	Headboard, Ranch stone 660 see index 1	140, 160, 180, 200
<b>Twia</b>	Nachttisch	Table de nuit	Bedside table	45/49/40

**Dimension cm**

<b>Advance 18</b>	Rahmen Breiten Längen	Cadre Largeurs Longueurs	Frame Widths Lengths	90, 100, 120, 140, 160, 180, 200 190, 200, 210, 220
<b>Mico anthracit</b>	Füsse Höhen	Pieds Hauteurs	Feet Heights	10, 20, 25, 30
<b>Nuetta</b>	Kopfteil	Tête de lit	Headboard	90/100, 120, 140, 160, 180, 200
<b>Onia</b>	Nachttisch	Table de nuit	Bedside table	45/49/40

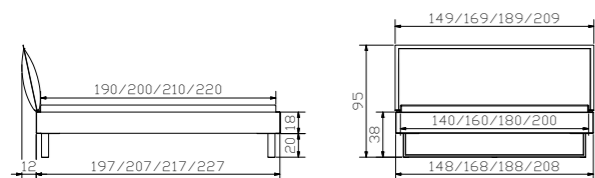

**Alle Holzteile in anthracit** | Toutes les parties en bois en anthracite | All wooden parts in anthracite  
**Weitere Beimöbel siehe Register 2** | Autres accessoires voir registre 2 | Further accessories see index 2

**Alle Holzteile in Beton Nachbildung oder anthracit** | Toutes les parties en bois en béton laminé ou anthracite | All wooden parts in concrete laminated or anthracite  
**Weitere Beimöbel siehe Register 2** | Autres accessoires voir registre 2 | Further accessories see index 2

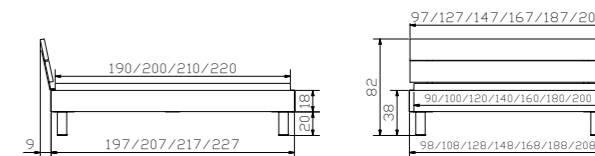





				Dimension cm
<b>Topa</b> anthracit	Bank inkl. Kissen Fusio musk 752	Banquette, coussin incl. Fusio musk 752	Bench, Cushion incl. Fusio musk 752	144/44/38
<b>Twia</b>	Nachttisch	Table de nuit	Bedside table	45/49/40

				Dimension cm
<b>Advance 18</b>	Rahmen Breiten Längen	Cadre Largeurs Longueurs	Frame Widths Lengths	90, 100, 120, 140, 160, 180, 200 190, 200, 210, 220
<b>Slid</b> anthracit	Füße Breiten Höhen	Pieds Largeurs Hauteurs	Feet Widths Heights	140, 160, 180, 200 20, 25
<b>Lecco</b>	Kopfteil Fusio musk 752 siehe Register 1	Tête de lit Fusio musk 752 voir registre 1	Headboard Fusio musk 752 see index 1	90/100, 120, 140, 160, 180/200

**Alle Holzteile in Beton Nachbildung** | Toutes les parties en bois en béton laminé | All wooden parts in concrete laminated  
**Weitere Beimöbel siehe Register 2** | Autres accessoires voir registre 2 | Further accessories see index 2

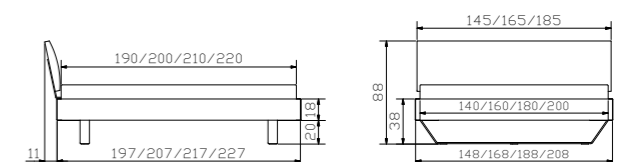





	Dimension cm			
<b>Lovie-Box</b>	1 Bettkasten Breiten 2 Bettkästen Breiten Höhe	1 Tiroir de lit Largeurs 2 Tiroirs de lit Largeurs Hauteur	1 Bed drawer Widths 2 Bed drawers Widths Height	90, 100, 120, 140  140, 160, 180, 200 25

	Dimension cm			
<b>Advance 18</b>	Rahmen Breiten Längen	Cadre Largeurs Longueurs	Frame Widths Lengths	140, 160, 180, 200 190, 200, 210, 220
<b>Cantu</b>	Füße Höhen	Pieds Hauteurs	Feet Heights	20, 25, 30
<b>Orva</b>	Kopfteil	Tête de lit	Headboard	140, 160, 180, 200
<b>Atrine</b>	Kommode	Commode	Chest of drawers	90/49/85
<b>Twia</b>	Nachttisch	Table de nuit	Bedside table	45/49/40
<b>Snake alu</b>	Leselampen (2er Set) 12V DC, 6 LED 3 Beleuchtungsarten	Lampe de lecture (set de 2) 12V DC, 6 LED 3 différentes illuminations	Reading lamp (set of 2) 12V DC, 6 LED 3 different illuminations	

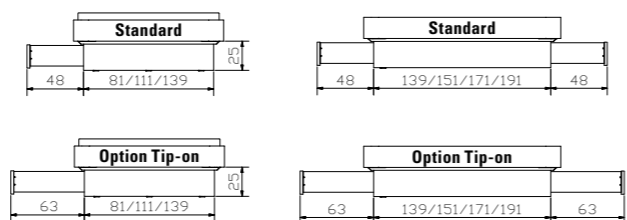

**Alle Holzteile in Eiche sägerauh natur und weiss**  
Toutes les parties en bois en chêne brut de sciage naturel et blanc  
All wooden parts in oak rough sawn natural and white

**Leselampen und weitere Beimöbel siehe Register 2**  
Lampes de lecture et autres accessoires voir registre 2  
Reading lamps and further accessories see index 2

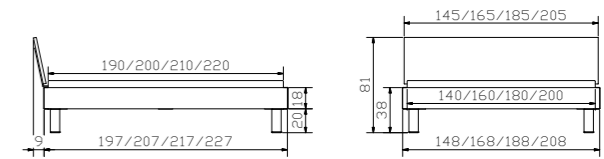





**Dimension cm**

	Kopfteil	Tête de lit	Headboard	Dimension cm
<b>Nuetta</b>	Lampen (2er Set) 12V DC, 6 LED 3 Beleuchtungsarten	Lampes (set de 2) 12V DC, 6 LED 3 différent illuminations	Lamps (set of 2) 12V DC, 6 LED 3 different illuminations	90/100, 120, 140, 160, 180, 200
<b>Snake alu</b>				
<b>Boga</b>	Kopfteil, Alpina navy 393 siehe Register 1	Tête de lit, Alpina navy 393 voir registre 1	Headboard, Alpina navy 393 see index 1	90, 100, 120, 140, 160, 180, 200

**Dimension cm**

	Rahmen Breiten Längen	Cadre Largeurs Longueurs	Frame Widths Lengths	Dimension cm
<b>Advance 18</b>				120, 140, 160, 180, 200 190, 200, 210, 220
<b>Cantu</b>	Füsse Höhen	Pieds Hauteurs	Feet Heights	20, 25, 30
<b>Malta</b>	Kopfteil, Casual olive 333 siehe Register 1	Tête de lit, Casual olive 333 voir registre 1	Headboard, Casual olive 333 see index 1	120, 140, 160, 180, 200

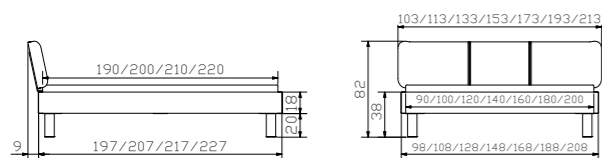

**Alle Holzteile in Eiche sägerauh** | Toutes les parties en bois en chêne brut de sciage naturel | All wooden parts in oak rough sawn natural  
**Lampen und weitere Beimöbel siehe Register 2** | Lampes et autres accessoires voir registre 2 | Lamps and further accessories see index 2

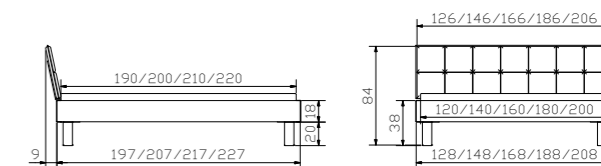





				Dimension cm
<b>Atrine</b>	Kommode	Commode	Chest of drawers	90/49/85
<b>Twia</b>	Nachttisch	Table de nuit	Bedside table	45/49/40

				Dimension cm
<b>Advance 18</b>	Rahmen Breiten Längen	Cadre Largeurs Longueurs	Frame Widths Lengths	140, 160, 180, 200 190, 200, 210, 220
<b>Slid white</b>	Kufen Breiten Höhen	Patins Largeurs Hauteurs	Vats Widths Heights	140, 160, 180, 200 20, 25
<b>Cussina</b>	Kopfteil, Ranch jeans 662 siehe Register 1	Tête de lit, Ranch jeans 662 voir registre 1	Headboard, Ranch jeans 662 see index 1	140, 160, 180, 200

**Alle Holzteile in weiss** | Toutes les parties en bois en blanc | All wooden parts in white  
**Weitere Beimöbel siehe Register 2** | Autres accessoires voir registre 2 | Further accessories see index 2

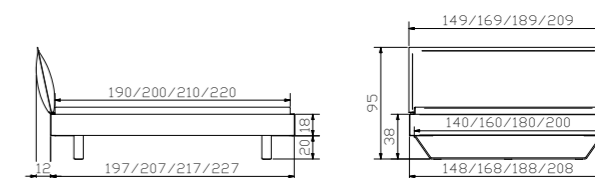





		Dimension cm	
<b>Lovie-Box</b>	1 Bettkasten	1 Tiroir de lit	1 Bed drawer
	Breiten	Largeurs	Widths
	90, 100, 120, 140		
2 Bettkästen	2 Tiroirs de lit	2 Bed drawers	
	Breiten	Largeurs	Widths
140, 160, 180, 200			
Höhe	Hauteur	Height	25

				Dimension cm	
<b>Advance 18</b>	Rahmen	Cadre	Frame		
	Breiten	Largeurs	Widths	140, 160, 180, 200	
	Längen	Longueurs	Lengths	190, 200, 210, 220	
<b>Tondo anthracit</b>	Füße	Pieds	Feet		
	Höhe	Hauteur	Height	20	
<b>Talma</b>	Kopfteil, Boucle ivory 770	Tête de lit, Boucle ivory 770	Headboard, Boucle ivory 770	140, 160, 180, 200	
	siehe Register 1	voir registre 1	see index 1		
<b>Topa anthracit</b>	Bank inkl. Kissen	Banquette, coussin incl.	Bench, cushion incl.	144/44/38	
	Boucle ivory 770	Boucle ivory 770	Boucle ivory 770		
<b>Trio</b>	Nachttisch	Table de nuit	Bedside table	45/49/55	

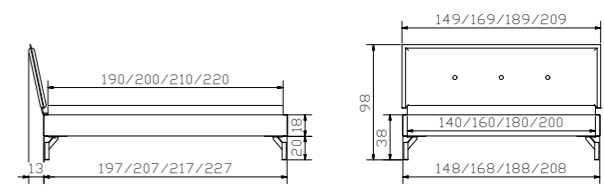
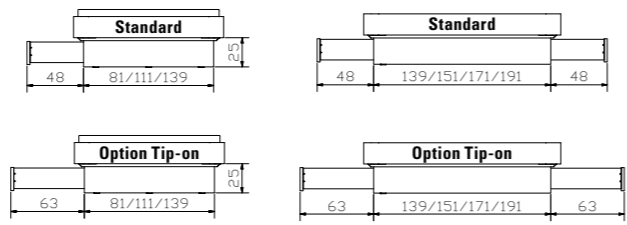

**Alle Holzteile in anthracit** | Toutes les parties en bois en anthracite |  
 All wooden parts in anthracite  
**Weitere Beimöbel siehe Register 2** | Autres accessoires voir registre 2 |  
 Further accessories see index 2





				Dimension cm
<b>Totri</b>	Kommode	Commode	Chest of drawers	135/49/85
<b>Trio</b>	Nachttisch	Table de nuit	Bedside table	45/49/55

				Dimension cm
<b>Advance 18</b>	Rahmen Breiten Längen	Cadre Largeurs Longueurs	Frame Widths Lengths	90, 100, 120, 140, 160, 180, 200 190, 200, 210, 220
<b>Practico-Box</b>	Breiten Längen Höhe	Largeurs Longueurs Hauteur	Widths Lengths Height	90, 100, 120, 140, 160, 180, 200 200, 210, 220 25
<b>Gabo</b>	Kopfteil, Rinovo taupe 701 siehe Register 1	Tête de lit, Rinovo taupe 701 voir registre 1	Headboard, Rinovo taupe 701 see index 1	90, 100, 120, 140, 160, 180, 200



**Details siehe Seite 3.9**  
Détails voir page 3.9  
Details see page 3.9

**Alle Holzteile in weiss** | Toutes les parties en bois en blanc |  
All wooden parts in white

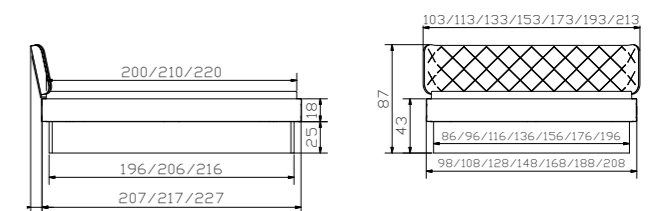





				Dimension cm
<b>Atrine</b>	Kommode	Commode	Chest of drawers	90/49/85
<b>Twia</b>	Nachttisch	Table de nuit	Bedside table	45/49/40
<b>Smart black</b>	Leselampen (2er Set) schwarz 12V DC, 30 LED warm Dreistufenschaltung	Lampes de lecture (set de 2) noir 12V DC, 30 LED warm Interrupteur à 3 crans	Reading Lamp (set of 2) nero 12V DC, 30 LED warm Three step circuit	

				Dimension cm
<b>Advance 18</b>	Rahmen Breiten Längen	Cadre Largeurs Longueurs	Frame Widths Lengths	90, 100, 120, 140, 160, 180, 200 190, 200, 210, 220
<b>Mico anthracit</b>	Füße Höhen	Pieds Hauteurs	Feet Heights	10, 20, 25, 30
<b>Nuetta</b>	Kopfteil	Tête de lit	Headboard	90/100, 120, 140, 160, 180, 200

**Alle Holzteile in anthracit oder Eiche sägerauh natur** | Toutes les parties en bois en anthracite ou chêne brut de sciage naturel |  
All wooden parts in anthracite or oak rough sawn natural

**Leselampen und weitere Beimöbel siehe Register 2** | Lampes de lecture et autres accessoires voir registre 2 | Reading lamps and further accessories see index 2

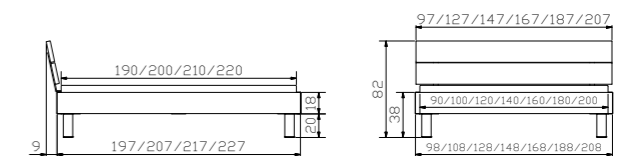





				Dimension cm
<b>Onia</b> anthracit	Nachttisch	Table de nuit	Bedside table	45/49/40

				Dimension cm
<b>Advance 18</b>	Rahmen Breiten Längen	Cadre Largeurs Longueurs	Frame Widths Lengths	90, 100, 120, 140, 160, 180, 200 190, 200, 210, 220
<b>Vilo</b> anthracit	Füße Breiten Höhe	Pieds Largeurs Hauteur	Feet Widths Height	90, 100, 120, 140, 160, 180, 200 20
<b>Nuetta</b>	Kopfteil	Tête de lit	Headboard	90/100, 120, 140, 160, 180, 200

**Alle Holzteile in Beton Nachbildung** | Toutes les parties en bois en béton laminé | All wooden parts in concrete laminated

**Onia: anthracit** | anthracite

**Weitere Beimöbel siehe Register 2** | Autres accessoires voir registre 2 | Further accessories see index 2

